

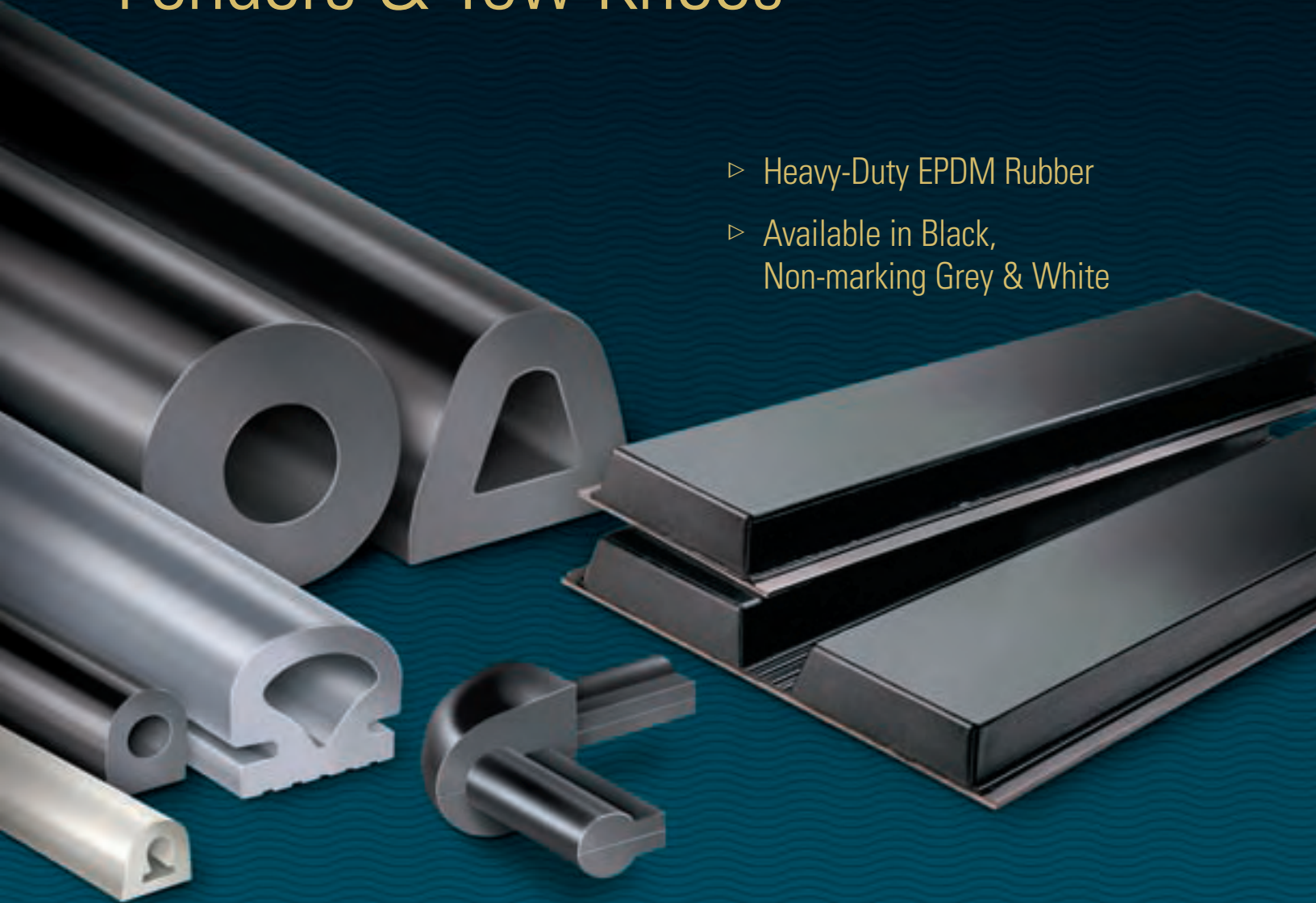

**DURAMAX**<sup>®</sup>

# Commercial Dock Bumpers, Fenders & Tow Knees

- ▷ Heavy-Duty EPDM Rubber
- ▷ Available in Black, Non-marking Grey & White



PRODUCT INFORMATION AND SELECTION GUIDE

**DURAMAX MARINE**<sup>®</sup>



DURAMAX MARINE.  
DELIVERING IMPACT  
PROTECTION SOLUTIONS  
FOR OVER 40 YEARS.





# TABLE OF CONTENTS

## DURAMAX MARINE® FENDERING CAPABILITIES & SERVICES 4-8

### DOCK FENDER PRODUCT INFORMATION & ORDERING 9-27

	<b>100 Series</b> Tapered D-Shape/Key Bore, D-Shape/D-Bore and corresponding Corner Pieces .....9-10
	<b>200 Series</b> Cylindrical/O-Bore .....11
	<b>300 Series</b> Rectangular/O-Bore.....12
	<b>400 Series</b> Wing Type/O-Bore, D-Bore, Solid Bore...13-14
	<b>500 Series</b> Fan Nose .....15
	<b>600 Series</b> Rectangular with Chain .....16-17
	<b>700 Series</b> Cylindrical with Chain.....16-17
	<b>800 Series</b> Corner Guard.....18
	<b>900 Series</b> D-Shape/O-Bore, D-Shape/D-Bore .....19-20
	<b>1000 Series</b> Flat Head.....21
	<b>1100 Series</b> Channel Lock.....22
	<b>2100 Series</b> Trapezoid.....23
	<b>Tow-Knee Pusher Plates</b> .....24-27

### CALCULATING FENDERING SYSTEM REQUIREMENTS 28-33

### LINERITE® COMPOSITE BATTERBOARD 34-35

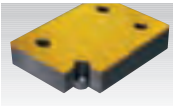

In today's competitive business environment and rising operating costs, the marine industry cannot afford to have vessels out of service because of berthing damage caused by improper fendering systems. For this reason, a good understanding of the latest in fendering technology could prove to be a vessel operator's competitive edge in attracting future business and retaining existing business.

Trust Duramax Marine® to inform you of the latest fendering technology and recommend the appropriate fendering system for your dock or vessel. Our engineers can design the perfect system, then custom fabricate it for quick and easy installation. Or, for a unique application, we will custom design and manufacture a special fendering solution.

For years, our highly effective, reliable fendering solutions have been used in a large variety of military, marine, transportation, highway and bridge, and industrial applications around the world.



# The Duramax Difference

**Unlike suppliers who use SBR (Styrene Butadiene Rubber) and other lower cost compounds to make their products, Duramax Marine® Dock Bumpers and Fenders are manufactured using only high quality EPDM (Ethylene Propylene-Diene-Monomer) rubber. There is a difference.**

## **EPDM quality comes standard.**

EPDM rubber's outstanding properties are unaffected by ozone, which can cause cracking in SBR, natural rubber and butyl, particularly under stress. EPDM also has much greater resistance to sunlight and oxidation. When exposed to natural elements, EPDM should outlast other rubber compounds by a substantial margin. It can perform up to 4x longer resulting in substantial savings on replacement costs. Unless your Dock Bumpers and Fenders are made from EPDM rubber, you're getting an inferior product.

## **EPDM rubber works well in all marine conditions and environments.**

- ▷ **Highly resistant to seawater, steam and many chemicals.**
- ▷ **Resistant to heavy wear & tear.**
- ▷ **Withstands temperatures as high as 150° F and as low as -60° F.**
- ▷ **Excellent color stability.**

<b>Physical Properties of Duramax Marine® Dock Bumpers and Fenders</b>	
<b>MATERIAL:</b>	EPDM (Ethylene Propylene-Diene-Monomer)
<b>RANGE OF SERVICE:</b>	-60° F to 150°F (continuous duty)
<b>DUROMETER:</b>	70±5 shore "A" scale
<b>TENSILE STRENGTH:</b>	2000 minimum p.s.i.
<b>COMPRESSION RECOVERY:</b>	Instantaneous recovery of 90-95% is observed over a 20,000 to 200,000 lb. static load on one foot sample lengths of designated cross-sections. Samples have been compressed 70% by overall height without any damage.
<b>IMPACT RESILIENCY:</b>	As a function of fendering cross-section, high reaction loads with large energy absorptions have been transmitted with no damage experienced.
<b>SHEAR STRENGTH:</b>	For rubber and rubber-like materials, average shear strength is usually taken as 50% of tensile or compressive strength as per application.
<b>WATER ABSORPTION:</b>	Negligible.
<b>LIFE:</b>	Excellent for weather condition in ozone.
<b>DIMENSIONAL TOLERANCE:</b>	±8% on Interior Dimensions. ±4% on Exterior Dimensions.
<b>LENGTH TOLERANCE:</b>	±2% or 1", whichever is greater.

# Quality you can trust

## Complete quality control over the design, engineering and fabrication of our products.

Our experienced engineers design and fabricate the finest impact-protection systems for use all over the world. Every aspect of the process is done under the eyes of our dedicated, qualified professionals. And our Dock Bumpers and Fenders have all been rigorously tested to meet or exceed industry performance standards. That's something you cannot get from third party suppliers.

## Customers trust our consistent dimensional quality.

Duramax® Commercial Dock Bumpers are manufactured to the ASTM D2000 specification and adhere to an industry standard tolerance of  $\pm 4\%$  on outside dimensions and  $\pm 8\%$  on bore dimensions. The length tolerance is  $\pm 2\%$  or  $\pm 1"$  on the length, whichever is greater.

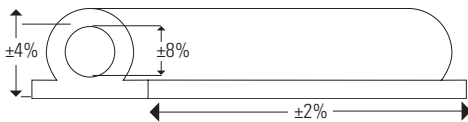

## Large inventory in stock

### Fendering that fits your application, when and where you need it.

We strategically located our vast inventory of fender profiles in 2 locations, Ohio and Louisiana. That means when you need a fendering system, you can rely on us to deliver it faster than industry standards.

### Short lead times on large & short runs.

We typically provide manufacturing with lead times that are shorter than the industry standards. And while some suppliers are only interested in setting up to run large quantities, Duramax Marine® is committed to providing you with any quantity of dock bumper you require.

## We manufacture two basic types of fenders- Extruded Hollow Bore and Extruded Solid.

### Extruded Hollow Rubber

Fenders exhibit higher energy absorption due to greater deflection for given loads. They comprise the larger portion of the fendering industry for both harbor and vessel service.

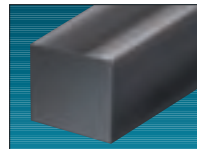
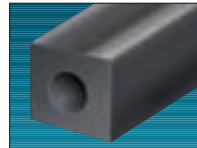

### Extruded Solid Rubber

Fenders have lower energy absorption capabilities with higher reactive loads compared to hollow fender. They are ideal for uses such as ship's belting, protection of fender piles and concrete caps, to name a few.

An **Embedded Chain** is also available as an integral part of the Extruded Solid Rubber Fender. This is a product unique to Duramax Marine®.

## A large variety of sizes, cross-sectional designs and colors ready for immediate delivery.

Duramax Marine's standard fenders are manufactured from black EPDM rubber. Most standard fender cross sections are also available in non-marking grey or white EPDM for commercial and recreational applications. Many cross sections and sizes can also be made in non-marking grey or white for commercial and recreational applications. Our non-marking grey fender is routinely used by both the U.S. Navy and U.S. Coast Guard for applications which require fender that will not leave behind a black streak upon impact. Tug boats and harbor assist tugs working with naval vessels also prefer to use our non-marking grey fenders.

## Selection of Dock Bumper available in 3 colors:

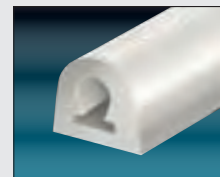
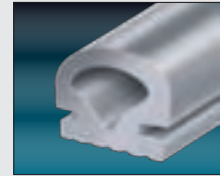
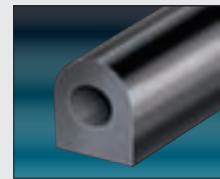

## We're more than just your supplier - we're a business partner you can trust.

- We'll deliver your products faster than industry standards, so costly downtime is minimal.
- We'll strive to give you the best value for your money and the lowest full life cost on your product.
- We'll continually look for innovative, new ways to improve our products so they are easier to install, more reliable and longer lasting with less maintenance.

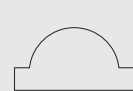



# Customizing To Fit Your Applications

Duramax Marine® has over 40 years of experience in custom design and fabrication of commercial dock bumpers and fenders for vessels. Whether you are replacing an existing system or need a fendering system for new construction, our engineers will work closely with you to custom fabricate the fendering to match your exact installation specifications.

If your fender requirements are unique, we will custom-design and manufacture the perfect system for you.

## Pre-Curving

### Pre-curved Fenders provide stronger impact resistance.

When you need fender mounted on a curved surface, trust Duramax Marine® pre-curved dock bumper sections. Our pre-curved sections are cured with the curve in the part to relieve the stress that will cause the fender to split or tear upon impact.

### The following information is needed when ordering a Pre-curved Fender:

- Specify the Duramax Commercial Dock Bumper type and dimensions
- Radius of the hull =  $R \pm 2$  inches
- The total length of fender against the hull from X to X
- The angle of the curvature =  $A \pm 5$  degrees \*\*  
\*\*If the angle of curvature cannot be determined, dimensions D and W can be substituted for A degrees.
- The thickness (height) of the fender section to be curved = H.

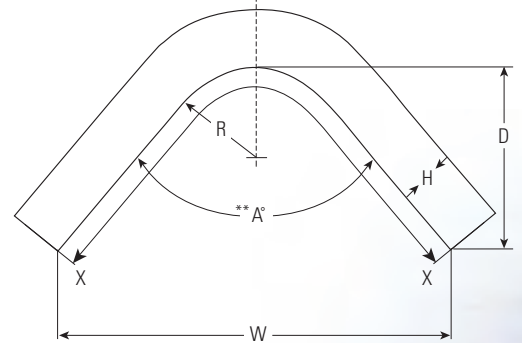

Duramax Marine® recommends that the minimum bending radius (R) is  $\geq 1.5 \times H$ .

Note that pre-curving dock bumper will distort the shape of the bumper at and near the bend. Consult your Duramax Marine® representative to determine if pre-curving is necessary for your installation.



## Custom Cutting

**Customized Cutting to fit unique applications.**



Our fender specialists have the equipment and experience to angle-cut, slot and custom fabricate your new fendering to match your installation requirements.

## Hole Drilling

**Customized Hole Drilling eliminates on-site installation hassles.**



Without the right tools and equipment, hole drilling in the field can be a difficult task. Save time and effort by letting us custom fabricate your bumper to fit your specific application. We will custom drill the fender to match the exact size of studs and space the holes to match your stud size and spacing. It makes the installation of your new fendering system quick and easy.

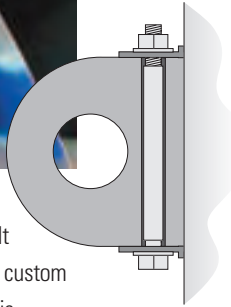

## Custom Extrusions

**Custom Designed Extrusions, any shape, any style, any size.**

When your dock or vessel demands a unique fendering system, Duramax Marine® can custom engineer and manufacture the shape, style, and size your application requires. One of our engineers will work with you closely to help match your specs and design a custom system for your application.

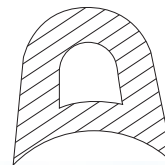
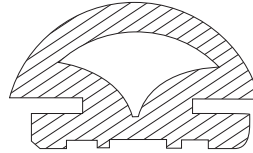
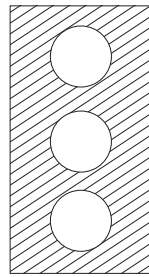

# Duramax® Fender Specialists Available For Design Assistance

## TYPICAL FENDER ATTACHMENT

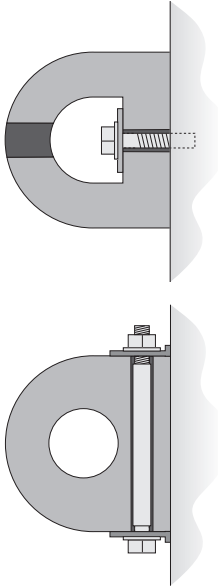

### Selecting the right size and style.

Our fender experts are always available to give you design assistance when you need it. We will recommend the correct geometry, fender cross section and size for your specific application.

### Custom fabricating for easy installation.

With our custom fabrication we can eliminate on-site installation problems. We can angle-cut, slot and custom fabricate the fender to fit your requirements. Our fender experts will work with your specs to custom drill holes to match stud size and spacing.

### Recommended bolt spacing and type of attachment.

Bolt size and spacing are determined by the size of fender, fender usage and mounting arrangements.

**Contact Duramax Marine for specific recommendations regarding your application.**

# Fenders That Stand Tough In Tough Marine Environments

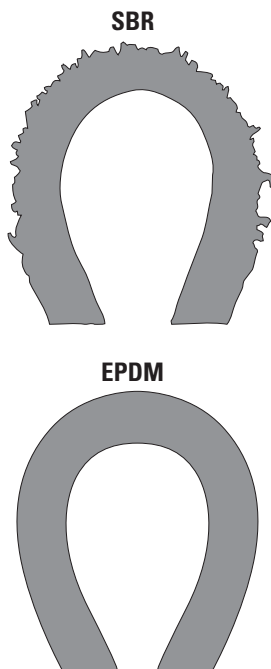

SBR deteriorates rapidly in natural marine environments. Duramax® EPDM outlasts SBR by substantial margin.

### Duramax® EPDM Impact Protection Systems are ozone resistant.

A Duramax® system can last 4x longer than SBR or butyl fenders. Ozone can cause cracking in these lower cost compounds particularly under stress. EPDM resists sunlight, oxidation, seawater and many chemicals.

## HEAT AGING CHARACTERISTICS

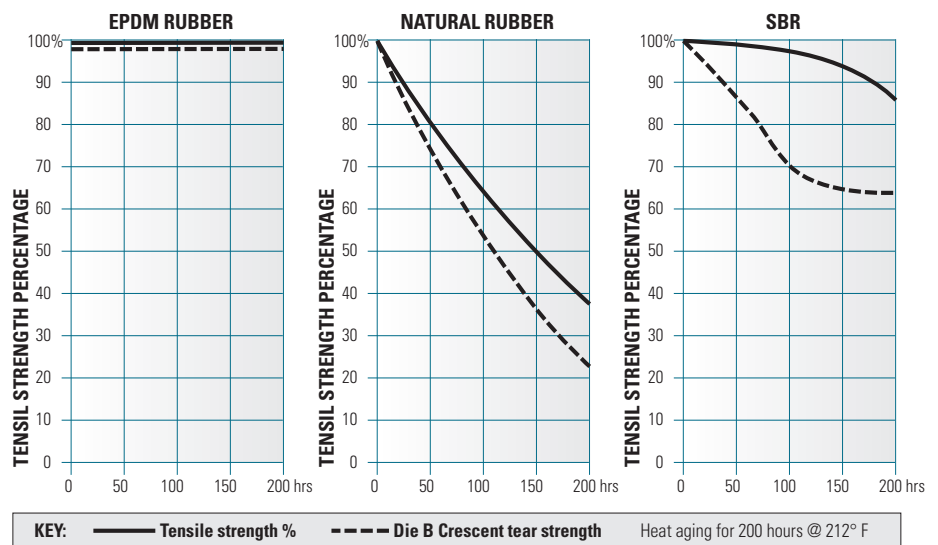



# 100 SERIES

## TAPERED D-SHAPE / KEY BORE

The Duramax® Tapered D-shaped, Key-bore is designed for marine and industrial applications. Provides protection for small vessels, docks, loading docks, trucks and other equipment. Offered in three EPDM colors: black, non-marking grey, and white. Also see our 90 degree molded corner guard/end caps and poly washer strips.

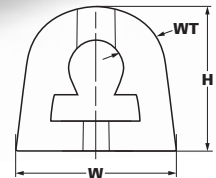
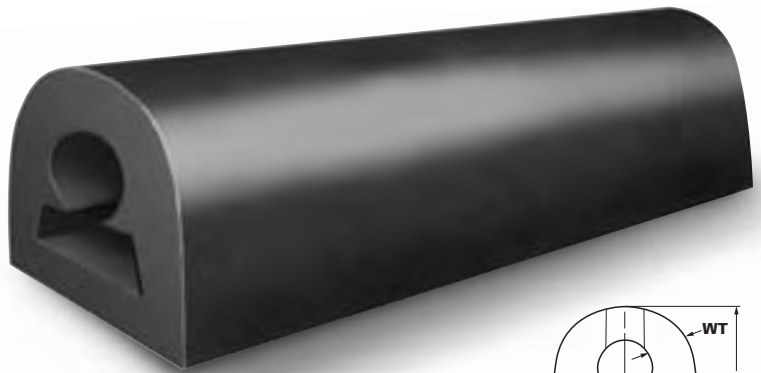

CODE NO.	DURAMAX® PART NO.	BASE WIDTH (W)	HEIGHT (H)	WALL THICKNESS (WT)	WT./FT.	LENGTH UP TO
DB-50	802005001	2 1/8"	2"	7/16"	1.2 LBS.	60 FT.
DB-75	802007501	3 1/8"	2 7/8"	11/16"	2.6 LBS.	60 FT.
DB-100	802009001	4 1/4"	3 7/8"	3/4"	5.1 LBS.	60 FT.

Reaction load, deflection and energy absorption data can be found on next page.

## 100 Series Poly Washer Strip

Supplied in 10-foot sections, our tough polycarbonate washer strip slides inside the Key-bore for mounting.

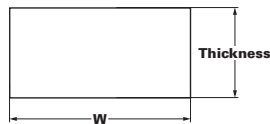

Poly Washer Strip

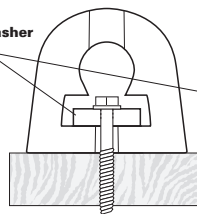

CODE NO.	DURAMAX® PART NO.	WIDTH	THICKNESS	LENGTH
DB-50NS	802000025	1"	3/8"	10 FT.
DB-75NS	802000026	1 1/4"	3/8"	10 FT.
DB-100NS	802000027	1 3/4"	3/8"	10 FT.

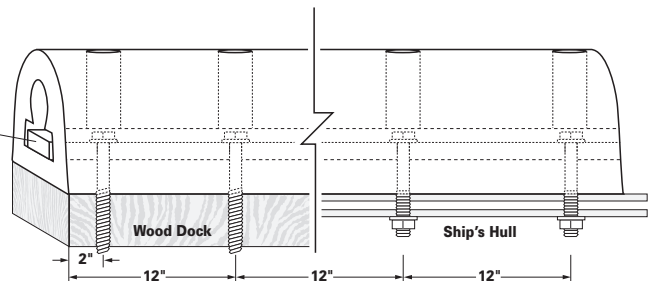

## 90° Molded Insert Corners / End Caps

Insert the legs of these molded EPDM corners into the bore of the DB 50, 75 and 100 for a 90 degree corner. Or one side of the insert may be cut off and used to mount flush to vessel or structure and cap off the end of the extrusion. Stocked in black, grey and white.

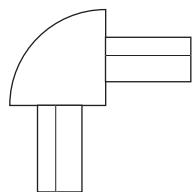

	CODE NO.	DURAMAX® PART NO.	COLOR
DB-50	DB-51	802005101	BLACK
	DB-52	802005202	GREY
	DB-53	802005303	WHITE
DB-75	DB-76	802007601	BLACK
	DB-77	802007702	GREY
	DB-78	802007803	WHITE
DB-100	DB-103	802009301	BLACK
	DB-104	802009402	GREY
	DB-105	802009503	WHITE

# 100 SERIES (CONTINUED)

## TAPERED D-SHAPE / D-BORE

Tapered D-shape offers a slightly different look than the Key-bore cross sections. Also used in marine and industrial applications. Offered in three EPDM colors: black, non-marking grey and white.

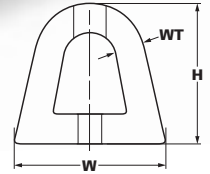

CODE NO.	DURAMAX® PART NO.	BASE WIDTH (W)	HEIGHT (H)	WALL THICKNESS (WT)	WT./FT.	LENGTH UP TO
DB-101	802010101	4 1/4"	3 7/8"	3/4"	4.6 LBS.	60 FT.
DB-115	802011501	4 1/2"	3 3/4"	3/4"	4.7 LBS.	60 FT.
DB-125	802012501	6 3/4"	6"	1 1/2"	13.6 LBS.	20 FT.
DB-150	802015001	9 1/2"	8"	1 1/2"	19.5 LBS.	20 FT.

Pictures here may not accurately depict the amount of taper found in this cross section. Contact Duramax Marine® for drawing.

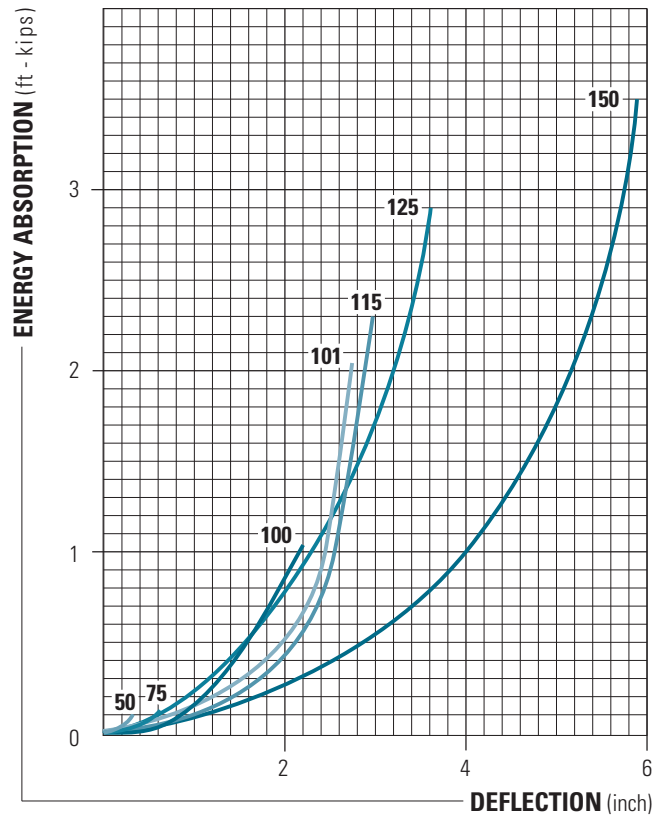
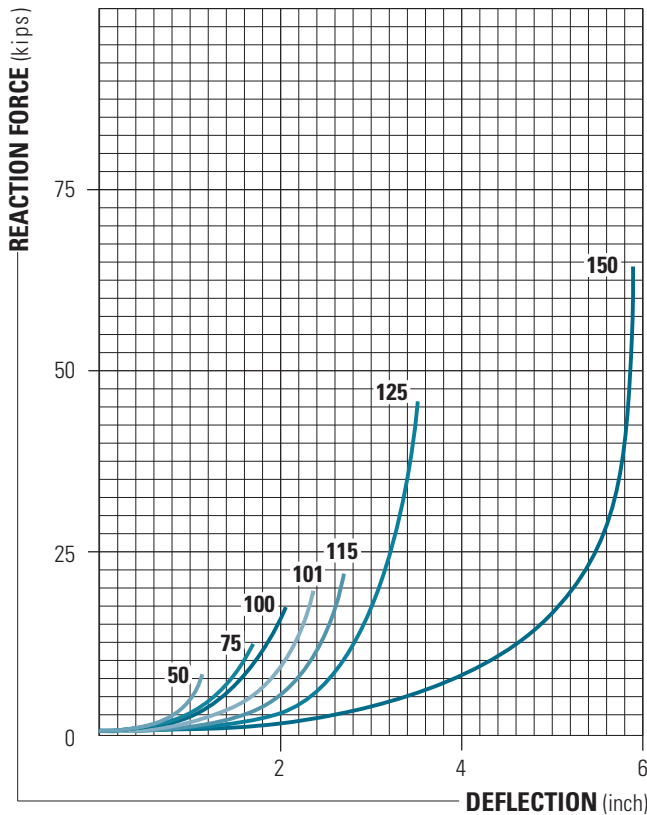



# 200 SERIES

## CYLINDRICAL / O-BORE

Cylindrical fenders are typically hung by running chain through the bore. These durable fenders come in various diameters to meet many different applications and conditions. Offered in three EPDM colors: black, non-marking grey and white.

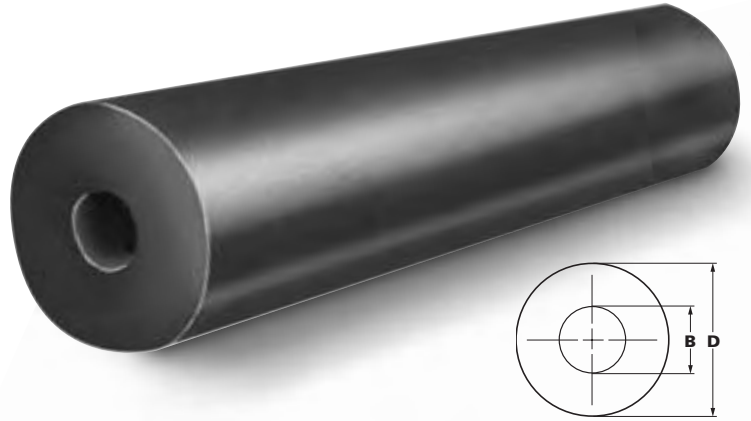

CYLINDRICAL/O-BORE

CODE NO.	DURAMAX® PART NO.	OUTSIDE DIAMETER (D)	BORE (B)	WT./FT.	LENGTH UP TO
DB-202	802020201	3"	1"	3.2 LBS.	60 FT.
DB-203	802020301	3"	1 1/2"	2.7 LBS.	60 FT.
DB-205	802020501	5"	2 1/2"	8 LBS.	30 FT.
DB-206	802020601	7"	3"	16 LBS.	20 FT.
DB-207	802020701	7"	3 1/2"	15.5 LBS.	20 FT.
DB-208	802020801	8"	4"	19.8 LBS.	20 FT.
DB-210	802021001	10"	5"	32 LBS.	20 FT.
DB-212	802021201	12"	6"	46 LBS.	20 FT.
DB-215	802021501	15"	7 1/2"	69.5 LBS.	20 FT.
DB-218	802021801	18"	9"	100 LBS.	20 FT.

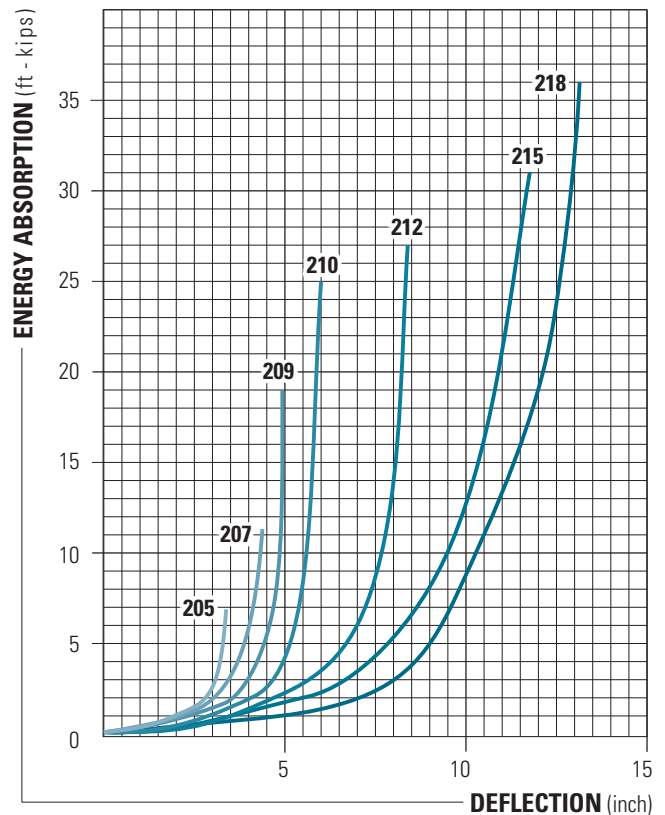
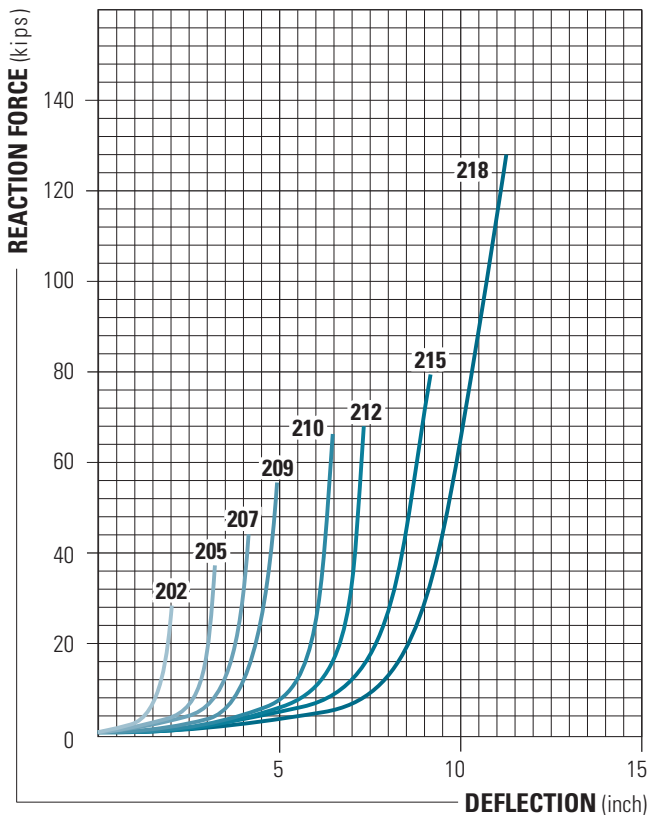

# 300 SERIES

## RECTANGULAR / O-BORE

Mounted vertically or horizontally to provide good protection to docks and vessels. Typical mounting is in a channel with through hole across the base of fender. Offered in three EPDM colors: black, non-marking grey and white.

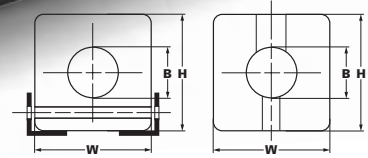
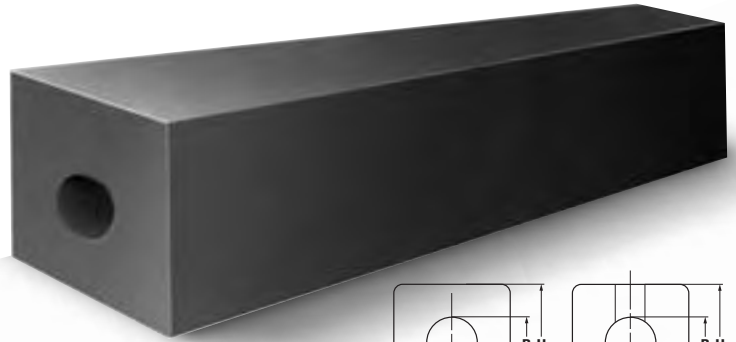

RECTANGULAR/O-BORE

CODE NO.	DURAMAX® PART NO.	HEIGHT (H)	WIDTH (W)	BORE (B)	WT./FT.	LENGTH UP TO
DB-302	802030201	2"	4"	SOLID	3.9 LBS.	60 FT.
DB-303	802030301	3 1/2"	4 1/2"	1"	8 LBS.	60 FT.
DB-304	802030401	5"	5"	2 1/2"	9.8 LBS.	60 FT.
DB-305	802030501	5"	6 1/2"	2 1/2"	13 LBS.	40 FT.
DB-305A	802030511	5 1/2"	6"	2 1/2"	13.9 LBS.	40 FT.
DB-306	802030601	6"	6 1/2"	2 1/2"	17.4 LBS.	20 FT.
DB-306A	802030611	6"	6"	2 7/8"	14.6 LBS.	20 FT.
DB-306B	802030621	6"	7"	2 1/2"	18 LBS.	20 FT.
DB-307	802030701	7"	10"	3"	34.1 LBS.	20 FT.
DB-307A	802030711	7"	10"	3 1/2"	30 LBS.	20 FT.
DB-308	802030801	8"	8"	3"	28.2 LBS.	20 FT.
DB-309	802030901	8"	10"	3"	39.5 LBS.	20 FT.
DB-309A	802030911	9"	10"	SOLID	50.7 LBS.	20 FT.
DB-310	802031001	10"	10"	4"	42.4 LBS.	20 FT.
DB-311	802031101	10"	12"	4"	60 LBS.	20 FT.
DB-312	802031201	12"	12"	5"	65 LBS.	20 FT.
DB-313	802031301	12"	12"	4"	68.5 LBS.	20 FT.
DB-314	802031401	14"	14"	6"	83 LBS.	20 FT.

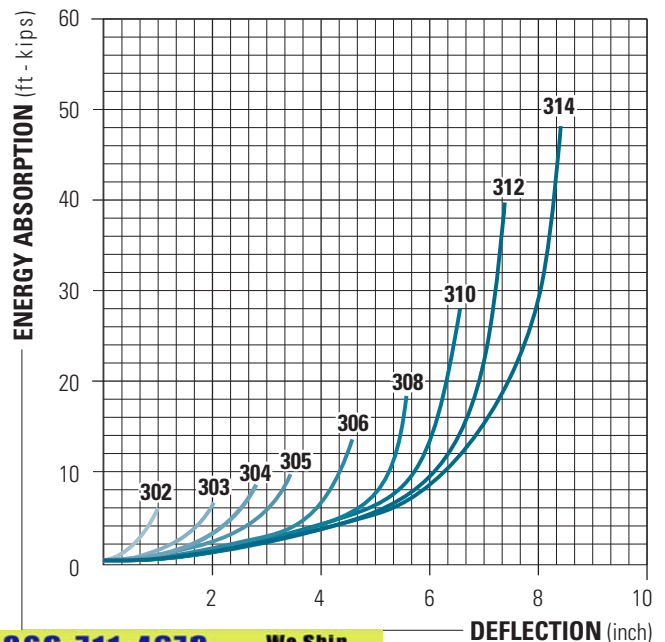
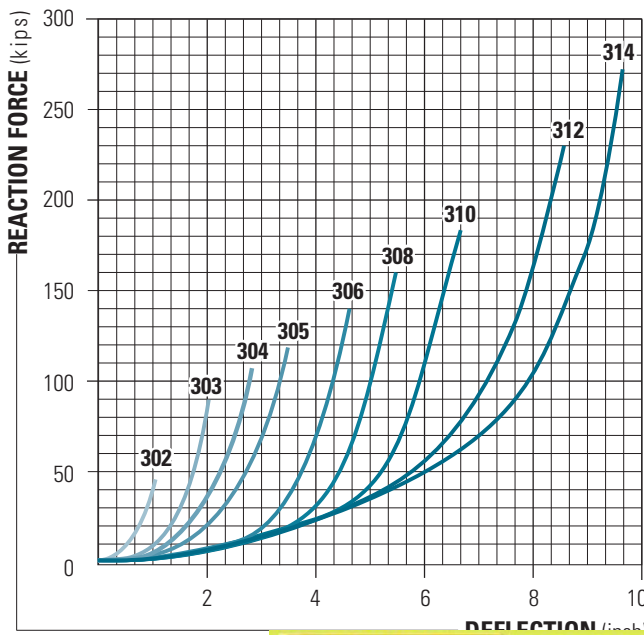



# 400 SERIES

## WING TYPE O-BORE

Designed for easy attachment to vessels and docks.

Drill and bolt fender to structure using the integral wings.

Eliminates need for mounting holes on the facing. Offered in three EPDM colors: black, non-marking grey and white.

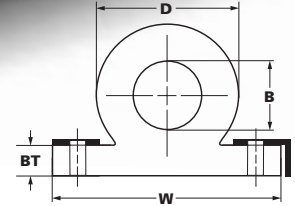
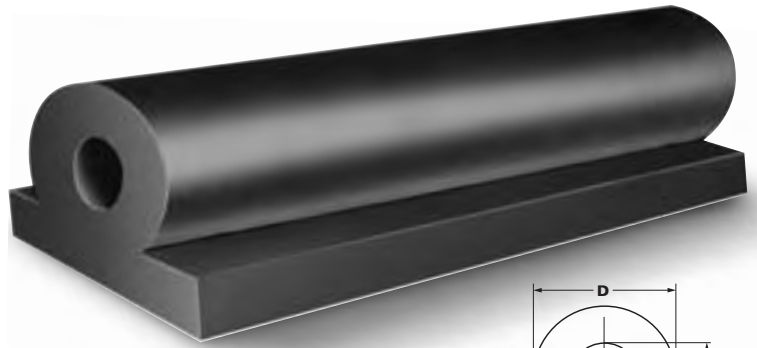

CODE NO.	DURAMAX® PART NO.	BASE WIDTH (W)	BASE THICKNESS (BT)	OUTSIDE DIAM. (D)	BORE DIAM.	WT./FT.	LENGTH UP TO
DB-404	802040401	4"	1/2"	2 1/2"	1"	3.5 LBS.	60 FT.
DB-405	802040501	5"	1/2"	2 1/2"	1"	4 LBS.	60 FT.
DB-406	802040601	6"	3/4"	3"	1"	5.3 LBS.	60 FT.
DB-407	802040701	6 1/2"	1"	4"	2"	7 LBS.	60 FT.
DB-408	802040801	6 1/2"	1"	4"	1"	8.9 LBS.	60 FT.
DB-409	802040901	9"	1 1/2"	6"	3"	15.3 LBS.	20 FT.
DB-409A	802040911	9"	1 1/2"	6"	2"	17.4 LBS.	20 FT.
DB-410	802041001	9 1/2"	1 1/2"	6"	2"	17.7 LBS.	20 FT.
DB-412	802041201	12"	2"	8"	4"	27 LBS.	20 FT.
DB-416	802041601	16"	2 1/2"	10"	4"	47.5 LBS.	20 FT.
DB-418	802041801	18"	3"	12"	6"	61 LBS.	20 FT.

WING TYPE O-BORE

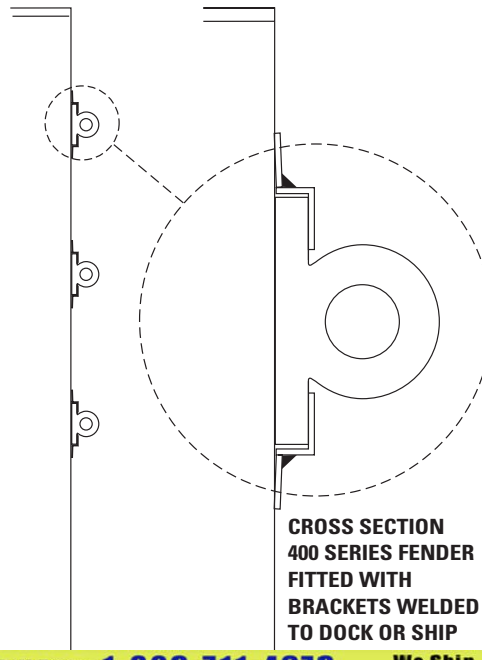
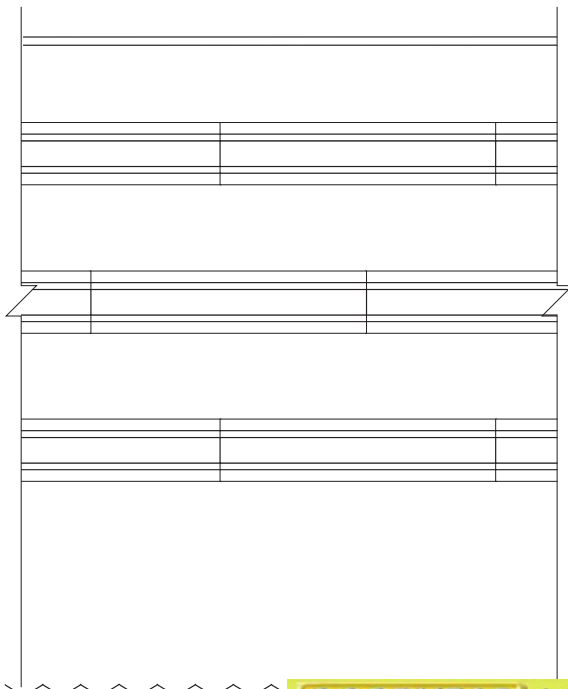

**CROSS SECTION  
400 SERIES FENDER  
FITTED WITH  
BRACKETS WELDED  
TO DOCK OR SHIP**

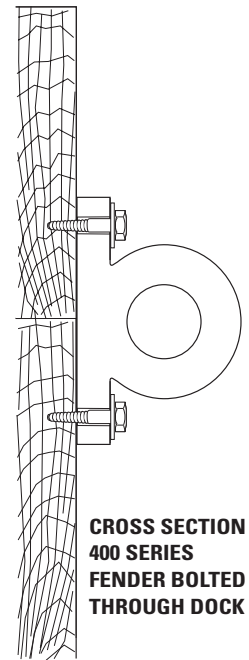

**CROSS SECTION  
400 SERIES  
FENDER BOLTED  
THROUGH DOCK**

# 400 SERIES (CONTINUED)

## WING TYPE SOLID

Manufactured in black, non-marking grey and white EPDM

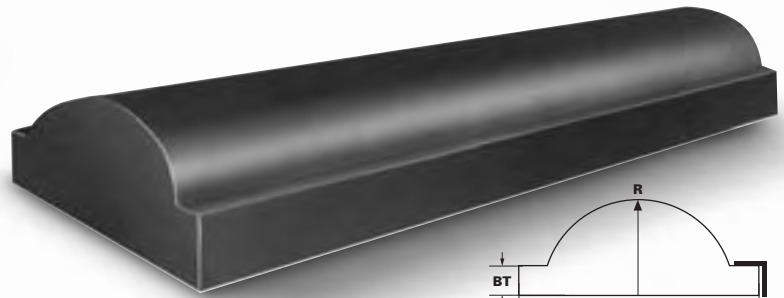

CODE NO.	DURAMAX® PART NO.	BASE WIDTH (W)	BASE THICKNESS (BT)	RADIUS (R)	WT./FT.	LENGTH UP TO
DB-460	802046001	10"	1 1/4"	4"	14.6	20 FT.

WING TYPE SOLID/D-BORE

## WING TYPE D-BORE

Manufactured in black, non-marking grey and white EPDM

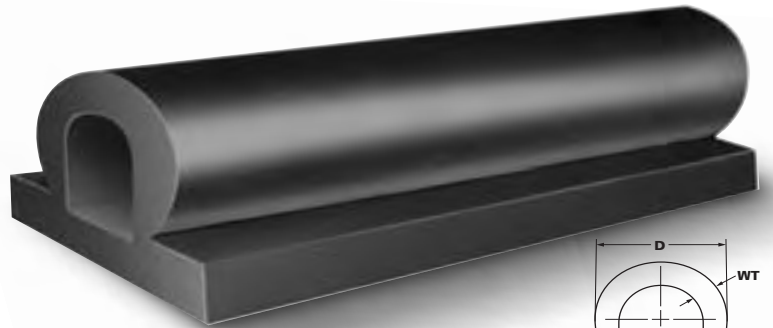

CODE NO.	DURAMAX® PART NO.	BASE WIDTH (W)	BASE THICKNESS (BT)	OUTSIDE DIAM. (D)	WALL THICKNESS (WT.)	WT./FT.	LENGTH UP TO
DB-440	802044001	9 1/2"	1 1/4"	6"	1"	14.9 LBS.	20 FT.

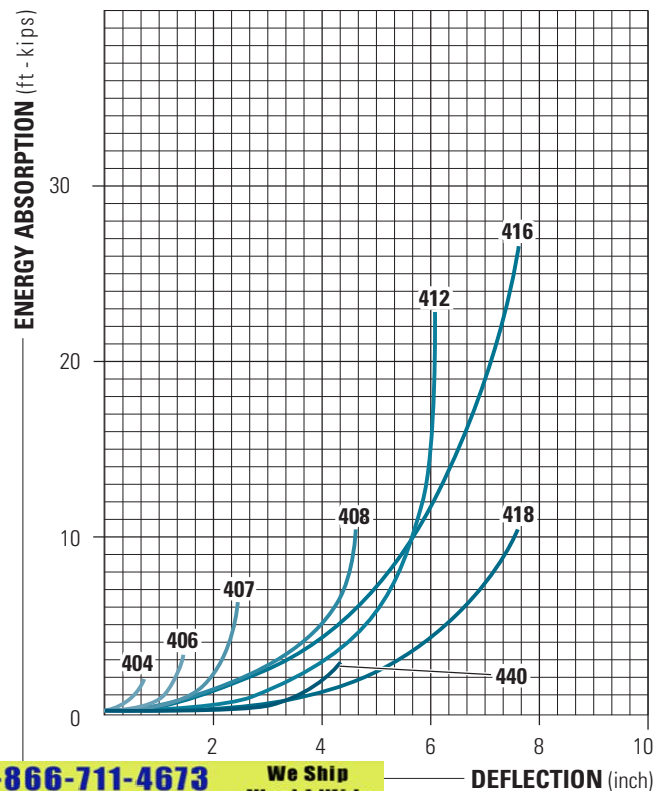
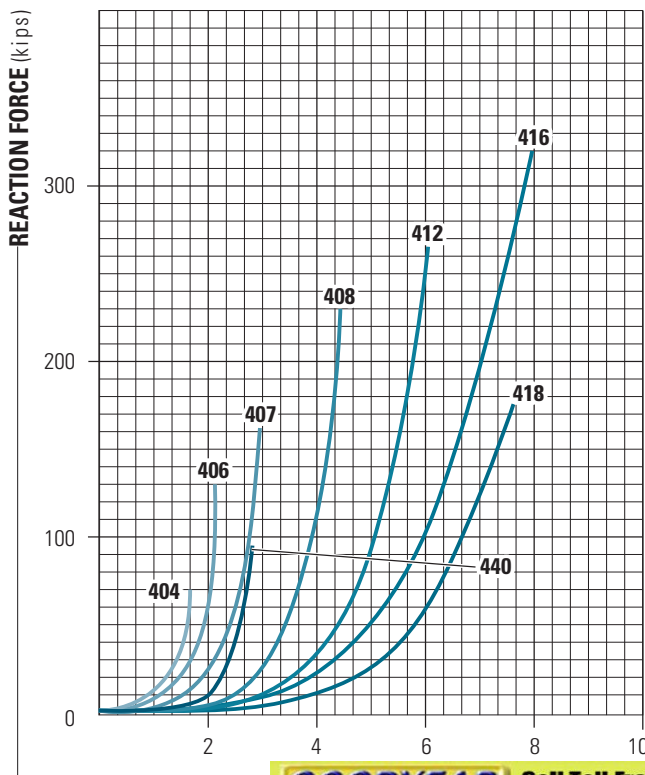



# 500 SERIES

## FAN NOSE

For a professional looking D-shaped installation try our fan nose bumper. Held on the vessel, truck or dock in an angle iron channel, no mounting holes are necessary.

Offered in three EPDM colors: black, non-marking grey and white.

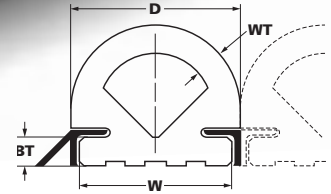
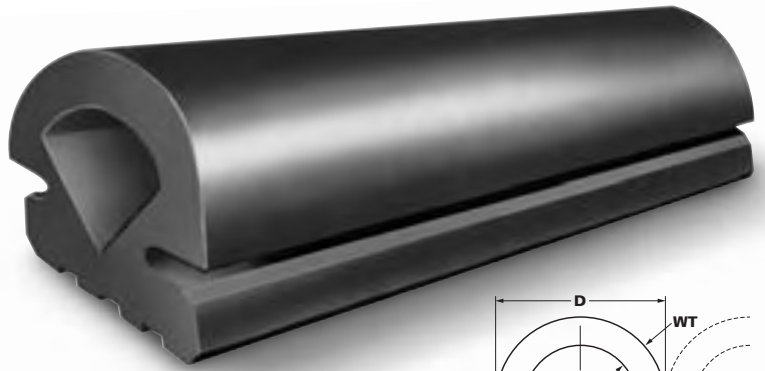

CODE NO.	DURAMAX® PART NO.	BASE WIDTH (W)	BASE THICKNESS (BT)	OUTSIDE DIAM. (D)	WALL THICKNESS WT.	WT./FT.	LENGTH UP TO
DB-503	802050301	2 1/2"	17/32"	3"	5/8"	2.5 LBS.	60 FT.
DB-504	802050401	3 3/4"	25/32"	4 1/4"	3/4"	4.7 LBS.	60 FT.
DB-506	802050601	5 7/16"	1"	6"	1"	9.0 LBS.	20 FT.
DB-508	802050801	7 1/4"	1 3/16"	8"	1 1/2"	15.5 LBS.	20 FT.
DB-510	802051001	9 1/4"	1 11/16"	10"	1 1/2"	24.8 LBS.	20 FT.
DB-512	802051201	11"	2"	12"	2"	28.6 LBS.	20 FT.

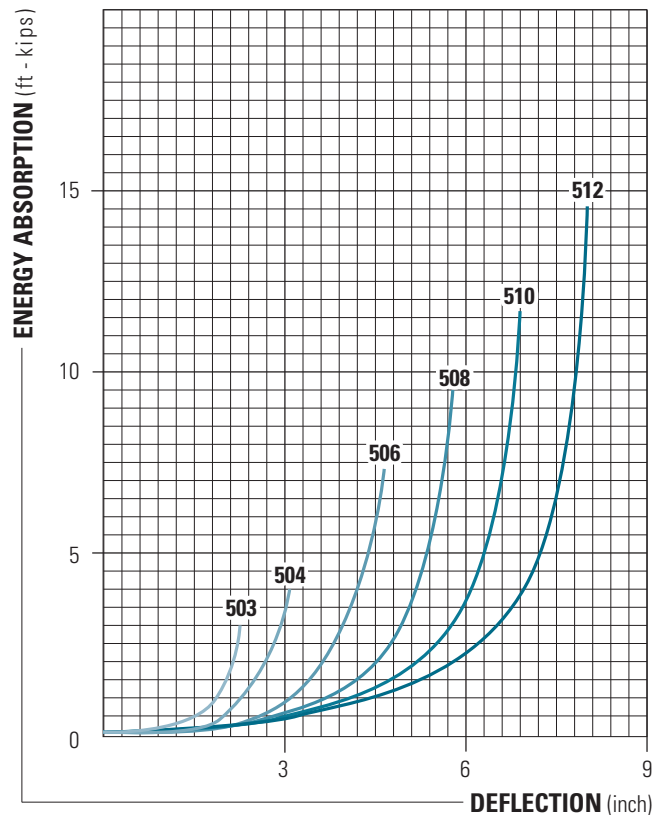
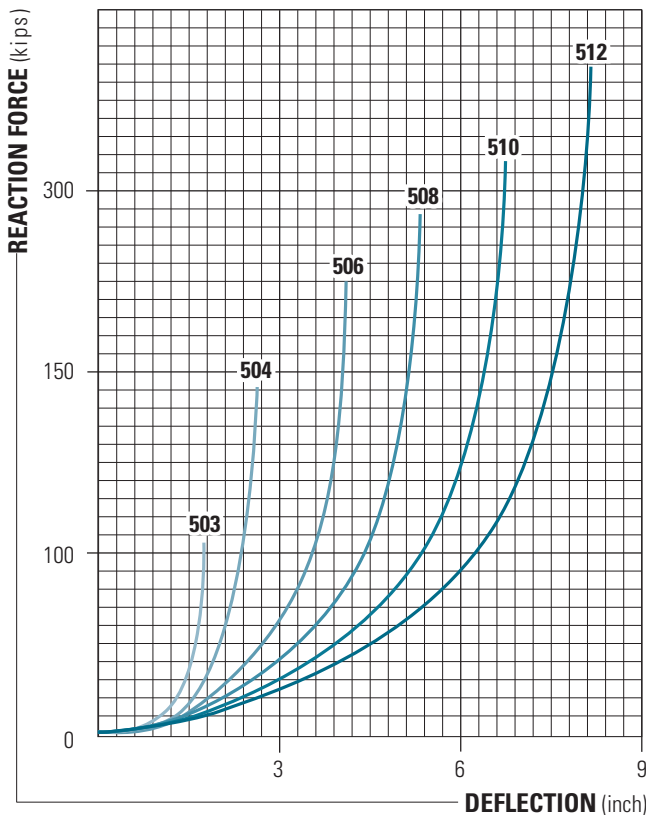

# 600 SERIES

## RECTANGULAR CHAIN

Unique Duramax® rectangular solid bumper is extruded with a continuous chain throughout the length of the piece.

Standard leaders on ends are 6 inches long, but longer lengths are available upon request.



CODE NO.	DURAMAX® PART NO.	BASE WIDTH (W)	HEIGHT (H)	CHAIN SIZE	WT./FT.	PROOF COIL CHAIN LOAD LIMIT	ALLOY CHAIN LOAD LIMIT
DB-604	802060401	5"	5"	1/2"	14 LBS.	4250 LBS.	11250 LBS.
DB-605	802060501	6 1/2"	5"	1/2"	18 LBS.	4250 LBS.	11250 LBS.
DB-606	802060601	6 1/2"	6"	1/2"	22 LBS.	4250 LBS.	11250 LBS.
DB-608	802060801	8"	8"	1/2"	36 LBS.	4250 LBS.	11250 LBS.
DB-609	802060901	10"	8"	5/8"	46 LBS.	6375 LBS.	16500 LBS.
DB-610	802061001	10"	10"	5/8"	65 LBS.	6375 LBS.	16500 LBS.
DB-612	802061201	12"	12"	5/8"	85 LBS.	6375 LBS.	16500 LBS.
DB-614	802061401	14"	14"	5/8"	110 LBS.	6375 LBS.	16500 LBS.

EXTRUSION W/CHAIN

# 700 SERIES

## CYLINDRICAL CHAIN

Unique Duramax® cylindrical solid bumper is extruded with a continuous chain throughout the length of the piece.

Standard leaders on ends are 6 inches long, but longer lengths are available upon request.

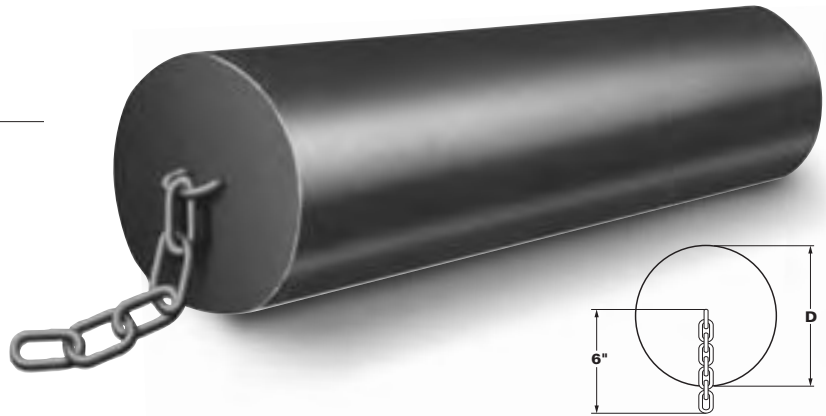

CODE NO.	DURAMAX® PART NO.	OUTSIDE DIAM. (D)	CHAIN SIZE	APPROX. WT./FT.	PROOF COIL CHAIN LOAD LIMIT	ALLOY CHAIN LOAD LIMIT
DB-705	802070501	5"	1/2"	12 LBS.	4250 LBS.	11250 LBS.
DB-706	802070601	6"	1/2"	16 LBS.	4250 LBS.	11250 LBS.
DB-707	802070701	7"	1/2"	23 LBS.	4250 LBS.	11250 LBS.
DB-708	802070801	8"	5/8"	30 LBS.	6375 LBS.	16500 LBS.
DB-709	802070901	9"	5/8"	37 LBS.	6375 LBS.	16500 LBS.
DB-710	802071001	10"	3/4"	47 LBS.	9125 LBS.	23000 LBS.
DB-711	802071101	11"	3/4"	55 LBS.	9125 LBS.	23000 LBS.
DB-712	802071201	12"	1"	68 LBS.	12400 LBS.	38750 LBS.



# 600 & 700 SERIES Configurations

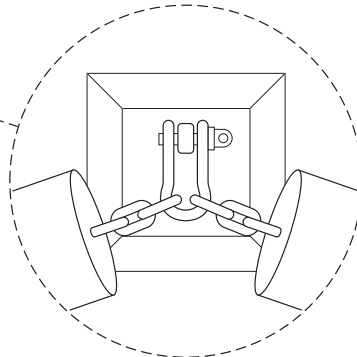
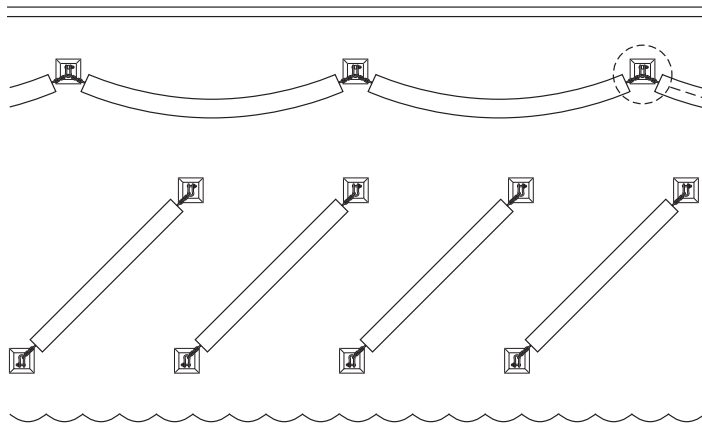

**DETAIL OF "EYEBOLT" & FENDER WITH EMBEDDED CHAIN**

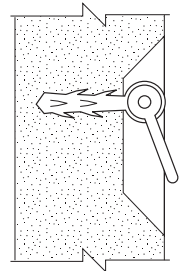

**CROSS SECTION OF RECESSED "EYEBOLT" EMBEDDED IN CONCRETE**

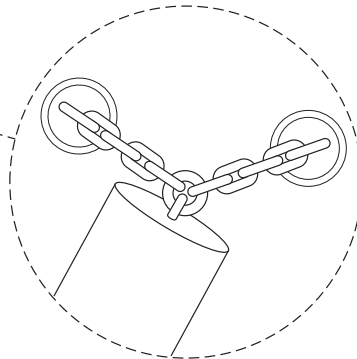
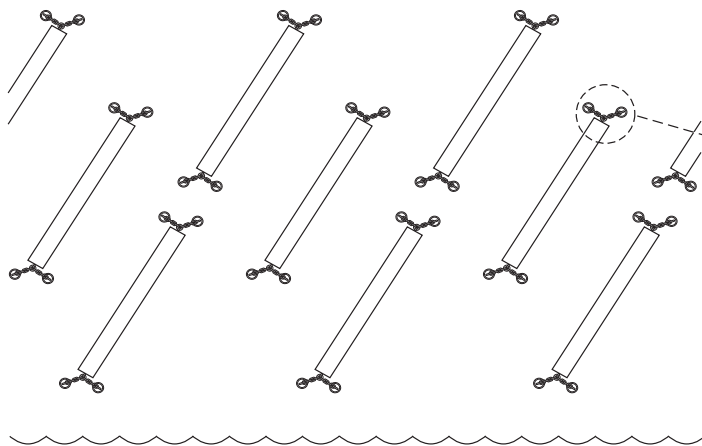

**DETAIL OF "EYE RING" & FENDER WITH EMBEDDED CHAIN**

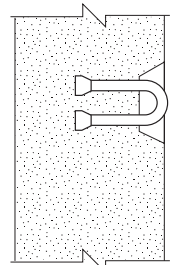

**CROSS SECTION OF RECESSED "EYE RING" EMBEDDED IN CONCRETE**

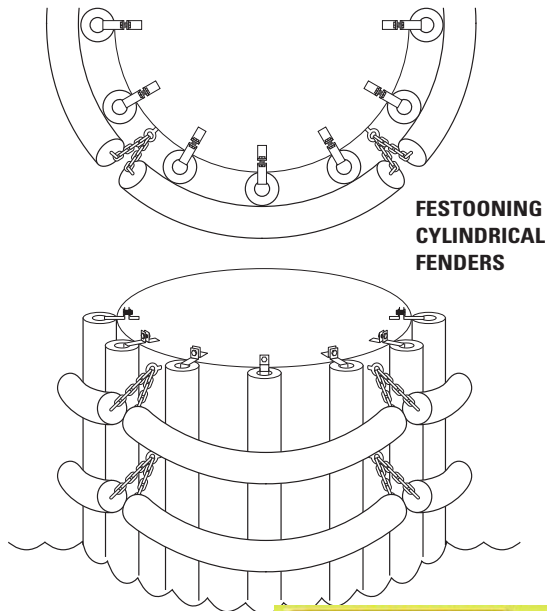

**FESTOONING CYLINDRICAL FENDERS**

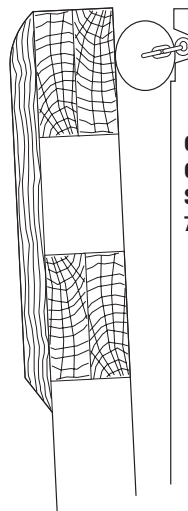

**CROSS SECTION OF DOCK FRONTAL SYSTEM WITH 700 SERIES FENDER**

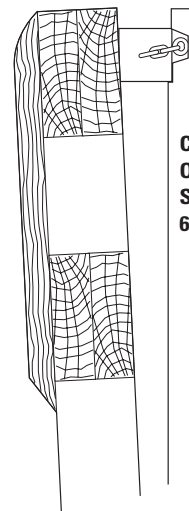

**CROSS SECTION OF DOCK FRONTAL SYSTEM WITH 600 SERIES FENDER**

EXTRUSION W/CHAIN

# 800 SERIES

## CORNER GUARD

The Duramax® Corner Guard fender is designed to give optimal protection to 90 degree corners.

Extrusion has 2" wings for easy fastening.

Offered in three EPDM colors: black, non-marking grey and white.

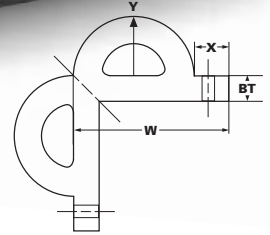
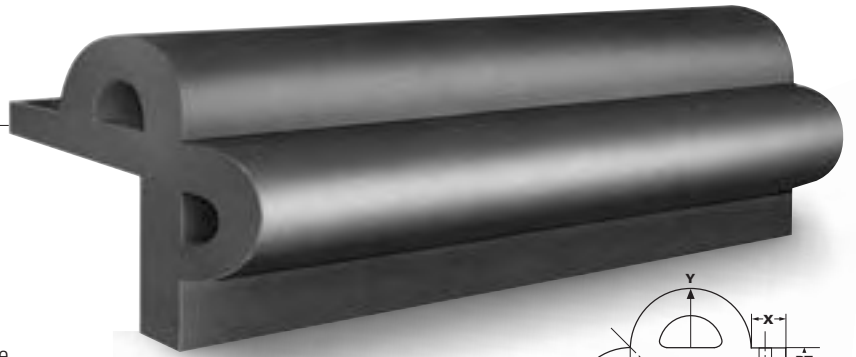

CODE NO.	DURAMAX® PART NO.	BASE WIDTH (W)	BASE THICKNESS (BT)	WING LENGTH (X)	OUTSIDE DIAM. (Y)	WT./FT.	LENGTH UP TO
DB-809	802080901	5 9/16"	1 1/2"	2"	3"	21 LBS.	10 FT.

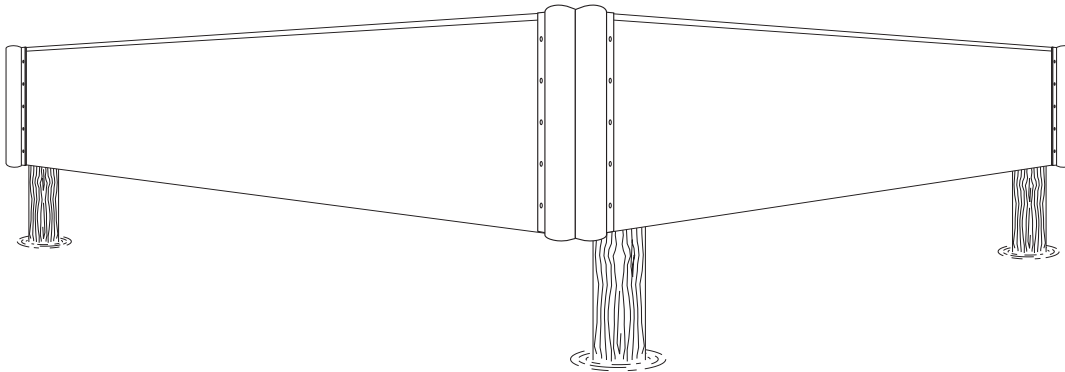

CORNER GUARD

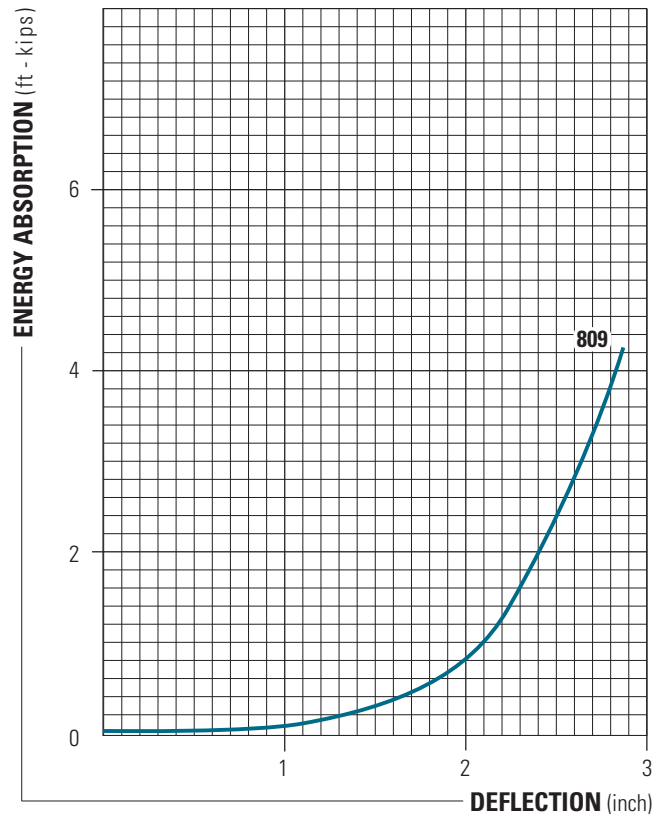
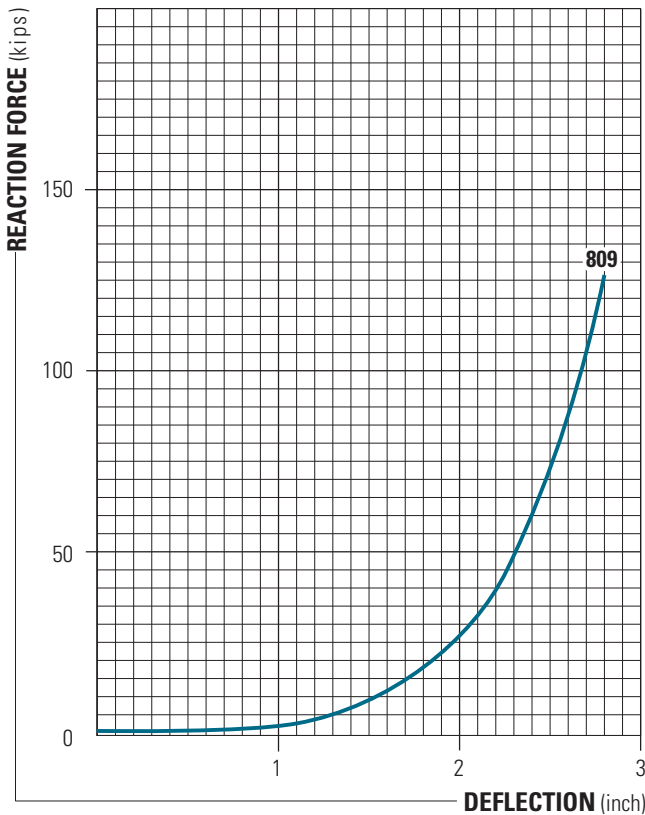

# 900 SERIES

## D-SHAPED / O-BORE

Great all purpose, rugged D-shaped fenders mount by drilling a through hole across the base. Offered in three EPDM colors: black, non-marking grey and white.

See page 26 for D-shaped / D-bore fenders.

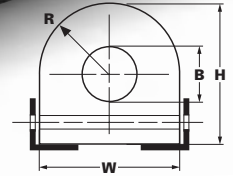
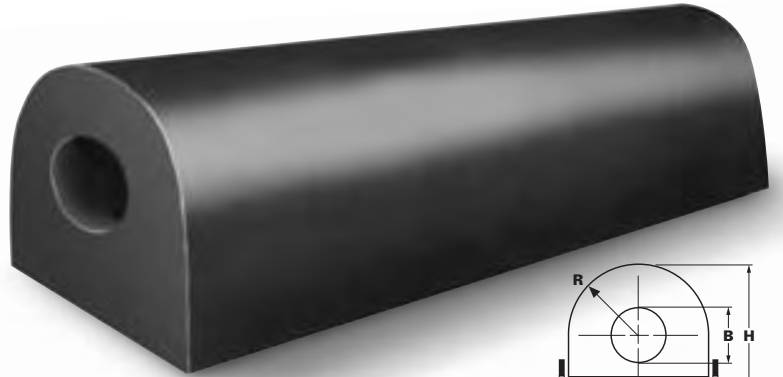

CODE NO.	DURAMAX® PART NO.	BASE WIDTH (W)	BASE HEIGHT (H)	BORE (B)	RADIUS (R)	WT./FT.	LENGTH UP TO
DB-906	802090601	5"	6"	2 1/2"	2 1/2"	11.7 LBS.	20 FT.
DB-906A	802090611	6"	6"	3"	3"	13 LBS.	20 FT.
DB-908	802090801	8"	8"	3"	4"	26.2 LBS.	20 FT.
DB-909	802090901	8"	10"	3"	4"	34 LBS.	20 FT.
DB-909B	802090911	9 1/4"	10"	3"	5"	40 LBS.	20 FT.
DB-910	802091001	10"	10"	3"	5"	43 LBS.	20 FT.
DB-910A	802091011	10"	10"	4"	5"	41.7 LBS.	20 FT.
DB-912	802091201	12"	12"	4"	6"	66 LBS.	20 FT.
DB-912A	802091211	12"	12"	5"	6"	65 LBS.	20 FT.
DB-912B	802090013	12"	14"	5"	6"	69.6 LBS.	20 FT.
DB-912C	802091231	12"	14"	4"	6"	73.3 LBS.	20 FT.
DB-914	802091401	14"	14"	6"	7"	76.8 LBS.	20 FT.
DB-914B	802091421	14"	12"	6"	7"	60 LBS.	20 FT.
DB-914C	802091431	13.5"	12"	6"	6.75"	60 LBS.	20 FT.

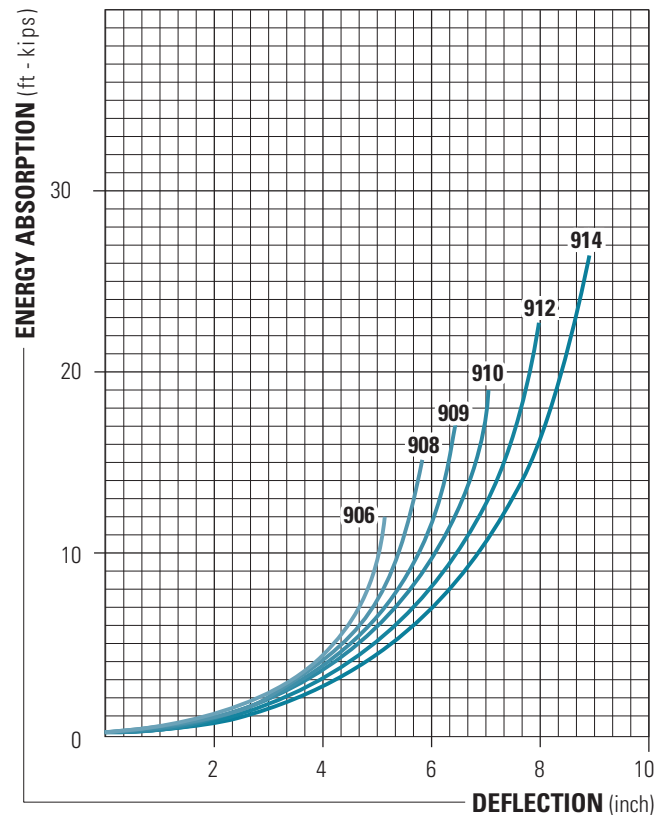
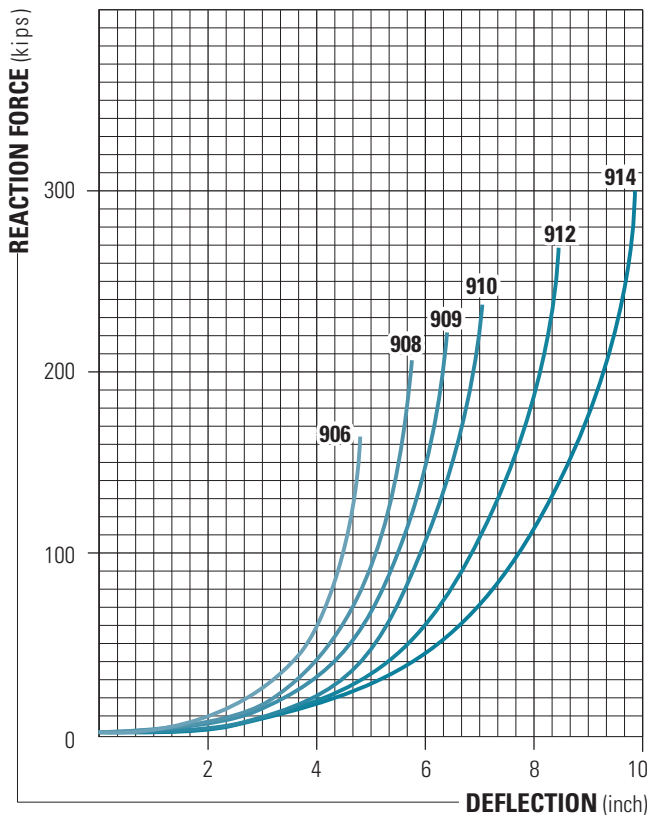



# 900 SERIES *(CONTINUED)*

## D-SHAPED / D-BORE

Square D-shaped, D-bore fenders are designed for general purpose. Mount by drilling an access hole through the top of the D and a base hole through the flat part of the D.

Offered in three EPDM colors: black, non-marking grey and white.

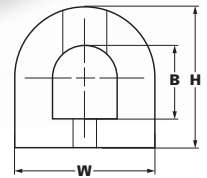

CODE NO.	DURAMAX® PART NO.	BASE WIDTH (W)	HEIGHT (H)	BORE (B)	WT./FT.	LENGTH UP TO
DB-954	802090022	4"	4"	2" x 2"	6 LBS.	20 FT.
DB-956	802090021	6"	6"	3" x 3"	12.5 LBS.	20 FT.
DB-958	802090005	8"	8"	4" x 4"	22.5 LBS.	20 FT.
DB-960	802090011	10"	10"	5" x 5"	35.1 LBS.	20 FT.
DB-962	802090015	12"	12"	6" x 6"	50.5 LBS.	20 FT.
DB-964	802090003	14"	14"	7" x 7"	72 LBS.	20 FT.

D-SHAPE / D-BORE

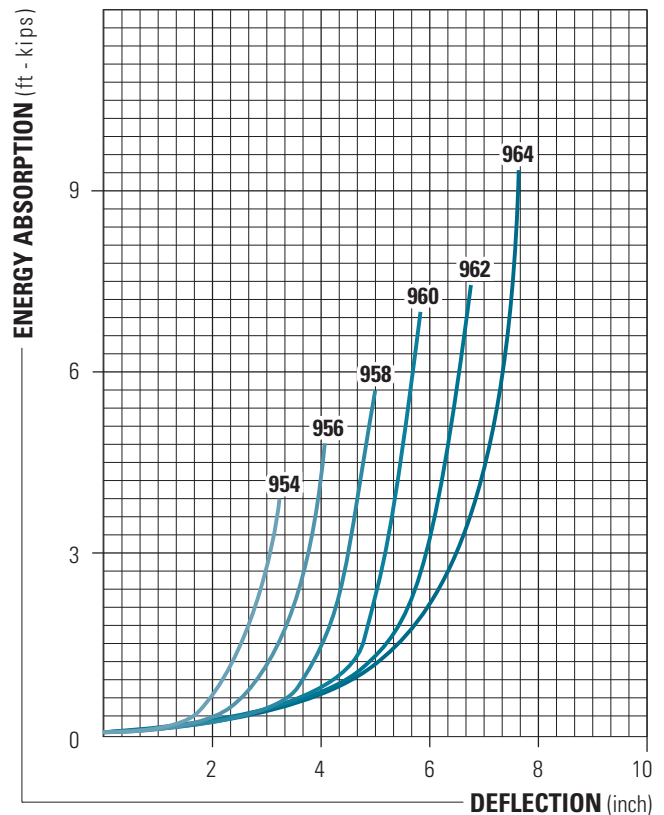
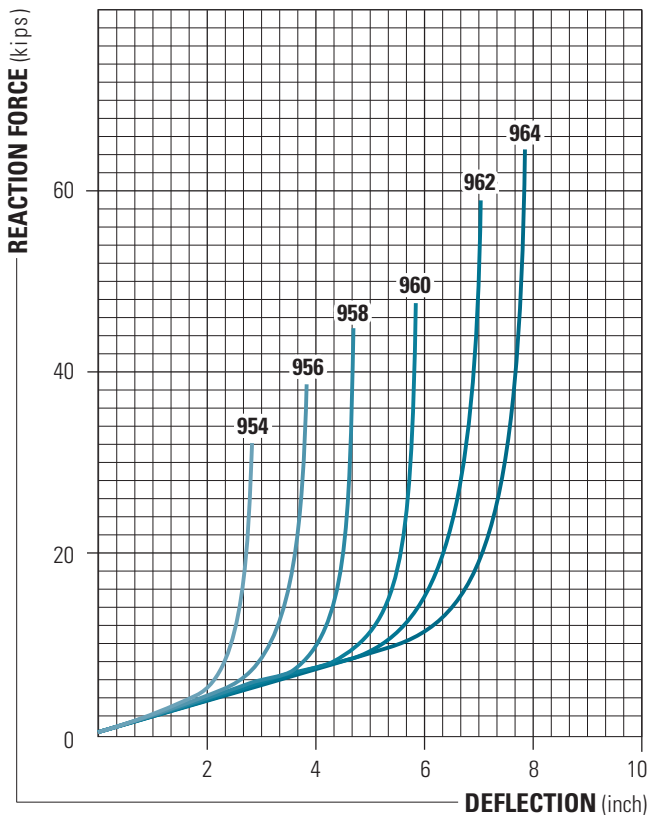

# 1000 SERIES

## FLAT HEAD

For a very professional looking rectangular fender installation try our flat head series! Held on the vessel, truck or dock in an angle iron channel, no mounting holes are necessary.

Manufactured in black EPDM.

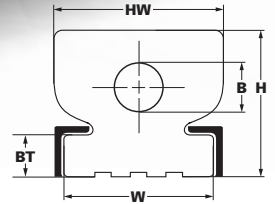
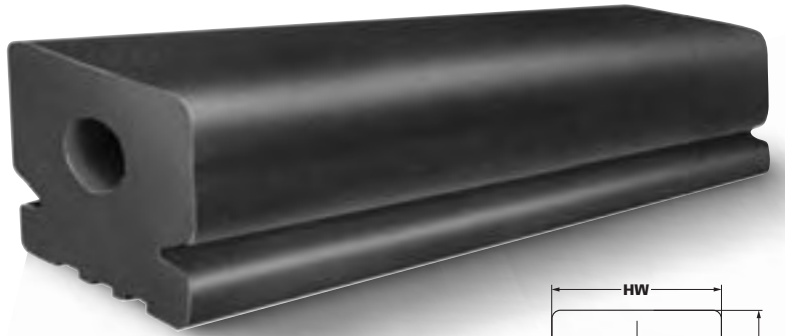

CODE NO.	DURAMAX® PART NO.	BASE WIDTH (W)	BASE THICKNESS (BT)	HEAD WIDTH (HW)	HEIGHT (H)	BORE (B)	WT./FT.	LENGTH UP TO
DB-1006	802100601	6 1/2"	1 11/16"	7 3/8"	6"	1 3/4"	18.6 LBS.	20 FT.
DB-1009	802100901	9"	2 29/32"	9 7/16"	7 1/2"	3"	24 LBS.	20 FT.

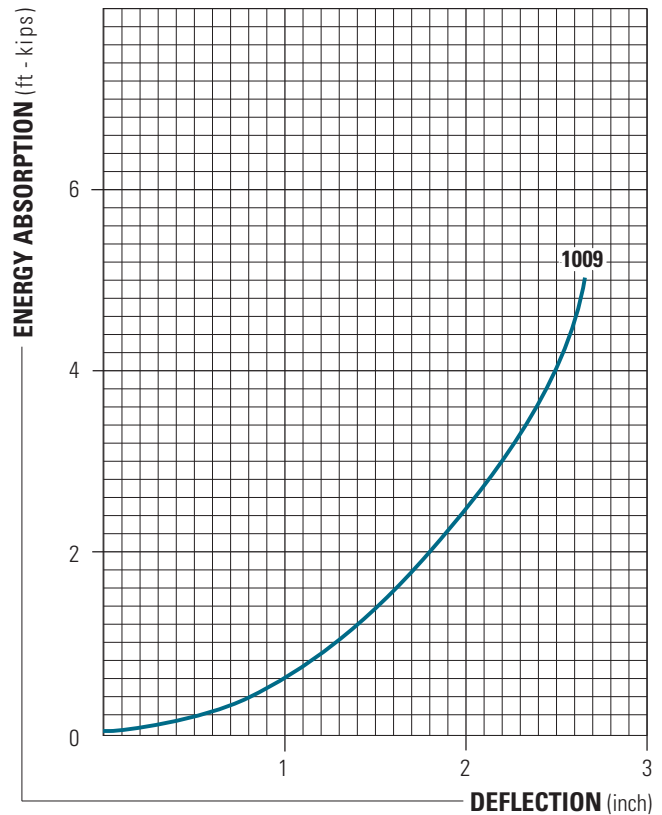
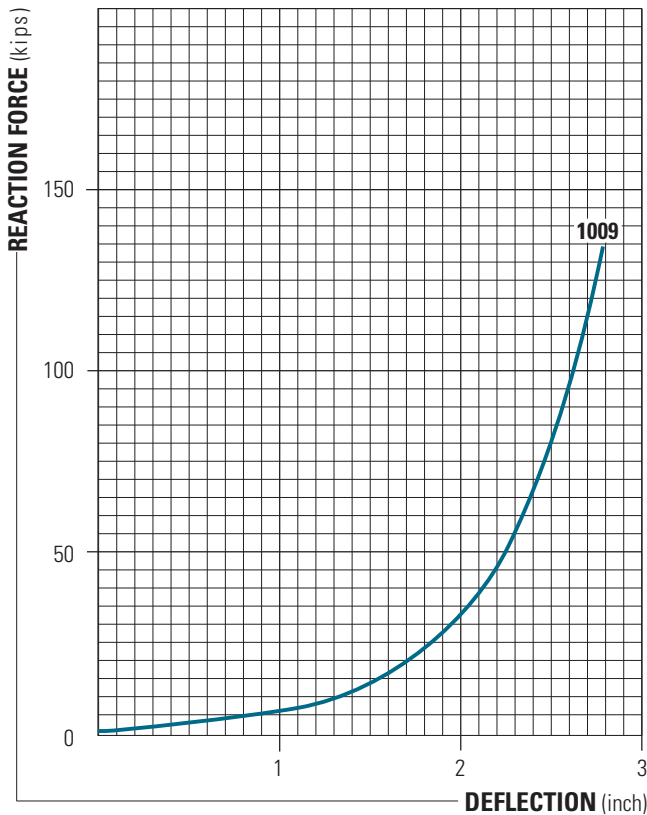

# 1100 SERIES

## CHANNEL LOCK

Yet another unique Duramax® dock bumper design that is produced in black, non-marking grey and white. A popular design, especially in white! Duramax Marine® does not supply channel and flat bar for this cross section but can offer recommendations on a source of supply.

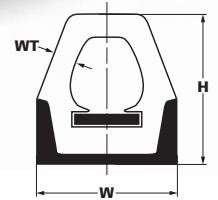
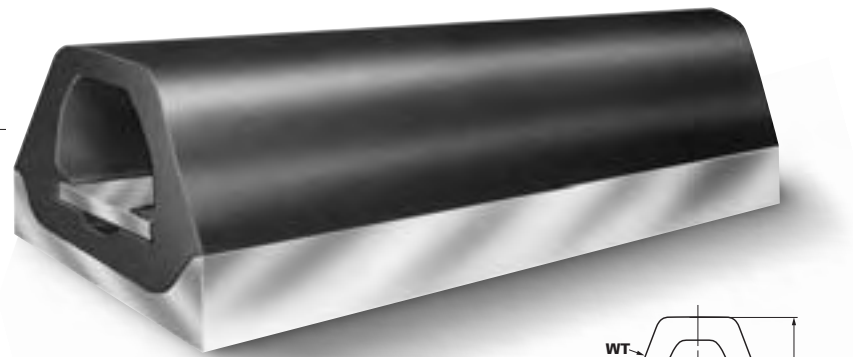

CODE NO.	DURAMAX® PART NO.	BASE WIDTH (W)	WALL THICKNESS (WT)	HEIGHT (H) RUBBER ONLY	WT./FT.	LENGTH UP TO
DB-1103	802110301	3"	1 9/32"	3 1/4"	2.8 LBS.	60 FT.
DB-1104	802110401	4"	3/4"	4 5/16"	4.5 LBS.	40 FT.

CHANNEL LOCK

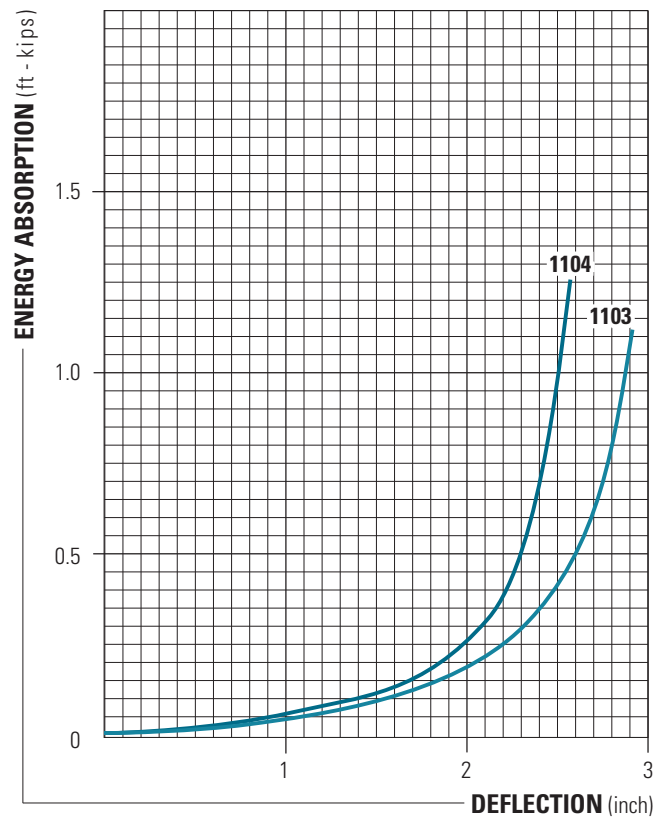
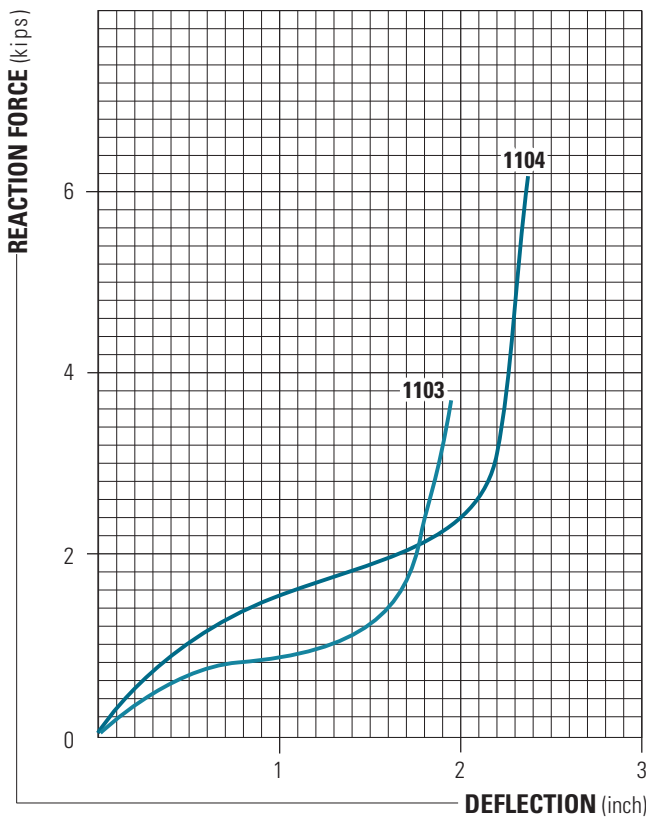

# 2100 SERIES

## TRAPEZOID

The trapezoidal fender is a robust multi-purpose extrusion. Offered in black EPDM only.

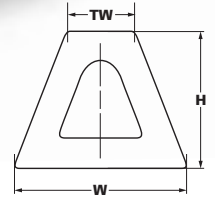
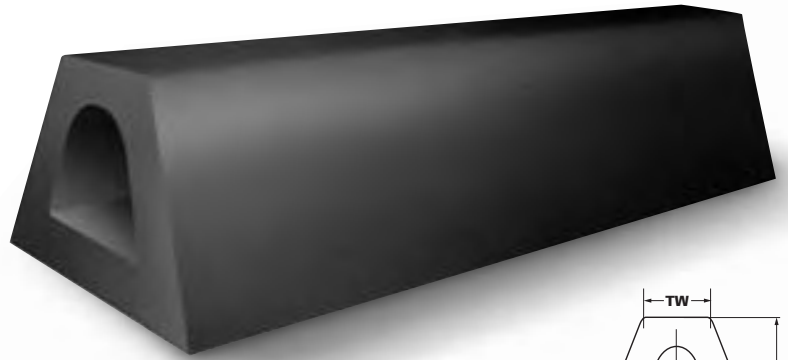

CODE NO.	DURAMAX® PART NO.	HEIGHT (H)	TOP WIDTH (TW)	BASE WIDTH (BW)	WT./FT.	LENGTH UP TO
DB-2110	802211001	10"	5 1/2"	12 3/4"	35	20 FT.
DB-2113	802211301	13"	7 3/8"	16 5/8"	59	20 FT.
DB-2115	802211501	15"	5 5/8"	19 1/8"	77	20 FT.
DB-2117	802211701	17"	9 7/8"	21 5/8"	100	20 FT.

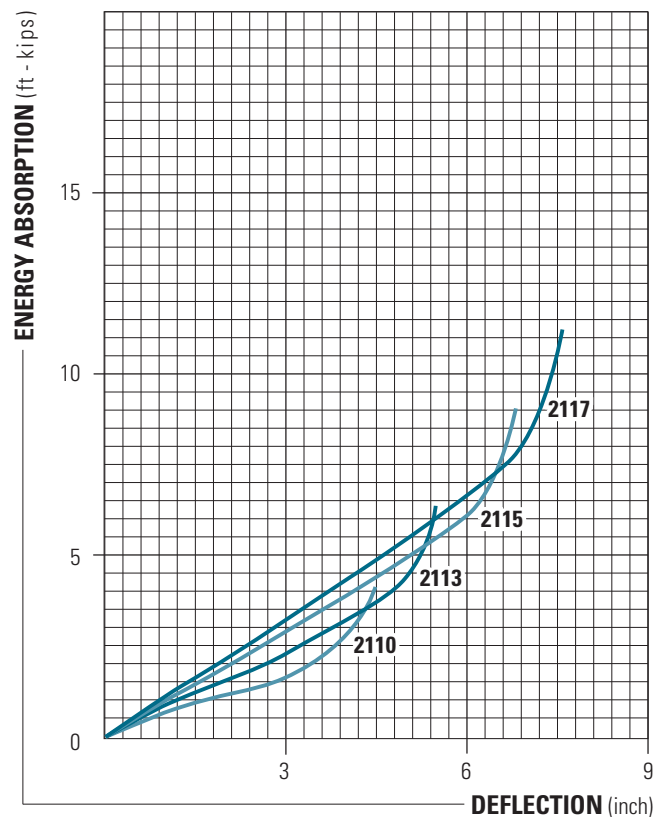
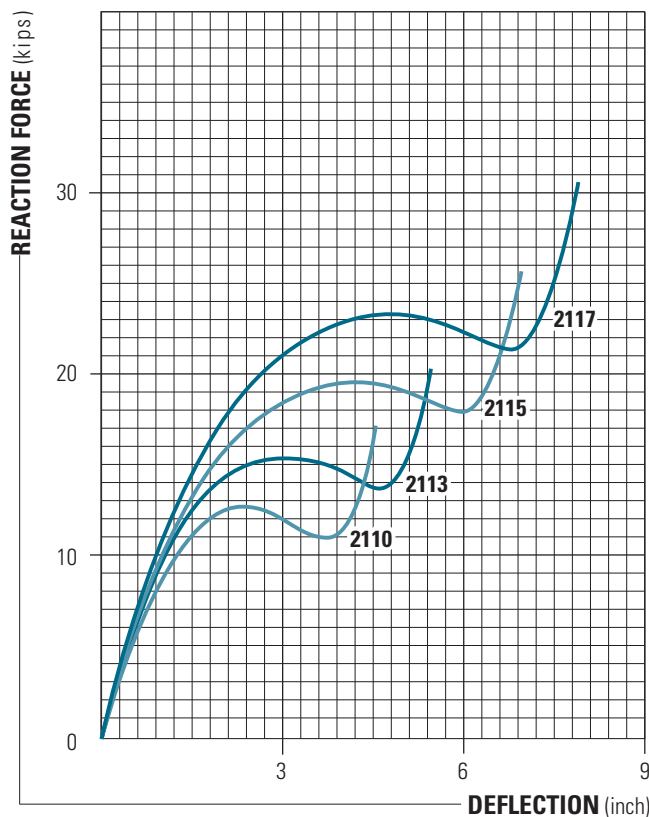



# Duramax® Tow Knee Pusher Plates

## Pushboats On Inland Waterways Trust Our Pusher Plates To Absorb The Abuse Of The Daily Grind.

Duramax® Tow Knees are among the most trusted impact absorbing pusher plates in the marine industry. They stand up to the test of time because we specialize in rubber to metal bonding - a process where tough rubber pads are securely vulcanized to steel or aluminum plates - and use only the highest quality materials.

- ▶ Duramax® segmented tow knees have built-in flexibility to conform with hull contour.
- ▶ Single, double or pre-curved models available options to suit every application.
- ▶ Steel or aluminum substrate plates are available in 1/4", 1/2" and 3/4" thicknesses.
- ▶ We stock a large inventory of tow knees ready for immediate shipment.

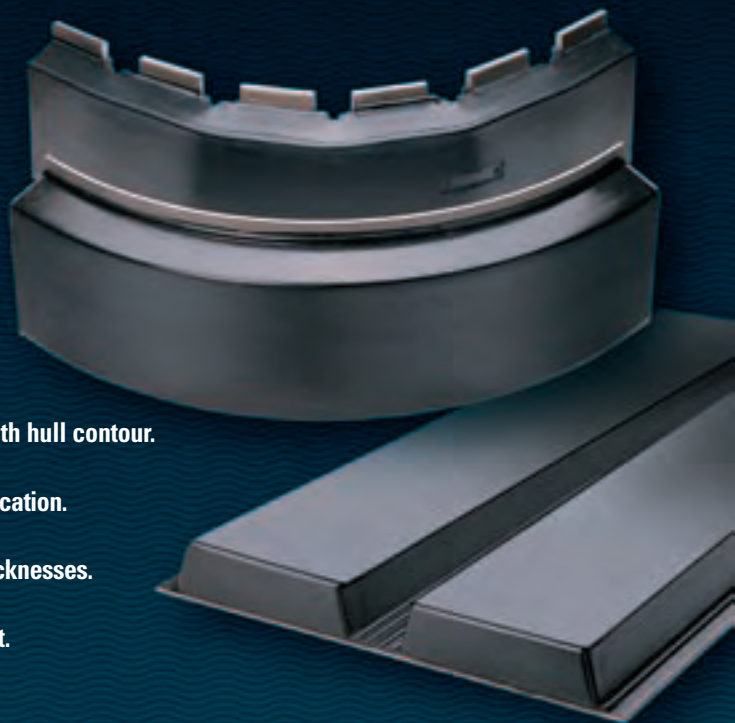

We Protect Vessels Around The World From Impact Damage In Rugged Operating Conditions And Harsh Environments.

**GOODYEAR** Call Toll Free: 1-866-711-4673

We Ship  
World Wide

# TOW KNEES *(CONTINUED)*

## SINGLE TOW-KNEES

Duramax Tow-Knees have a tough resilient 2" rubber pad bonded to a steel or aluminum plate. A proprietary bonding method is used for superior rubber to metal bond. This improves the wear life of the Tow Knee in the most demanding marine environments.

**Specify carbon steel or aluminum plate at time of order.**



**NOTE:** It is recommended that Tow Knees be only stitch welded. This is to prevent excessive heat build-up during installation.

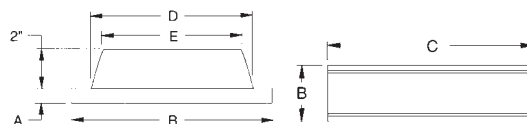

CODE NO.	DURAMAX® PART NO.	A THICKNESS	B WIDTH	C LENGTH	D BASE WIDTH	E SURFACE WIDTH	WEIGHT PER UNIT
DB-1408	802140806	3/4"	10"	36"	8"	7"	90 lbs.
DB-1409	802140906	1/2"	10"	36"	8"	7"	65 lbs.
DB-1410	802141006	1/4"	10"	36"	8"	7"	50 lbs.
DB-1508	802150806	3/4"	13-1/2"	36"	11-1/4"	10-1/4"	130 lbs.
DB-1509	802150906	1/2"	13-1/2"	36"	11-1/4"	10-1/4"	90 lbs.
DB-1510	802151006	1/4"	13-1/2"	36"	11-1/4"	10-1/4"	70 lbs.

\*See page 27 for Tow Knees Reaction Load/Deflection Chart

## DOUBLE TOW-KNEES

Double-wide Tow Knee reduces labor and welding time during installation.

**Specify carbon steel or aluminum plate at time of order.**



**NOTE:** It is recommended that Tow Knees be only stitch welded. This is to prevent excessive heat build-up during installation.

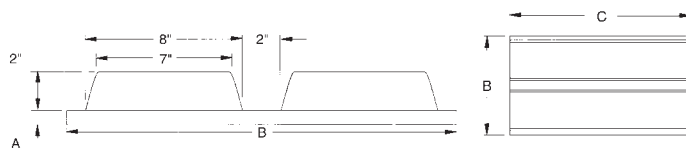

CODE NO.	DURAMAX® PART NO.	A PLATE THICKNESS	B WIDTH	C LENGTH	WEIGHT PER UNIT
DB-1608	802160806	3/4"	20"	36"	190 lbs.
DB-1609	802160906	1/2"	20"	36"	135 lbs.
DB-1610	802161006	1/4"	20"	36"	85 lbs.

\*See page 27 for Tow Knees Reaction Load/Deflection Chart

# TOW KNEES *(CONTINUED)*

## PRECURVED TOW-KNEES

For use in corner applications on vessels or dock structures.

**Specify carbon steel or aluminum plate at time of order.**

**NOTE:**

It is recommended that Tow Knees be only stitch welded. This is to prevent excessive heat build-up during installation.

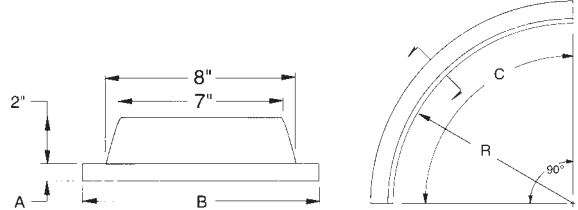

CODE NO.	DURAMAX® PART NO.	R RADIUS	A PLATE THICKNESS	B WIDTH	C LENGTH	WEIGHT PER UNIT
DB-1708	802170806	18"	3/4"	10"	28-1/4"	80 lbs.
DB-1709	802170906	18-1/4"	1/2"	10"	28-5/8"	60 lbs.
DB-1710	802171006	18-1/2"	1/4"	10"	29-1/16"	40 lbs.

\*See page 27 for Tow Knees Reaction Load/Deflection Chart

## SEGMENTED TOW-KNEES

Segmented tow knees have 6 independent 4"x10" welding plates that permit bending the tow-knee on a radius. The rubber pad has molded grooves in between the plates to reduce part stress at bend locations.

**Specify carbon steel or aluminum plate at time of order.**

**NOTE:**

It is recommended that Tow Knees be only stitch welded. This is to prevent excessive heat build-up during installation

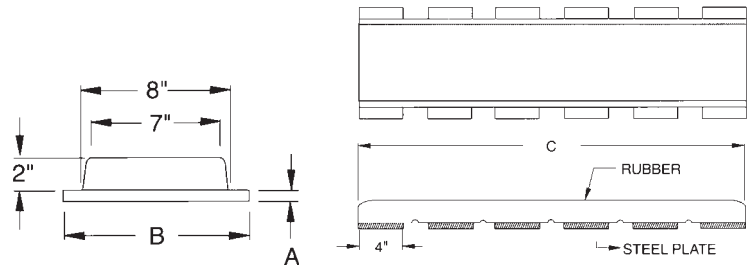

CODE NO.	DURAMAX® PART NO.	R RADIUS	A PLATE THICKNESS	B WIDTH	C LENGTH	WEIGHT PER UNIT
DB-1909	802190906	Variable	1/2"	10"	35-1/2"	53 lbs.

\*See page 27 for Tow Knees Reaction Load/Deflection Chart



# TOW KNEES (CONTINUED)

The chart to the right applies to all Tow Knees.

**Specify carbon steel or aluminum plate with any style Tow Knee at time of order.**

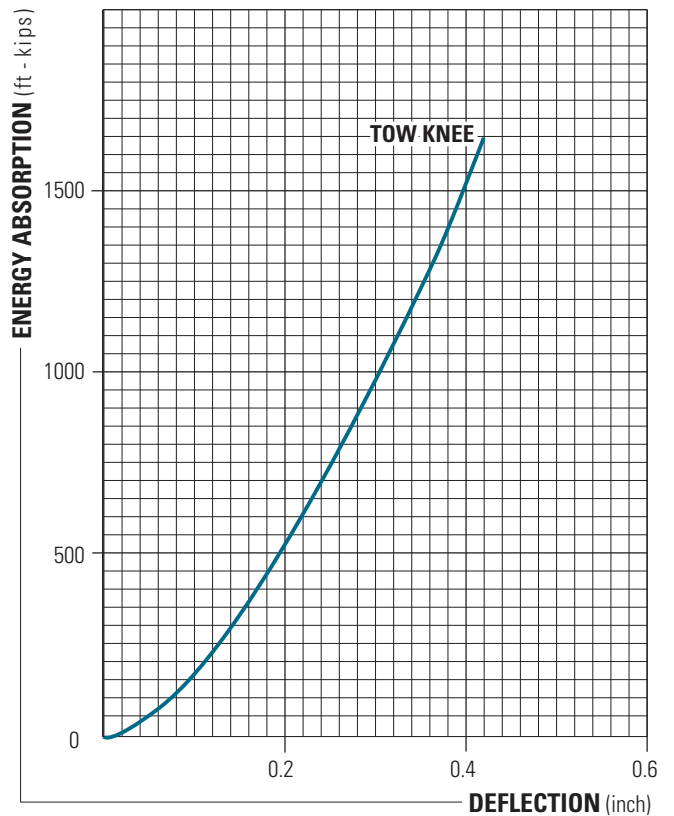
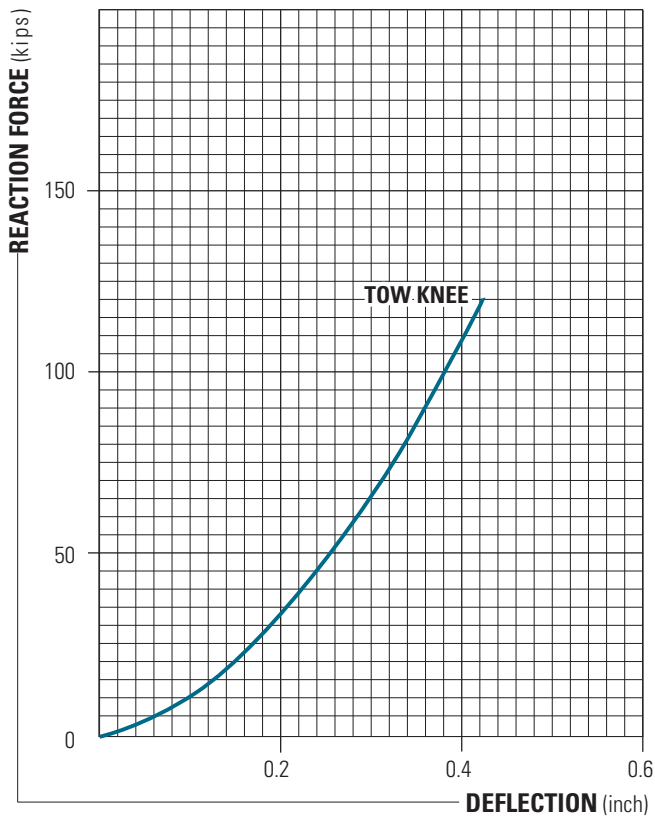
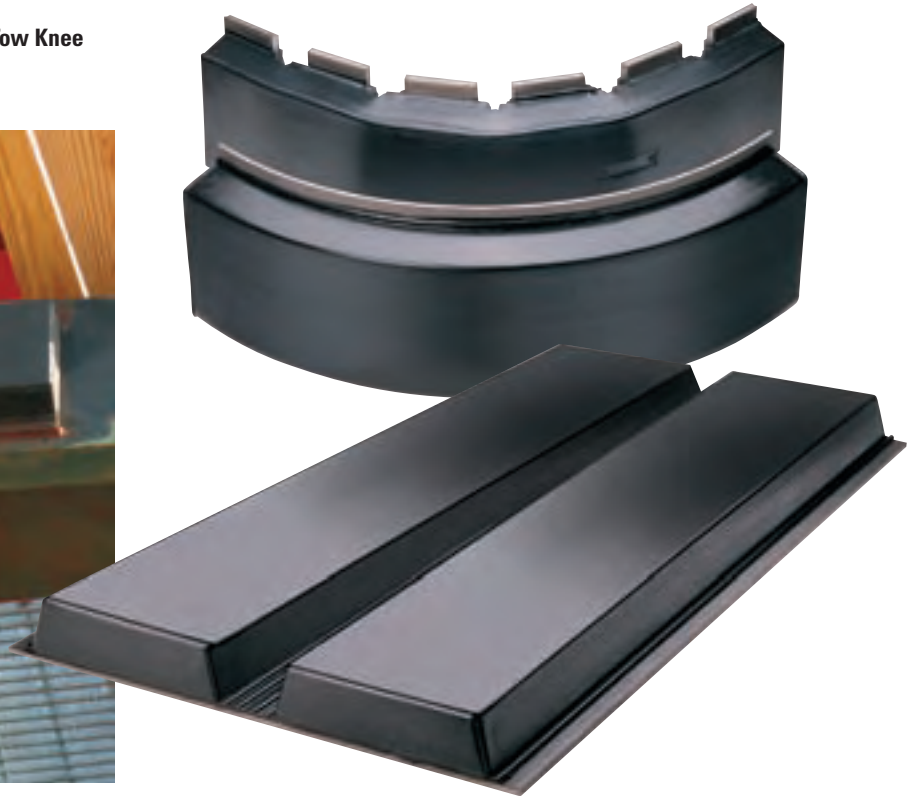





# Calculating Fendering System Requirements



## A vessel transfers its kinetic energy to surrounding environment.

A berthing vessel can only come to rest by transferring all its "motion energy" or "kinetic energy" to the surrounding environment. This motion or kinetic energy must be absorbed and dissipated by:

- a) The sea
- b) Elasticity of the fender
- c) Elastic deformation of the vessel's hull
- d) Elastic deformation of the pier

As evidenced by ships and harbors around the world, if the sea and fendering do not use their maximum energy absorbing capabilities, damage can result to vessel, berthing structure, or both.

## Proper fender needs to absorb vessel's kinetic energy.

When a marine fender is struck, it deflects. This deflection is proportional to the amount of kinetic energy it must absorb. As the fender deflects, it offers increasing resistance which is measured as a reaction load. This growing resistance by the deflecting fender is experienced by both the pier and the vessel's hull. A proper fender should be capable of absorbing this kinetic energy without offering a resistance so high that it might lead to structural damage of either the pier or vessel hull. Usually damage will occur when the fender is too small to absorb the resistance.

**Energy absorption is equal to the fender's deflection, times its resistance to deflection.** When a fender can only offer a small amount of deflection compared to the vessel's kinetic energy demands placed upon it, higher resistances result. This means, once the fender can deflect no further, the remaining kinetic energy is transferred to the pier and ship's hull. This can lead to berthing damage.

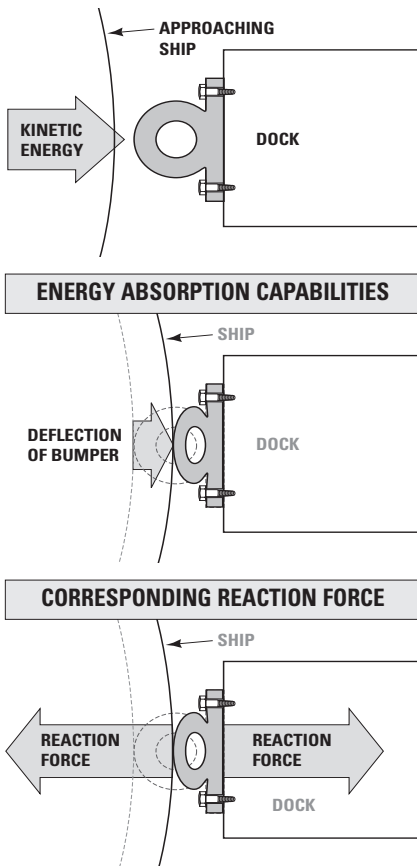

Generally, larger fenders offer greater energy absorption and lower reaction force compared to smaller fenders with the same geometry.

## 1.DETERMINING ABSORBED ENERGY OF A BERTHING SHIP

The absorbed energy of a berthing ship can be made by the following methods:

- a) Kinetic Energy Method
- b) Statistical Method
- c) Scale Model Tests
- d) Mathematical Modeling

The most commonly used approach is the KINETIC ENERGY METHOD. It is the traditional method and is subject to the judgement of the designer, however, it is time tested and seems to account for the major variables influencing vessel berthing.

The Kinetic Energy of the berthing ship is calculated using the formula:

$$E_{\text{Ship}} = 1/2 MV^2$$

Where  $E_{\text{Ship}}$  = Energy on Berthing

$M$  = Mass or Water displacement of the ship

$V$  = Approach Velocity of the ship at the moment of impact with the fender

This energy must be factored up or down, depending on rotation of the vessel on impact, the amount of water moving with the vessel thereby adding to its mass, the deformation of the ship's hull and the berth type.

# 1. DETERMINING ABSORBED ENERGY OF A BERTHING SHIP (Continued)

Therefore, Energy to be absorbed by the fender system is:

$$E_{\text{Fender}} = E_{\text{Ship}} \times f$$

Where

$$f = C_e \times C_m \times C_s \times C_c$$

$C_e$  = Eccentricity Factor

$C_s$  = Softness Factor

$C_m$  = Virtual Mass Factor

$C_c$  = Berth Configuration Coefficient

These variables are covered in detail on the following pages.

Also, convenient charts are provided in Section 2.3 which indicate the amount of berthing energy generated by various ship sizes under standard conditions.

## 2. CALCULATING BERTHING ENERGY

### 2.1 KINETIC ENERGY EQUATION

The equation detailing the variables:

$$E_{\text{Fender}} = 1/2 MV^2 \times C_e \times C_m \times C_s \times C_c$$

### 2.2 VARIABLES

#### a) Mass - M

One or more of the following weights should be readily available from the facility user:

Displacement Tonnage - DT

This is the weight of the water displaced by the immersed part of the ship.

Dead Weight Tonnage - DWT

This is the weight that the ship can carry when loaded to a specified load draft. (Includes cargo fuel, stores, crew, passengers.) It is the most common measurement.

Gross Tonnage - GT

This is based on the cubic capacity of the ship below the tonnage deck with allowance for cargo compartments above.

When calculating the mass - M, use the loaded displacement tonnage DT. Typically DT is 30% - 40% greater than DWT.

Where:  $M = \frac{DT}{g}$

DT = Displacement Tonnage (tonnes)

g = Acceleration Due to Gravity = 9.81 M/Sec<sup>2</sup>

#### b) Velocity - V

As can be seen from the Kinetic Energy Equation, the energy to be absorbed is a function of the square of the approach velocity. For this reason, DETERMINING THE VELOCITY IS ONE OF THE MOST IMPORTANT DECISIONS IN THE DESIGN. The choice of design velocity (velocity component normal to the dock) is a judgement based on ship size, site exposure and berthing procedure. Environmental aspects such as wind and current forces may be an influence. Section 2.4 b) describes how these forces can be calculated. Consultation with Port Management, ship operators and any other available information should be used when making the judgement.

The following chart is offered as a guide to assist in selecting a design velocity:

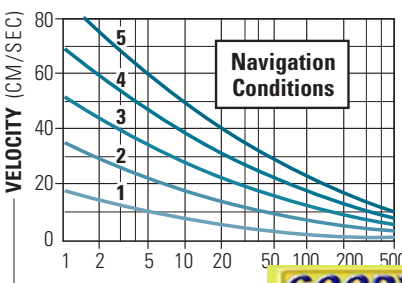

#### NAVIGATION CONDITIONS

1. Easy Docking; Sheltered
2. Difficult Docking; Sheltered
3. Easy Docking; Exposed
4. Good Docking; Exposed
5. Difficult Docking; Exposed

#### c) Eccentricity - C<sub>e</sub>

Usually the ship is not parallel to the pier face during berthing. As a result, not all of the Kinetic Energy will be transmitted to the fenders. At impact, the ship will start to rotate around the contact point thus dissipating part of its energy.

Schematic diagram of berthing ship

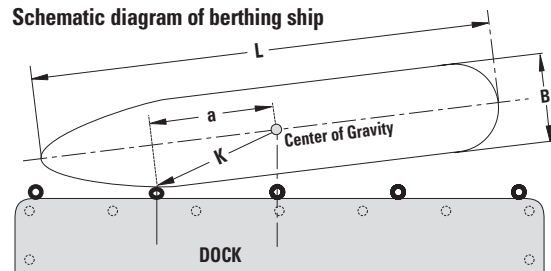

The following graph illustrates the relationship between the eccentricity coefficient and the distance "a" (as shown above).

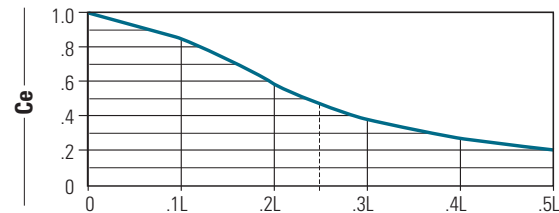

Alternatively, it is represented by the formula:

$$C_e = \frac{K^2}{a^2 + K^2}$$

Where:

K = radius of longitudinal gyration of the ship

a = distance between the ship's center of gravity and the point of contact on the ship's side projected onto the longitudinal axis (in terms of L - the ship's length)

The value of K is related to the block coefficient of the ship and its length.

It can be approximated by the following expression:

$$K = (0.19 C_b + 0.11) \times L$$

and the block coefficient C<sub>b</sub>

$$C_b = \frac{DT}{D \times B \times L \times W_0}$$

Where:

DT = Displacement of the ship (tonnes)

D = Draft (m)

B = Width (m)

L = Length (m)

W<sub>0</sub> = Water Density (tonnes/M<sup>3</sup>)

Typical Seawater W<sub>0</sub> = 1.025 tonnes/W<sup>3</sup> (64 lb/ft<sup>3</sup>)

Fresh Water W<sub>0</sub> = 0.9998 tonnes/W<sup>3</sup> (62.3 lb/ft<sup>3</sup>)

## 2. CALCULATING BERTHING ENERGY (Continued)

### c) Eccentricity – $C_e$ (Continued)

- for larger Bulk Ships and Tankers  
 **$K = 0.2L - 0.25L$**
- for Passenger Ships and Ferries  
 **$K = 0.17L - 0.2L$**
- for 1/4 point Berthing  
 **$a = 0.25L$**

The formula is based on the generally accepted assumptions that at the moment of maximum fender deflection:

1. Rotation only occurs at the contact point
2. Ship's hull does not slide along the fender
3. Forces such as wind, currents tugs are negligible compared to the fender reaction.

The approach angle is usually taken as  $7^\circ$  with a maximum of  $10^\circ$ . If the ship is berthing properly under control at the moment of contact with the fender then the direction of travel will be at right angles to the berthing face.

Examples:

In the case of a two dolphin mooring where the dolphins are  $1/3 L$  distance apart, the minimum  $C_e$  is reached when the center of gravity of the large ship falls halfway between the two dolphins on contact with the fenders. **This is when  $a = 1/6 L$**

Therefore:

$$C_e = \frac{(0.25L)^2}{(1/6L)^2 + (0.25L)^2} = 0.692$$

The maximum in this case, would occur when the ship's center of gravity falls in line with the point of contact with the fender or  **$a = 0$  Then  $C_e = 1$** .

In the case of a continuous fender system and a large oil tanker  **$a = 0.3L$**

Therefore:

$$C_e = \frac{(0.25L)^2}{(0.3L)^2 + (0.25L)^2} = 0.41$$

Generally  $C_e$  ranges between 0.4 and 0.8

### d) Virtual Mass Coefficient - $C_m$

When the ship is in motion and contacts the fender, the mass of the ship has to be decelerated as well as a certain mass of water surrounding and moving with the ship. This additional mass is accounted for in the virtual mass coefficient -  $C_m$  which is a function of: the block coefficient of the vessel, its draft and its width.

Where:

$$C_m = 1 + \frac{\pi}{4 C_b} \times \frac{D}{B}$$

$C_b$  = block coefficient (see section 2.2c)

$D$  = Draft

$B$  = Width

an alternate formula recommended by Vasco Costa is:

$$C_m = 1 + \frac{2D}{B}$$

Since there is no conclusive experimental data, we would recommend calculating  $C_m$  both ways and using the higher value.

### e) Softness Coefficient - $C_s$

This factor accounts for the relation between the rigidity of the ship and that of the fender. It expresses that proportion of impact energy absorbed by the fender. For a soft fender  $C_s = 1.0$  as deflection of the ship's hull will be negligible and therefore all the energy will be absorbed by the fender. In the instance of hard fenders, it is assumed that the ship's hull will absorb 2 to 7 percent of the impact energy so  $C_s$  is taken as 0.98 to 0.93.

### f) Berth Configuration Coefficient - $C_c$

This factor attempts to quantify the difference between an open pile supported pier and a solid sheetpile or concrete crib structure.

In the first case, the water being pushed by the berthing ship is easily able to be displaced around the pier. In the second case, the moving water is squeezed in between the structure wall and the ship causing a cushion effect. A reduction factor has to account for this effect.

For solid structures with parallel approach  $C_c = 0.8$ . As the approach angle increases from zero and as the under keel clearance increases then  $C_c$  increases to 1.0 which is the value for an open type support structure such as a pile supported pier.

## 2.3 VESSEL DIMENSIONS & TYPICAL ENERGY REQUIREMENTS

The following tables show typical weights and dimensions for the various vessel classes. These are general and should be used only as a cross reference.

A berthing energy has been calculated based on standard conditions where:

1. Velocity: 0.15 m/sec in all cases
2. Eccentricity Coefficient: 0.5 (for 1/4 point berthing)
3. Virtual Mass Coefficient: as shown
4. Softness Coefficient: 1.0
5. Berth Configuration Coefficient: 1.0
6. Large under keel clearance / open berth

### a) General Cargo

Tonnage (D.W.T.)	Length (in meters)	Width (in meters)	Height (in meters)	Loaded Draft (in meters)	Displacement Tonnage (DT)	Virtual Mass Coefficient	Berthing Energy (Tonne-M)*
800	56	9.0	4.0	3.8	1,115	1.6	1.02
1,000	58	9.4	4.6	4.2	1,390	1.59	1.27
2,500	83	12.4	6.7	5.5	3,470	1.58	3.15
5,000	109	15.0	8.4	6.7	6,930	1.57	6.23
7,500	129	18.0	10.2	7.7	10,375	1.59	9.48
10,000	142	19.1	11.1	8.2	13,800	1.56	12.32
12,000	150	20.1	11.9	8.7	16,500	1.55	14.73
15,000	162	21.6	12.7	9.1	20,630	1.52	18.02
20,000	180	23.5	14.0	10.1	27,400	1.54	24.19
25,000	195	25.0	14.5	10.3	34,120	1.50	29.35
30,000	200	26.0	15.7	11.0	40,790	1.48	34.62
35,000	210	27.2	16.2	11.7	47,400	1.49	40.50
40,000	217	28.3	17.3	12.0	54,000	1.47	45.52
45,000	225	29.2	17.9	12.4	60,480	1.46	50.65

\*These values are for general guidelines only. They should be checked using actual site conditions.

## 2. CALCULATING BERTHING ENERGY (Continued)

### b) Container Ships

Tonnage (D.W.T.)	Length (in meters)	Width (in meters)	Height (in meters)	Loaded Draft (in meters)	Displacement Tonnage (DT)	Virtual Mass Coefficient	Berthing Energy (Tonne-M)*
10,000	175	25.6	15.8	9.8	14,030	1.96	15.77
20,000	200	27.3	16.8	10.4	27,940	1.62	25.95
25,000	213	30.1	16.3	10.5	34,860	1.54	30.78
30,000	290	32.0	19.8	10.3	41,740	1.60	38.29
35,000	265	32.8	20.5	11.6	48,600	1.59	44.31
40,000	279	32.5	22.8	11.0	55,430	1.49	47.36
50,000	290	32.4	24.2	11.3	69,000	1.43	56.58

### c) Ore Carriers

Tonnage (D.W.T.)	Length (in meters)	Width (in meters)	Height (in meters)	Loaded Draft (in meters)	Displacement Tonnage (DT)	Virtual Mass Coefficient	Berthing Energy (Tonne-M)*
2,500	83	11.9	6.4	5.4	3,290	1.59	3.0
5,000	105	14.9	8.0	6.5	6,570	1.54	5.8
10,000	140	18.5	10.5	8.0	13,100	1.55	11.64
15,000	160	21.0	12.0	9.0	19,600	1.53	17.19
20,000	175	23.5	13.0	9.7	26,090	1.51	22.60
30,000	195	26.6	14.4	10.5	38,970	1.44	32.18
40,000	210	29.7	15.9	11.1	51,740	1.40	41.53
50,000	222	32.5	17.0	11.8	64,390	1.40	51.69
60,000	238	34.0	17.6	12.3	76,940	1.38	60.88
80,000	259	38.0	19.1	13.1	101,690	1.35	78.72
100,000	278	41.0	21.0	15.2	126,000	1.41	101.87
150,000	310	45.5	25.0	17.6	184,840	1.42	150.50

### d) Tankers

Tonnage (D.W.T.)	Length (in meters)	Width (in meters)	Height (in meters)	Loaded Draft (in meters)	Displacement Tonnage (DT)	Virtual Mass Coefficient	Berthing Energy (Tonne-M)*
1,000	58	9.4	4.5	4.2	1,360	1.60	1.25
2,500	82	12.0	6.1	5.5	3,400	1.59	3.10
5,000	102	15.0	7.7	6.5	6,790	1.51	5.88
8,000	126	15.7	9.0	7.4	10,600	1.52	9.24
10,000	140	19.0	9.8	7.9	13,540	1.52	11.80
15,000	163	20.0	11.2	8.6	20,250	1.48	17.19
20,000	175	23.5	12.3	9.6	26,930	1.48	22.85
30,000	195	27.0	14.1	10.7	40,190	1.45	33.41
40,000	213	29.6	15.2	11.8	53,300	1.45	44.31
50,000	224	32.0	16.6	12.3	66,270	1.41	53.58
60,000	236	34.0	17.7	12.7	79,100	1.39	63.04
70,000	248	35.8	18.6	13.5	91,790	1.40	73.69
85,000	260	38.1	18.7	14.0	110,550	1.37	86.84
100,000	285	40.1	21.1	14.8	129,000	1.39	102.820
150,000	300	46.1	24.3	17.0	188,200	1.37	147.84

\*These values are for general guidelines only. They should be checked using actual site conditions.

## 2.4 OTHER FACTORS TO CONSIDER

Now that the fender design has been narrowed down to a couple of options, the designer must look at a number of other considerations and decide whether or not they are important in his design.

The following are a few common considerations:

### a) Fender Performance Characteristics

Not only must the fender design absorb the required berthing energy, but the designer must also consider the reaction loads that this system will impart to the structure. The reaction loads and their location may have a significant impact on the structure design. Generally the reaction loads are not a problem with gravity structures, however, with pile supported piers, the reaction loads may become critical to the design and may influence such things as batter pile locations and the rebar design.

### b) Fender Spacing

Fender spacing along the pier face is an important design consideration. Here the designer is trying to maximize protective pier coverage while minimizing the fendering costs.

There are three standard methods.

- i) Fender spacing of not more than 1/10 the length of the vessel.

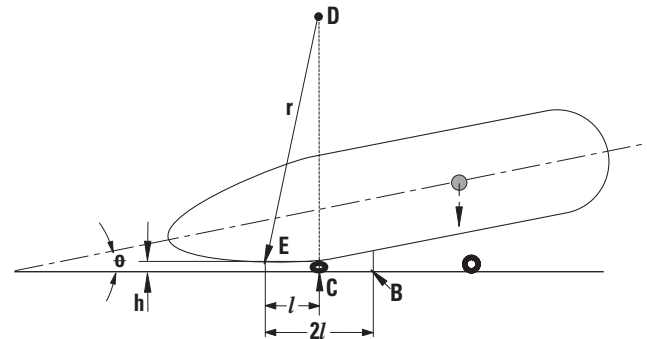

- ii) Using the vessel's geometry along with the above configuration, the following formula can be developed:

$$2l = 2 \sqrt{r^2 - (r - h)^2}$$

Where:

**r** = the bent radius of the ship's hull at the contact line.

**h** = the compressed height of the fenders at their rated deflection.

Some typical bow bent radius values are shown below. Exact values from the vessel should be used.

Approach Angle	Contact Line	General Cargo* 10,000 DWT	General Cargo* 30,000 DWT	Ore Carrier* 35,000 DWT	Tanker* 50,000 DWT
1°	Load line	209	230	240	240
	Upper Deck	155	200	360	240
5°	Load line	54	70	85	110
	Upper Deck	53	70	100	85
10°	Load line	44	60	70	75
	Upper Deck	40	65	55	60

\*Units = Meters



## 2. CALCULATING BERTHING ENERGY (Continued)

### b) Fender Spacing (Continued)

iii) From the site conditions.

The fender spacing can be determined using the wind and current forces and equating them to the fender reaction forces. **Use the following formula:**

$$N = \frac{R_a + R_c}{R}$$

Where:

- N** = Number of fenders required
- R<sub>a</sub>** = Load due to wind (see below)
- R<sub>c</sub>** = Load due to current (see below)
- R** = Fender Reaction at rated deflection

### Wind Loads

The wind loads can be calculated using the following formula:

$$R_a = 1/2 \times d_a \times (V_w)^2 \times C_w \times (A \cos^2 \theta + B \sin^2 \theta)$$

Where:

- R<sub>a</sub>** = Force due to wind (kg)
- d<sub>a</sub>** = Force of air (= 0.12 kg. sec<sup>2</sup>/m<sup>4</sup>)
- V<sub>w</sub>** = Wind Velocity (m/sec)
- C<sub>w</sub>** = Wind pressure coefficient
- A** = Area of the front projection of the vessel above sea level (m<sup>2</sup>)
- B** = Area of the side projection of the vessel above sea level (m<sup>2</sup>)
- θ** = Angle of wind direction relative to the centerline of the vessel.

The wind pressure coefficient is relative to the angle of wind direction as shown in the table below:

Wind Direction θ°	0°	20	40	60	80	100	120	140	160	180
<b>C<sub>w</sub></b>	1.08	1.03	1.18	1.09	0.98	0.94	1.0	1.15	1.28	0.99

### Current Loads

The loading on the vessel due to current pressure is calculated as follows:

$$R_c = 1/2 \times d_w \times C \times (V_c)^2 \times L \times D$$

Where:

- R<sub>c</sub>** = Reaction load due to current (kg)
- d<sub>w</sub>** = Water Force Coefficient (= 104.5 kg. sec<sup>2</sup>/m<sup>4</sup>)
- C** = Current Pressure Coefficient
- V<sub>c</sub>** = Velocity of the current (m/sec)
- L** = Vessel Length (m)
- D** = Vessel Draft (m)

Current Direction θ°	C		
	H/D = 1.1	H/D = 1.5	H/D = 7.0
0	0	0	0
20	1.2	0.5	0.3
40	3.1	1.3	0.6
60	4.1	2.1	0.8
80	4.6	2.3	0.9
100	4.6	2.2	0.8
120	4.0	1.8	0.7
140	2.8	1.3	0.5
160	1.0	0.5	0.3
180	0	0	0

**H** = Water Depth    **D** = Draft

The Current Pressure Coefficient is relative to the angle of current direction and to the water depth to draft ratio.

### c) Normal Operations

i) Stand Off Distance

The allowable standoff distance will be governed by the loading/unloading activities and the normal operating procedures of the ship and pier while berthed. Operating constraints such as crane reach, roll, yaw and freeboard are major considerations in the design. The fenders must provide adequate protection yet accommodate the design.

ii) Vertical vs. Horizontal Mounting

There is an ongoing concern as to when the fenders should be mounted horizontally and when vertical. In general, vertically mounted fenders provide the best coverage for piers which experience tidal fluctuations. Where the operating procedures require that the vessel slide along the pier face, horizontal Bolton fenders provide good protection. A combination of horizontal and vertical arrangements are often used.

iii) Tidal Variation

The change in water level due to tides will have a significant impact on the operation of the pier and consequently the pier design and the fender design as well. Protection in all cases must be achieved for both the largest and smallest ships.

iv) Range of Ship Sizes

While the energy absorption capacity of the fender system is chosen for the design vessel, the fender system should be suitable for the full range of ships expected to use the facility. Fender stiffness on the smaller vessels may have an influence on the arrangement of the fenders. Also, if barges are to use the facility, special attention must be given to their fender requirements.

v) Frequency of Berthing

A high frequency of berthings normally justifies greater capital expenditures for the fender system.

### d) Accidental Impact

The fender system is less expensive than the dock structure and it should be recognized that damage to the fenders is less critical than to the vessel or the structure. The design should incorporate a reasonable level of energy absorbing capacity. If the fender system fails, it would be an advantage if the structure were designed so that it could inexpensively be repaired. The mode of failure of a fender and its effect on the dock structure should be considered.

### e) Ongoing Maintenance Costs

Maintenance costs can be an important factor and should be considered when analyzing the overall costs of the various fender options. Maintenance costs will vary with fender type.

### f) Ease of Installation

A well designed fender system will be as easy to install as possible. This will minimize initial capital costs and reduce down the road maintenance costs.

### 3. CONVERSION TABLES

DISTANCE			
From	To	Factor	Reciprocal
Inch	mm	25.4	0.03937
ft.	m	0.3048	3.2808
Yd.	m	0.9144	1.09361

VELOCITY			
From	To	Factor	Reciprocal
cm/sec	ft./min.	1.969	0.508
cm/sec	ft./sec.	0.0328	30.48
Knot	ft./sec.	1.689	0.592
miles/hr	ft./min.	88.0	0.0114
miles/hr	Km./hr.	1.609	0.6215
m/sec	ft./sec.	3.281	0.3048

FORCE			
From	To	Factor	Reciprocal
Kg	lbs.	2.205	0.454
Kips	lbs.	1000.0	0.001
Kips	Tonnes	0.454	2.205
Tons (long)	lbs.	2240.0	0.000446
Newtons	lbs.	0.225	4.45
Kg	Newtons	9.807	0.102

ENERGY			
From	To	Factor	Reciprocal
ft.-Kips	Tonne-Meters	0.1383	7.235
ft.-lbs.	Newton-Meters	1.356	0.738
Tonne-Meters	KN-Meters	9.807	0.102

PRESSURE			
From	To	Factor	Reciprocal
lbs./ft. <sup>2</sup>	Kg/m <sup>2</sup>	4.882	0.2048
lbs./ft. <sup>2</sup>	psi	0.006944	144.0
psi	Kg/m <sup>2</sup>	702.9	0.00142
tonne/m <sup>2</sup>	Kips/ft. <sup>2</sup>	0.2048	4.882
tonne/m <sup>2</sup>	KN/m <sup>2</sup>	9.807	0.1020
Kips/ft. <sup>2</sup>	KN/m <sup>2</sup>	47.86	0.02090

# The Ultimate Shock Absorber.

LINERITE® composite batterboard is an engineered product designed specifically for high frictional wear applications where heavy impacts occur. It absorbs impact energy, has a delayed elastic response and provides a nearly indestructible layer of protection.

It is a unique, relatively hard and dense material that is a long-lasting, highly effective, environmentally friendly batterboard that is a perfect replacement for wooden timbers.

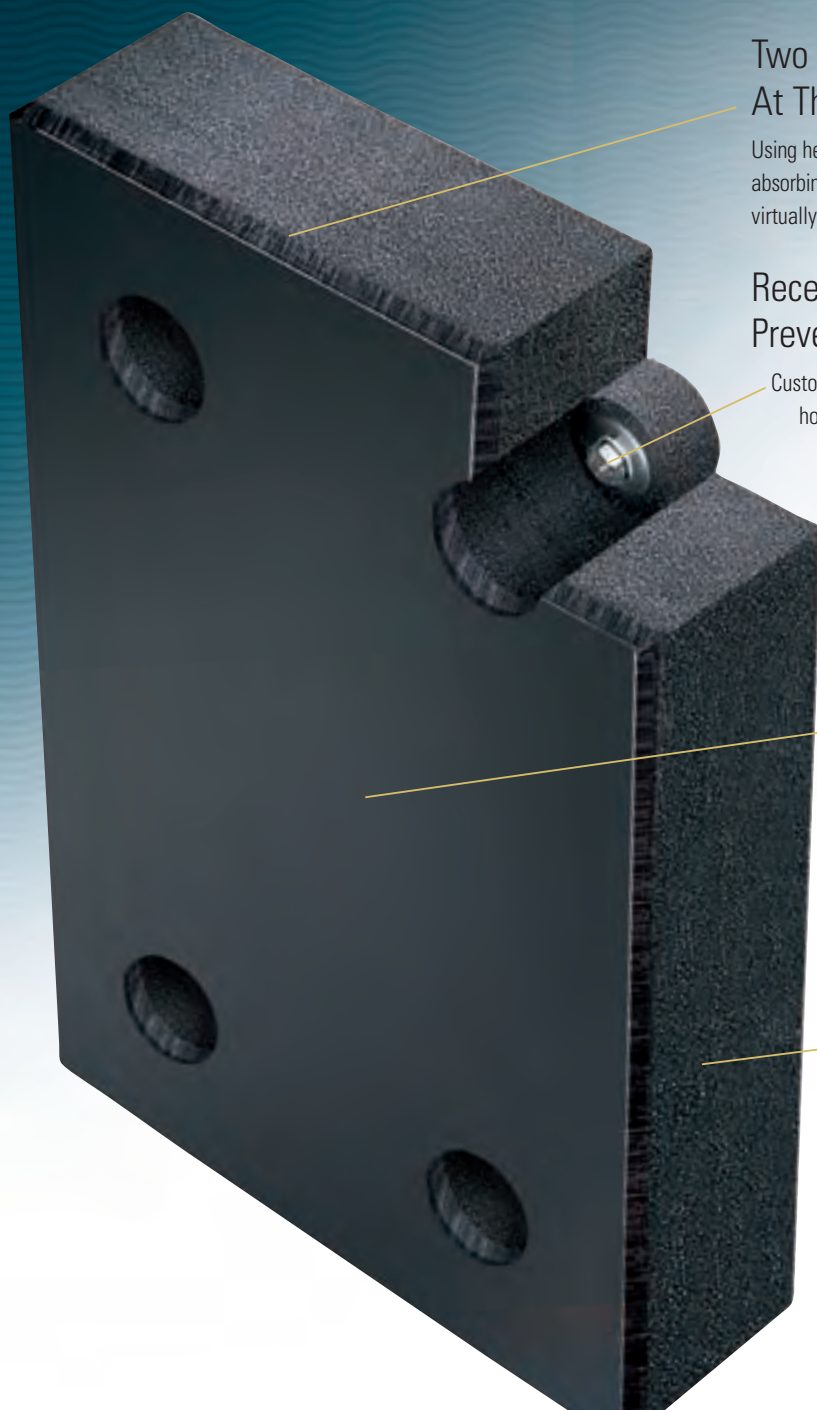

## Two Integral Materials Fused Together At The Molecular Level.

Using heat and extreme pressure, LINERITE'S UHMW-PE facing and impact-absorbing core is blended into a remarkable composite product structure that is virtually impossible to separate.

## Recessed Stud Fastener System Prevents Shearing.

Custom fabricated recessed mounting holes reduce bolt stress and prevent dangerous shearing of bolts or studs during impact.

## 0.12 Low-Coefficient Of Friction UHMW-PE Facing.

The Ultra High Molecular Weight Polyethylene (UHMW-PE) facing layer material protects and extends the wear life of your vessel, pilings and dock structure.

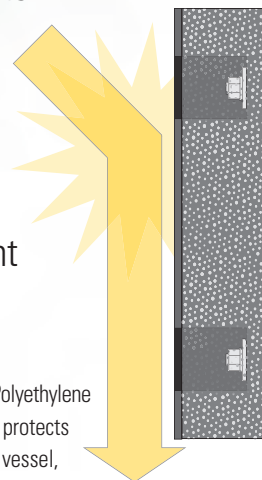

## Proprietary Energy Absorbing Composite Core

At impact, LINERITE® compresses absorbing impact energy and then slowly returns to its original shape. This process can take from a few seconds to several minutes. Other materials either don't absorb the energy or they absorb it initially and then transmit it back to the vessel in a sling shot effect.

**SUPERIOR ENERGY ABSORPTION**  
Absorbs force with room to bulge on impact

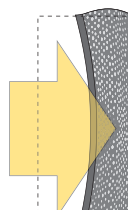

**DELAYED ELASTIC RESPONSE**  
Returns To Original Dimension in 5 Sec. - 1 Hr.

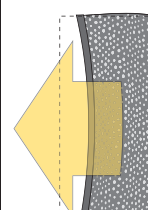

**VIRTUALLY INDESTRUCTIBLE**  
Withstands repeated heavy loads & impacts



# LINERITE® vs. Wooden Timbers Comparison Chart



	LINERITE®	Wooden Timbers
Water Absorption	0.02%	100%
Oil Exposure	Negligible effect	Needs replacement
Marine Organism	Inert	Shortens life
Chemicals	Resistant to all chemicals	Deteriorates
Freezing Temperatures	Unaffected	Cracks
Flame Spread	14	34
Environmental Safety	Environmentally friendly	Leaches harmful chemicals
Maintenance	Practically none	High maintenance
Service Life	Virtually indestructible	replaced often

## Pre-curved for easy installation

Duramax® will engineer an impact system that will perfectly match your application. This will save installation time and money.

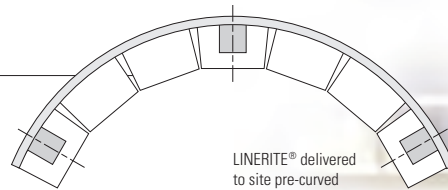

## Custom sizes & fabrication available

LINERITE® can be manufactured to the right length, width and thickness, and then drilled to meet your installation requirements. Complex angles and shapes are no problem.

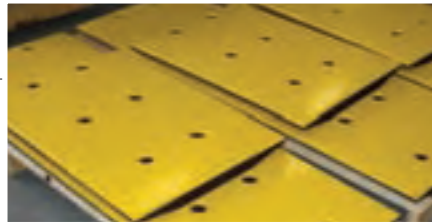

## Custom mounting holes

Our recessed stud fastening system is custom fabricated to fit your application perfectly, making on-site installation easy and less costly. Also, LINERITE® is lightweight making it easy to handle.

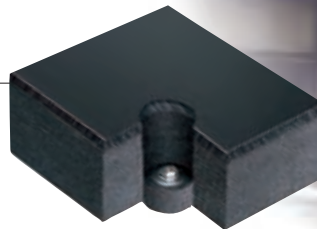

## Custom color

LINERITE® UHMW-PE facing comes in black and yellow as standard colors. The face material can be manufactured to match any custom color.

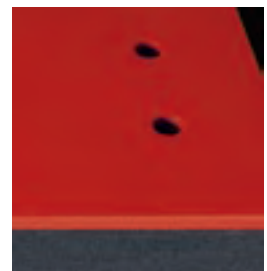
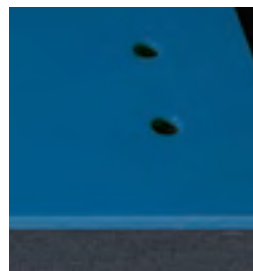



INNOVATION.  
EXPERIENCE.  
RESULTS.

Duramax Marine® is committed to providing excellence in every product we manufacture. Our Johnson Cutless® marine and industrial bearings, heat exchangers, impact protection systems and sealing systems are known worldwide for their engineered quality and dependable performance. Please contact the factory for information on any of the following Duramax Marine® products:

## JOHNSON CUTLESS® WATER-LUBRICATED BEARING SYSTEMS

Johnson Cutless® Sleeve and Flanged Bearings  
DX 490 Rudder Bushings



## DURAMAX® ADVANCED WATER-LUBRICATED BEARING SYSTEMS

Johnson® Demountable Stave Bearings  
ROMOR® I Stave Bearings and Segmental Housings  
ROMOR® C- Partial Arc Bearings  
DMX® Polymer Alloy Bearings  
Industrial Pump Bearing Systems



## DURAMAX® HEAT EXCHANGE SYSTEMS

DuraCooler® Keel Coolers  
Duramax® Demountable Keel Coolers  
Duramax® BoxCoolers

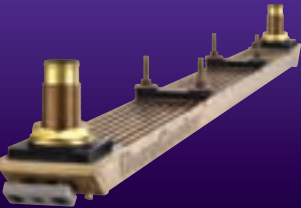

## DURAMAX® IMPACT PROTECTION SYSTEMS

Johnson® Commercial Dock Bumpers, Fenders & Tow Knees  
Weatherstrip Door Gaskets, Window Channel and Hatch Cover Gaskets  
LINERITE® Composite Batterboard Systems

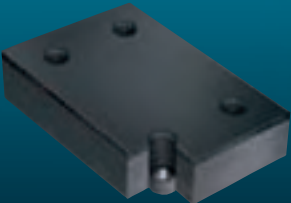

## DURAMAX® SHAFT SEALING SYSTEMS

Duramax® Shaft Seal Systems  
Johnson® Heavy-Duty Air Seal Stuffing Boxes  
Duramax® Ultra-X™ High Performance Compression Packing  
Johnson® Strong Boy Stern Castings and Stuffing Boxes



**GOODYEAR** Call Toll Free: **1-866-711-4673**

**We Ship  
World Wide**