



Conveyor Belt Fabric Splice Manual

Table of Contents

I. Splice Technologies

Splicing Best Practices	2
Splice Materials - Do's and Don'ts, Age Limits	3
Most Common Fabric Splice Mistakes	4

II. Belt Installation

Belt Storage and Installation	5
Handling the Roll of Conveyor Belt	5
Stringing the Belt	6
Tensioning the Belt	7
Take-Up Travel and Initial Position	8
Cutting the Belt to Length	9

III. Fabric Splice Preparation

Preparation of Work Area	10
Splice Tools	11
Direction of Splice and Bias	13
Existing Splices Loaded onto a Conveyor System	14
Establishing a Master Line	14
Establishing a Center Line	15
Dry Fit Splice Alignment	15
Addressing Belts with Damaged Edge(s)	15
Addressing Belts with Unequal Widths	15

IV. Vulcanizing

Cure Time and Temperature	16
Pressure	16
Power Failure: 50% Rule	17
Pressure Failure	17
Vulcanizing the Splice	17
Press Platen Cooling	18
Splice Completion	18
General Curing Notes	18

V. Belt Splicing Procedures

Fabric Belt Bias Step Splice	19
Splice Dimensions	19
Splice Bias	19
Procedures	19

Bias Step Finger Splice	26
--------------------------------	-----------

Long Life Full Carcass Finger Splice	29
---	-----------

ContiPipe™ Belt Splicing	34
---------------------------------	-----------

Mechanical Splice (Fasteners)	36
--------------------------------------	-----------

Squaring the Belt End	36
Classes of Mechanical Fasteners	36
Tightening Fasteners	37
Hazard to the Belt	37
Fasteners for Special Requirements	37
Fastener Application Cover Skive Instruction	38

Elevator Belt Splice	40
-----------------------------	-----------

Installation	40
Splicing	40
Attaching Buckets	41

Solar-Shield® XL 750 Splicing	42
--------------------------------------	-----------

Splice Dimensions	42
Splice Bias	42
Step Length/Curing Chart	42
Splicing Material	43
Building the Fill Strips	43
Procedure	43

Special Belt Splices	48
-----------------------------	-----------

Wedge-Grip	48
Bareback	48
Cleated Belt	48
Fold Belt 600 2 Ply	49

I. Splice Technologies

Splicing Best Practices

White Dot Procedure

1. The White Dot Procedure is a method to identify the "Factory Cut Edges" of narrow belts that are slit from wider belts.
2. On rare occasions the narrow belts may camber or bow towards the Factory Cut Edge side of the slit belts.
3. The Factory Cut Edges are clearly marked and identified from the factory before shipping the belt.
4. The words "Factory Edge" are spray painted on the side of the belt.
5. When the narrow slit belts are being spliced together on the same conveyor, the Factory Cut Edges must be aligned on the same side of the conveyor.
6. To match the Factory Cut Edges on the same side of the conveyor, one of the narrow slit belts must be re-rolled. This belt will have the "Factory Edge" side marked as well as "Re-Rolled" spray painted on the other side of the belt.
7. Many times belts that bow/camber can run straight on the system after initiating belt tension and running the belt for a break-in period. However, some belts that bow/camber may be difficult/impossible to train and run straight on the system without matching up the "Factory Cut Edge" sides on the same side of the conveyor system.

Building the Fill Strips

1. A leading cause of fabric belt premature splice failures is the breakdown of the fill strips.
2. The typical specified cover skive is 4 in. at the base x full width.
3. Cover rubber skives are cut at 45° angles. Buff the cover skives and approximately one inch of the surrounding belt cover.
4. Remove all buffing debris from the splice area.
5. Using a clean, lint-free cloth, wipe the 45° cover skives and the buffed surrounding rubber with the specified solvent.
6. The ply seam/joints must have a 1/32 in. to 1/16 in. gap. Do not butt the fabric plies tight or allow them to overlap.
7. Apply one even layer/coat of the specified cement to the exposed fabric only. Do not cement the 45° cover skives.
8. Allow the cement to dry until tacky. Do not allow the

9. Place a noodle or narrow strip of the inside rubber over the ply seam/joint.
10. Apply a sheet of the specified inside rubber over the fabric surface only. Do not allow the inside rubber to advance onto or over the 45° cover skives.
11. Using a porcupine roller, roll the sheet of inside rubber flat and remove all possible trapped air.
12. Using a clean, lint-free cloth and the specified solvent, wipe the top surface of the freshly installed inside rubber sheet.
13. Using a clean, lint-free cloth and the specified solvent, wipe the bottom surface of the specified breaker.
14. Apply the breaker over the ply seam/joint. Carefully center the breaker so that equal lengths are positioned on each side of the ply seam/joint.
15. The breaker is approximately 3.5 in. x full width. This will allow approximately 1/4 in. of space from each edge of the breaker to the base of the 45° cover skive.
16. Do not allow the breaker to advance to the 45° cover skive.
17. Using a porcupine roller, roll the breaker flat and remove all possible trapped air.
18. Using a clean, lint-free cloth and the specified solvent, wipe the top surface of the breaker and the bottom of the specified cover rubber.
19. Install the cover rubber. Be sure of a tight fit against the 45° cover skives.
20. Using an awl, puncture holes throughout the cover rubber insert.
21. Using a small straight edge verify that there is sufficient rubber in the fill strip area to prevent low pressure.

Ply Seam Gaps

1. All ply seams must have a gap measuring approximately 1/32 in. to 1/16 in. wide.
2. Never butt the ply seams/joints tight together.
3. Never allow the ply seams/joints to overlap.
4. Place a noodle or narrow strip of inside rubber over the ply seams/joints.
5. Each ply seam/joint must be properly aligned using steps

GOODYEAR
GOODYEARBELTING.COM

Call Toll Free: 1-866-711-4673
International: +1-727-342-5086

**We Ship
World Wide**

Proper Storage, Handling and Use of Splice Materials

1. It is the responsibility of the splicing company and/or the end user/customer to properly store and handle all splice materials. It is also their responsibility to dispose of any unused or unwanted materials properly.
2. Material shelf life may be extended if stored in a refrigerated storage area.
3. Each material will have the Refrigerated and Non-refrigerated date posted on them.
4. Do not use splice materials that have exceeded their shelf life/expiration dates.
5. Keep all splice rubber completely wrapped with film/poly.
6. All splice materials must maintain identification and expiration periods attached.
7. Non-refrigerated splice materials must be kept away from and out of direct sunlight and heat.
8. All splice materials must be stored in a clean, dry and cool environment.
9. Do not store splice material near electrical motors or in a possible wet environment.
10. Avoid condensation of materials immediately before use.
11. Avoid repeatedly handling open splice rubbers with dirty/oily gloves and/or hands.
12. Wipe all rubber surfaces with a clean, lint-free cloth and the specified solvent.
13. Roll all rubber sheets in place using a flat roller and a porcupine roller.

Curing Rules

1. Never shorten the splice to fit into a vulcanizer without the approval of the belt manufacturer.
2. Be certain the vulcanizer can meet the specified cure time temperature and pressure throughout the cure cycle.
3. Use a minimum of one thermocouple per heating element/zone.
4. Follow the belt manufacturer's specified cure time, cure temperature and cure pressure.
5. Use steel or aluminum edge guides against the edges of the splice and adjacent belt ends. The edge guides are to be approximately 1/16 in. less gauge than the belt gauge (not the splice gauge).
6. Use steel or aluminum guides thinner than the edge guides as balance guides.
7. Cool the finished splice and platen to at least 130°F

50% Rule - Be Here Now - In Case of Power Failure

1. It is very important that someone is watching over the vulcanizer and documenting the cure time, the cure temperature from each thermocouple and the cure pressure at given intervals throughout the cure cycle.
2. In case of a power failure while curing the splice, do not release or lower the curing pressure, but hold it until power is restored and then bring the vulcanizer back to cure temperature. At that time:
 - If the splice had less than half its specified cure time before the power failure, repeat the entire splice.
 - If the splice had cured one half or more than the specified cure time, then finish curing the remaining time after all the thermocouples again register the specified cure temperature.
3. If the vulcanizing pressure is lost on the surface of the splice, the splice must be remade.

Splicing Rules

1. Follow the specified dimensions for the splice.
2. Never change or alter the splice dimensions without the approval of the belt manufacturer.
3. Use only the compatible specified splice materials.
4. Cure according to the belt manufacturer's specifications.
5. Follow the belt manufacturer's established best practices for splicing.
6. Document each splice including the splice materials used and their expiration dates.

Splice Materials - Do's and Don'ts, Age Limits

1. Do stir cements thoroughly before and during use. Cements that have jelled or remain jelled/settled out after stirring are not to be used.
2. Do keep cans of cement tightly sealed and stored in a cool dry area. Refrigeration of some cements are recommended. See chart on page 4. Recommended refrigeration temperature of 45°F to 55°F (7°C to 12°). Avoid freezing cements.
3. Do keep uncured splice rubber clean, sticky and protected by film/poly. Use the specified solvent to wash uncured rubber surfaces before use.
4. Do minimize handling of clean splice rubber and fabrics.
5. Do permit refrigerated splice materials to come to or near the ambient temperature before using to avoid

7. Do handle splice materials in accordance with all federal, state and local laws. Become familiar with MSDSs for all materials.
8. Do use only the specified materials for the belt to be spliced.
9. Do not use splice materials that are beyond their shelf life/age limits.
10. Do not store splice rubber in direct sunlight or heat.

Age Limits	Unrefrigerated (But Cool and Dry)	Refrigerated
All Rubber and Breakers Except Solar-Shield® XL 750	6 Months	12 Months
Solar-Shield® XL 750 Rubber and Coated Breakers	3 Months	6 Months
M-856-C Cement	3 Months	6 Months
M-924-C Cement	3 Months	6 Months
M-1200-C Additive Cement	6 Months	12 Months
VTI-600-FC Cement/Fabric Belt Splices	18 Months	N/A
VTI-900-SCC Cement/Steel Cable Splices	18 Months	N/A
M-750-C Cement	6 Months	12 Months
M-916-C Cement	6 Months	12 Months
M-918-C Cement	6 Months	12 Months
M-920- C Cement	6 Months	12 Months

Most Common Fabric Splice Mistakes (That Lead to Premature Splice Failure)

1. **Over Cure or Under Cure** of splice rubber resulting from improperly controlled platen temperatures. Continental ContiTech specifies a minimum of one thermocouple per heating element used.
2. **Nicking or cutting the fabric plies**, thereby damaging the warp and fill cords.
3. **Buffing the fabric**. Do not directly buff the fabric surfaces.
4. **Curing the splice with wet cement** can cause ply and/or cover blows
5. **Over prodding the fabric** when lifting the plies will damage the warp and fill cords.

6. **Reducing the specified step lengths** of the splice to fit into a short vulcanizer or to save time will significantly reduce the vulcanized splice strength.
7. **Assembling a splice with contamination** can reduce ply and cover adhesion/bonding.
8. **Using over age, incorrect or improperly stored materials** can significantly reduce ply and cover adhesions.
9. **Using incorrect compounds and/or cements** can significantly reduce adhesions as well as cause ply and cover blows.
10. **Improper splice alignment** can cause off-center tracking.
11. **Overlapping and/or misaligned plies and/or carcass fingers:** Align the splice with a gap of approximately 0.063 in. (1.6 mm) at ply seam/joint and between fingers. Fill the gaps with the specified inside rubber.



Call Toll Free: 1-866-711-4673
International: +1-727-342-5086



II. Belt Installation

Belt Storage and Installation

1. The methods of storing and handling Conveyor Belting and the procedures for tensioning it before making the final splice are just as important as actually making the splice.
2. New conveyor belting should be stored upright in the factory package until used. A cool dry room, free from sunlight, steam pipes, oil and corrosive fumes is best. Under no circumstances should a roll of belting be stored on its side, even if on a concrete floor.
3. Moisture will shrink any exposed fabric that gets damp from such storage and the belt may "bow" on one edge.
4. Storage of rolls in an upright position on a dry floor is preferred. If long-term outside storage is necessary, the lay-down area should be prepared by placing matting or other material to protect the belt from sharp objects.
5. If long-term storage outside (more than one year) is necessary, the belt must be covered with a suitable material such as a tarpaulin or heavy pigmented plastic sheeting. This will protect the belt from the effects of weathering.

Handling the Roll of Conveyor Belt

1. Conveyor belts should never be dropped while unloading from a freight car, truck or other means of transportation. Due to their weight, dropping rolls can break the packaging and may damage the belt.
2. Belts should never be rolled or skidded. Provisions should be made to use proper moving equipment. Care must be taken when hoisting a conveyor belt to prevent damaging the edges. Insert a bar through the center of the roll and lift with cords or chains attached to a spreader (Fig. 2-1).



3. Once the roll of belting has been transported to the installation area, it should be mounted on a suitable shaft for unrolling and stringing onto the conveyor system.
4. Conveyor belting may be rolled at the factory with the carrying side out or in depending on customer requests.
5. Typically the carry side is rolled at the outside. Consequently, in mounting the roll, the belt must lead off the top of the roll if it is being pulled onto the troughing or carrying idlers but off the bottom of the roll if it is being pulled onto the return idlers. However, if the carry side of the belt is rolled to the inside then the belt will be pulled off in the opposite manner.

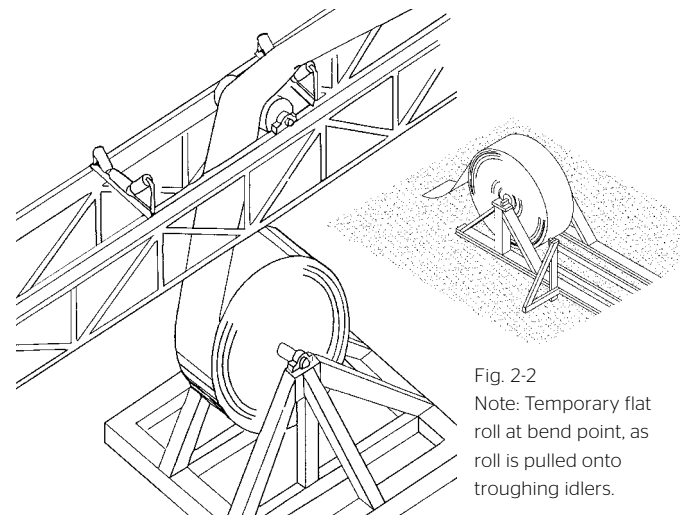

Fig. 2-2
Note: Temporary flat roll at bend point, as roll is pulled onto troughing idlers.

6. Fig. 2-2 illustrates a suitable method of mounting a belt with the carrying side out and leading off the top of the roll when pulling onto the troughing idlers.

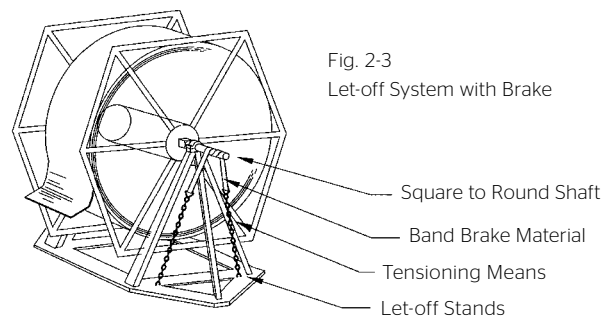

Fig. 2-3
Let-off System with Brake

7. To prevent the belt roll from over-running at the let off, a braking device is recommended (Fig. 2-3).

Stringing the Belt

Textile belts that have been slit from a full width slab at the factory should be spliced with the factory cut edges on the same side of the conveyor. The words "Fact Edge" are painted on the factory edge of slit rolls.

If the Factory Edges cannot be matched to the same side for splicing, one of the slit rolls will need to be re-rolled; such rolls will be identified with "Re-rolled" painted on the belt's edge.

For new installations and major replacements, the following procedure is recommended for belting with Sensor Guard® loops or Cord Guard™ XD Rip Inserts. Each roll of belting will be clearly identified with a roll number.

- ▶ The first end cured at the factory will be attached to the shell.
- ▶ The last end cured in the factory will be the outer wrap.
- ▶ Typically and unless otherwise specified, the top cover will face "outside".

All rolls of belting are to be spliced onto the conveyor in the following sequence starting with the last manufactured roll (e.g. roll #8 of a total of 8).

- ▶ The inside wrap of roll #8 will be spliced to the outside wrap of roll #7.
- ▶ The inside wrap of roll #7 will be spliced to the outside wrap of roll #6 and so on.

After the belt has been positioned, the means of threading it on the conveyor system must be considered. If the new belt is a replacement, the old belt can be used to pull it on. A method to pull belting on the system is as follows: The old belt is clamped off, cut and the new belt then spliced to the end of the old belt using plate type fasteners or pulling plates as illustrated in Fig. 2-4.

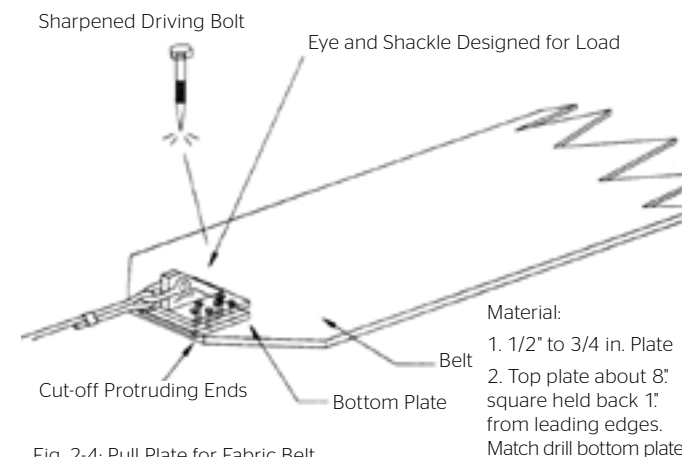

Fig. 2-4: Pull Plate for Fabric Belt

The trailing end of the old belt is connected to a suitable power device to pull the belt through the system. The conveyor drive motor can be used to pull on the new belt. Other suitable pulling devices such as cord winches, belt winders and bulldozers, can also be used. See Fig. 2-5.



Fig. 2-5: Typical belt winder (with snub roll) set-up.

For a new conveyor installation having little or no slope, a rope or cord of suitable strength should be attached to steel pulling plates. The rope or cord is then threaded around the conveyor system and attached to a suitable power device to pull the belt into place.

A belt being installed on a system with a relatively high degree of slope (12 degrees or more) must be handled with more precaution to guard against run-away. The belt roll is set up as previously mentioned, usually at or near the head pulley. This is generally the most accessible. Assuming the conveyor is sufficiently long to require more than one splice, the carrying side and the return side may be threaded on separately. Care must be taken to see that the heavier cover is up on the carrying side and down on the return run.

NOTE: If belts are to be strung on both the carrying and return side of the system, then re-rolling of the belts for one of the sides is necessary before stringing to ensure the correct sequence in splicing. For major installations, rolls can be shipped in this configuration by prearrangement.

As the belt is fed on the system, tension at the roll tends to build up due to the weight of the belt on the slope. For this reason, some method of braking is required, such as using a belt clamp mounted on the conveyor structure, through which the belt is threaded. Where the slope is very long, additional clamps should be used, spaced approximately 1000 feet (305m) apart. Mechanical, air and hydraulic clamps are recommended. Wooden clamping devices are not recommended.

To estimate the pull required to hold a belt on a slope, multiply

If calculating in S.I. units, multiply the belt weight (kg/m) times the vertical lift and add 10%. For example, assume a 60-kg/m belt and a 100 m high slope. The approximate pull is $(60 \times 100) \times 1.1 = 6600\text{kg}$.

If the conveying side and the return side have been fed on separately, the final splice can be made at the bottom of the slope where the ends of the belt meet. In some situations, it is advisable to use a suitable temporary splice to index the belt and complete the final splice at the original location. Making the final splice at the top of the slope is possible but a greater force will be required to remove the sag and lift the counterweight.

Belt clamps must be used on the final pull. The system illustrated in Fig. 2-6 will avoid dismantling the work area by allowing a suitable length of belt to lie back over the clamp.

Tensioning the Belt

Once the belt has been pulled onto the conveyor system, it must be tensioned before splicing to facilitate correct positioning of the take-up and to eliminate sag. The tensioning operation takes place at the location where the last splice will be made. After final tensioning, clamps are placed on each end of the belt. These are made of steel and have a clamping surface as indicated in Fig. 2-6.

Tension is applied by means of a power device which is used to pretension the belt before "clamping off."

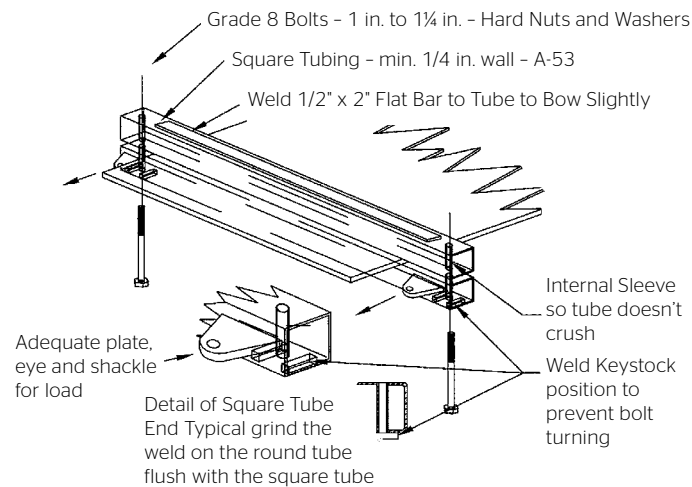

Fig. 2-6: Tension Clamp for Splicing

When tension measuring load cells or scales are used, they are rigged to measure the pull on the take-up pulley. The belt is pulled until the load cell or scales register a tension equal to or slightly greater than the recommended take-up force. Make allowance for an amount of belt necessary to correctly position the counterweight from this point.

Certain basic statements and recommendations can be made about tensioning for splicing:

1. Belts, which are tensioned by pulling in only one direction, require more splicing tension than those pulled in both directions.
2. Belts spliced at the top of the slope require more tension while splicing than those spliced at the bottom.
3. Slope belts having an anti-rollback device, which cannot be released, must be tensioned by pulling in the direction of belt travel only.
4. Check the belt frequently during tensioning to ensure that the belt is free and not binding at any place.
5. During the final tensioning pull, be sure the ends of the belt are lined up properly.



Conveyor installations having limited take-up travel should be spliced to a tension based on the loaded running tension. This tension should be specified by Continental ContiTech, and measured by suitable load cells or dynamometers. Where it is practical, fabric belts should be run for several weeks with mechanical fasteners before making the final vulcanized splice.

Obtaining the required tension depends heavily on the experience of the individual making the splice. It is possible for a gravity-type take-up to damage the conveyor structure if it is positioned too close to the forward or upward stop. Too much tension applied to a relatively short belt may thus have a harmful effect on the pulley shafts and bearings as well as the belt.

Fabric belting is usually installed so that most of the take-up travel is available for subsequent increase in belt length.

The belt may be tensioned with a suitable take-up device as follows:

1. When the counterweight is on: Tie the take-up off 6 in. to 8 in. (150mm to 200mm) above the desired running position. (Consideration may have to be made for excessive sag.) Next, pull the belt until the take-up starts to lift and the tie-off ropes become slack. Make the final splice allowing a minimum of belt slack.

2. When the counterweight is not on: Splicing without the counterweight installed is undesirable, however the following procedure should be employed if necessary. Use suitable belt clamps to hold the take-up pulley 6" to 8" (150mm to 200mm) above the desired running position. (Consideration may have to be made for excessive sag.) Pull the belt to its running tension, which can only be estimated in this situation. Judgment in estimating this tension will improve with the experience of the splicer.

Take-Up Travel and Initial Position

Tables 2-1 and 2-2 show the recommended minimum take-up travel and initial take-up position, respectively.

Table 2-1 Recommended Minimum Take-Up Travel In Percent Of Center Distance

Type Of Take-Up And Carcass Material (Warp)	Percent Of Rated Tension		
	100%	75%	50%
Manual Take-Up			
Nylon	4.0%	3.0%	2.0%
Polyester	2.5%	2.0%	1.5%
Aramid	2.0%	1.5%	1.0%
Fiberglass	1.0%	0.75%	0.5%
Automatic Take-Up			
Nylon	3.0%	2.50%	1.50%
Polyester	1.7%	1.25%	0.75%
Aramid	1.5%	1.0%	0.75%
Fiberglass	0.5%	0.4%	0.25%
Steel	0.3%	0.23%	0.15%

- › This table is a general guideline. See individual product brochure for more specific data.
- › Take-up location position per Table 2-2.

- › Drive location at or near the high-tension end of the conveyor.
- › Only short feeder belts and similar would normally be vulcanized on conveyors with a manual take-up.

Table 2-2 Recommended Initial Take-Up Position +

Carcass Material (Warp)	Percent Available For Length Increase	Percent Available For Length Decrease
Steel	25%	20%



Call Toll Free: 1-866-711-4673
International: +1-727-342-5086



Cutting the Belt to Length

1. When splicing a belt to a specified length or a net endless length (NEL), the following total length of belt will be required: The specified NEL length plus the bias length, plus one splice length, plus a minimum of 2 in. (50mm) trim allowance. If two or more belt rolls are to be spliced NEL, add a splice length plus a minimum of 2 in. (50mm) trim for each roll or splice.
 2. When replacing a damaged section of belt the required length of new belt will be: The length of the damaged section plus 2 splice lengths, plus a minimum of 4 in. (100 mm) trim allowance. Cut the ends square.
- NOTE: Whenever a section of new belt is to be spliced into an old belt the length of old belt to be removed should include as many of the old splices as is reasonably possible.
3. On very short conveyors, it is sometimes necessary to remove the tail pulley in order to have adequate slack for splicing after cutting to length.
 4. When a splice has to be done on the return run, precautions must be used in measuring the belt length. The splice area may be located on the ground requiring an adjustment in belt length, if the conveyor is elevated above ground level.

5. In most cases, it is not possible to pull up and use the entire belt that appears to be available in a take-up. About 4 ft. (1.2m) of belt will be needed for slack in splicing. In other words, for a re-splice the take-up should have at least a splice length plus 4 ft. (1.2m) available for removal.
6. If a fabric splice is to be remade and there is very little belt in the take-up, the old splice can be cut parallel to the bias and near the center. The old splice area is then re-stepped and re-spliced and the take-up is only raised half of the total length of the steps on one end of the splice.
7. Belts running on 45° idlers on a system with a minimum take-up should be clamped off at or near the head pulley. Tension the belt with a center pulling plate so the belt will conform to the idlers when pulled and then mark master line on each end. Leave minimum slack for the vulcanizer.

CAUTION: TURNS: THE CONVEYOR PROFILE MUST BE CONSIDERED WHEN STRINGING THE BELT TO PREVENT THE FINAL ORIENTATION FROM BEING UPSIDE DOWN. FOR EXAMPLE, TURNS ADD A TWIST TO THE BELT THAT MUST BE ANTICIPATED. CONTINENTAL CONTITECH RECOMMENDS TURNING THE BELT 180° AT THE HEAD AND REVERSED 180° AT THE TAIL. SEE FIG. 2-7 FOR A TYPICAL TURNOVER DESIGN.

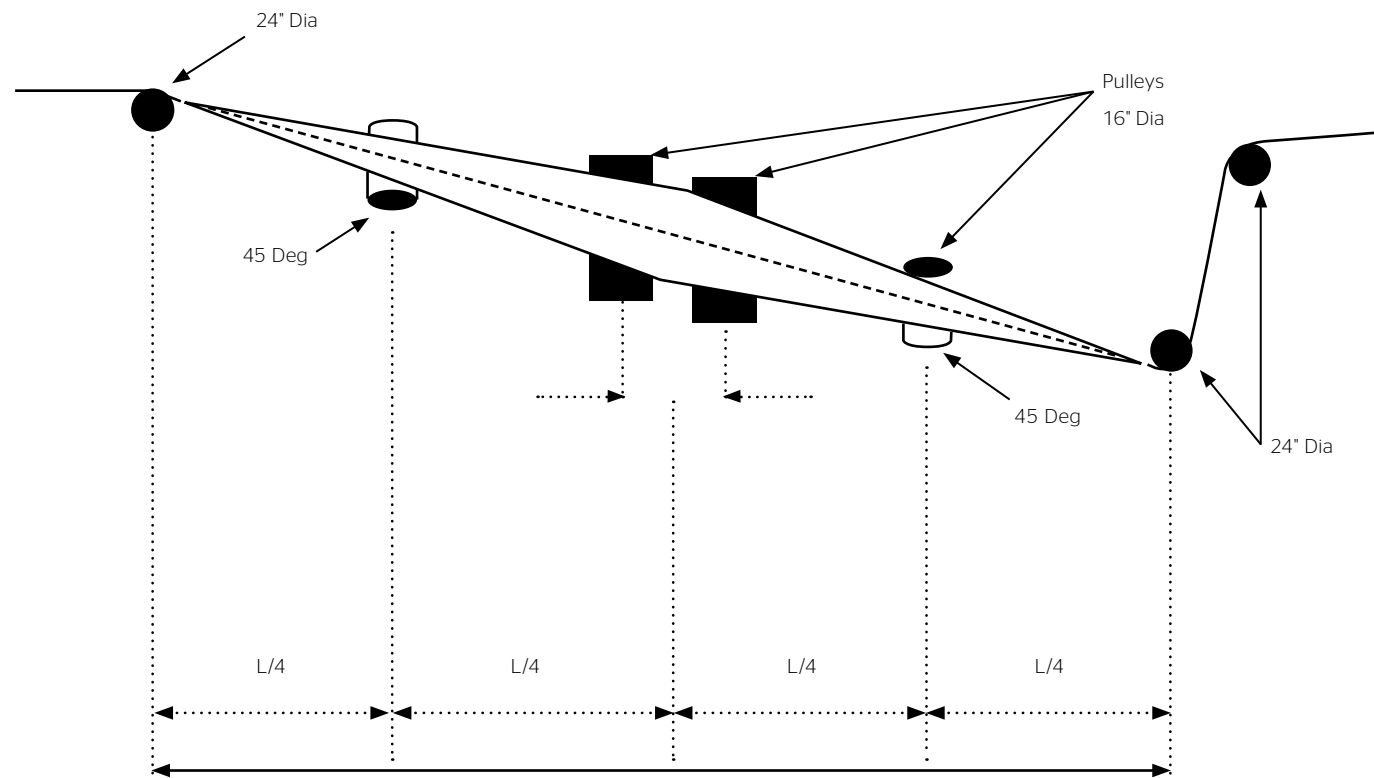

III. Fabric Splice Preparation

General

First one must verify the type of splice required for the belt being spliced.

Preparation of Work Area

1. Preparation of the work area is one of the most critical items while performing any splice. Care should be taken during the selection of the work area with due regard to safety and ease of egress.
2. Often, time "saved" during the set-up of the work area is lost due to poor splice quality associated with misalignment, cluttered working areas, or unsafe working areas.
3. Selecting the best working area and scheduling the necessary time to set up and prepare the area will often result in better workmanship.

Location for Splice Work

1. On incline or decline belts, it is desirable to work at the lower end if possible. Splices can be made at the upper end, but high belt tensions can cause difficulties in restraining the belt with clamping devices.
2. At the upper end, there is a risk of the belt breaking away from the clamps and running loose down the slope.
3. Level belts may be spliced at any location where power is available and it is convenient to set up the equipment.
4. The location must have facilities for hoisting the vulcanizer or other heavy equipment and placing them in the desired positions.
5. The locations must be long enough and wide enough to accommodate the necessary work area and shelter. See Shelter For Work Area below.
6. One must account for the weight of splicing, personnel and ancillary equipment if the splicing is to be completed on the conveyor structure.
7. When splicing at elevated areas, it may be required to wear a safety harness to prevent accidental falls.

Shelter for Work Area

1. A shelter must be constructed over the splice area to keep the belt ends clean and dry at all times.

4. The size of the shelter depends on the width and construction of the belt to be spliced. Generally it should be 4 ft. to 6 ft. (1.2m to 2.0m) wider than the belt, 12 to 18 ft. (3.6m to 5.5m) longer than the splice and have 8 ft. (2.4m) or more between roof and the work table.
5. As a rule of thumb, 4.5 times the splice length is a good starting point.
6. The splicing company is typically responsible for constructing the shelter and maintaining a clean and contaminant-free splice.
7. If a permanent building is not available, then a temporary shelter must be built to protect the exposed belt ends from adverse weather conditions, dust, and all other forms of contamination.

Temperature and Humidity for the Work Shelter

1. It is recommended that the temperature in the work area be maintained at 60°F (16°C) or greater.
2. It is also recommended that the relative humidity be less than 75%.
3. This is to ensure that the rubber materials to be handled will be both tacky and flexible.
4. In hot, humid conditions this will also help to prevent condensation while maintaining equal drying time for surfaces coated with the specified cement and/or solvent.
5. These guidelines are to ensure the splice rubber materials remain tacky and flexible. Controlling the humidity in the splice shelter may be difficult or impossible at times.
6. Avoid condensation of the cements and splicing rubber.
7. When splicing during colder weather, allow the cements and splicing rubber to warm beyond the possible condensation state.
8. When splicing during extreme hot ambient temperatures, avoid handling/touching the open belt ends, the exposed fabric carcass and splicing materials with bare hands as sweat and/or oils may transfer and contaminate the fabric carcass and splicing materials.
9. Avoid all types of moisture such as rain, water, sweat or other non-specified liquids from contacting the open belt ends, the exposed fabric carcass and splicing materials.
10. Open-flame torpedo-style kerosene heaters are not recommended due to explosive hazards and potential contamination by residual kerosene in the splice area.
11. Maintain a clean and orderly shelter. Never walk on belt where covers have been removed or fabric is exposed.

The Work Table

1. Laying out the splice and cutting of the plies must be done on a flat, smooth surface. The bottom platen of the vulcanizer is used as the center section of the work area.
2. The work area surface should be 6 in. (150mm) wider than the belt being spliced and at least 4 ft. (1.2m) longer than the splice. The surface should be one piece or smoothly joined and firmly held in position. Plywood with a thickness of 5/8 in. - 3/4 in. (15mm - 19mm) is usually sufficient.
3. The table must be elevated to provide clearance for clamps used to hold the belt ends in alignment.

Splice Tools

It is strongly recommended to use the correct splicing tool needed to perform specific tasks. One very important tool is the Fabric Ply Knives. The Fabric Ply Knives are designed to cut at a given depth and prevent cutting or damaging the adjacent plies.

Fabric Ply Knives

1. Typically there are two types of ply knives used to accurately cut plies without damaging/nicking the adjacent ply.
 - › The 0.040 ply knife is generally used for the lighter weight fabrics up to and including 150#.
 - › The 0.080 is generally used for heavier weight fabrics such as 200# & 250#. For fabrics such as 400# - 450# and greater, hook knives are typically used.
2. Do not attempt to sharpen these knives. Sharpening them will increase the hook depth and may result in damaging the adjacent ply.
3. The "One-Ply" knife, as the name implies, is intended to cut only one ply. Therefore, certain points should be carefully observed.
4. The depth of the cutting edge should be sharp and approximately 75% of the thickness of one ply of the fabric being cut. Various weights and types of fabric require different depths of the cutting edge (Fig. 3-1).

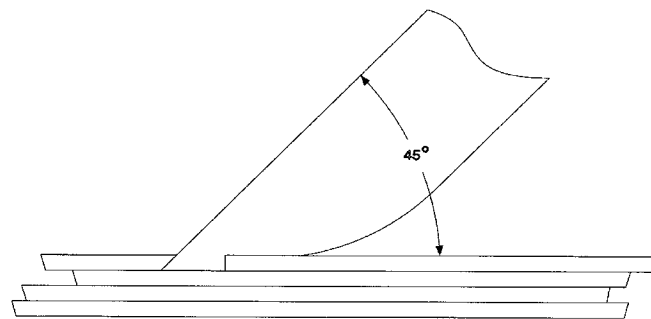

6. Practice sessions using the ply knives are recommended.

CAUTION : A high percentage of fabric splice failures are caused by the one-ply knife nicking, cutting or gouging the adjacent ply.

Inspect one-ply knives frequently and see that the hook or cutting edge is not too deep. Regardless of the condition of the knife, it is possible to cut through more than one ply and the operator should always watch this closely. Keeping the knives in proper condition is important.

Never cut deeper than intended, or cut into or destroy any fabric, which is to remain a part of the splice.

Mill Knives with Dull Rounded Tips and Sharp Cutting Edge

These knives are used to cut through the cover rubber without damaging/nicking the adjacent ply.

Adjustable Olfa Knives or Box Knives

1. These knives typically have razor-sharp tips and edges and can cut into adjacent plies very easily.
2. These knives should not be used or take the place of the ply knives to step down fabric splices.

Prodders:

1. Prodders are used to separate the inside rubber from the stationary fabric ply. The prodding tool must be dull, rounded and smooth. Burrs and/or nicks on the tip will cause damage to the fabric ply. The care and handling of the ply lifter/prodder is important.
2. The corners should be rounded. Approx. 1/8 in. (3mm) radius is recommended. Sharp corners will injure the ply beneath the one being loosened (Fig. 3-2).
3. After considerable use, the edge at the end or tip of the prodder (Fig. 3-2) will become worn and sharp. This should be kept dull, rounded and free from burrs.
4. Use the ply lifter/prodder so that it is parallel to the cut and held at an approximate 30° angle from the belt. The flat end or tip of the ply lifter should also be at about a 30° angle from the belt. In this manner, it will loosen the edge of the fabric without "digging into" or injuring the next ply (Fig. 3-3).

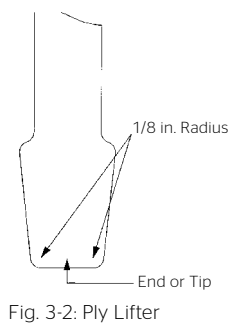

Fig. 3-2: Ply Lifter



Fig. 3-3: Improper care and use of the ply lifter may also damage the adjacent ply and may

Porcupine Roller and Stitch Rollers

The porcupine roller and stitch rollers are used to roll rubber sheet flat and remove possible trapped air.

Identification

1. Tools identified below are typical splicing hand tools. Always use the proper tool for the job.
2. Use the proper PPE and handling/application safety procedures

Miscellaneous Items

1. A winch/tugger will greatly reduce the time spent stripping the belt ends.
2. Power is a prerequisite when tearing down fabric reinforced belt ends. An air or electric winch is typically used.
3. Water, for cooling the vulcanizer.
4. Appropriate power supply to operate electric buffers, tuggers, etc.
5. Thermocouple unit and pressure transducer with chart recorder.
6. Required personal safety equipment.

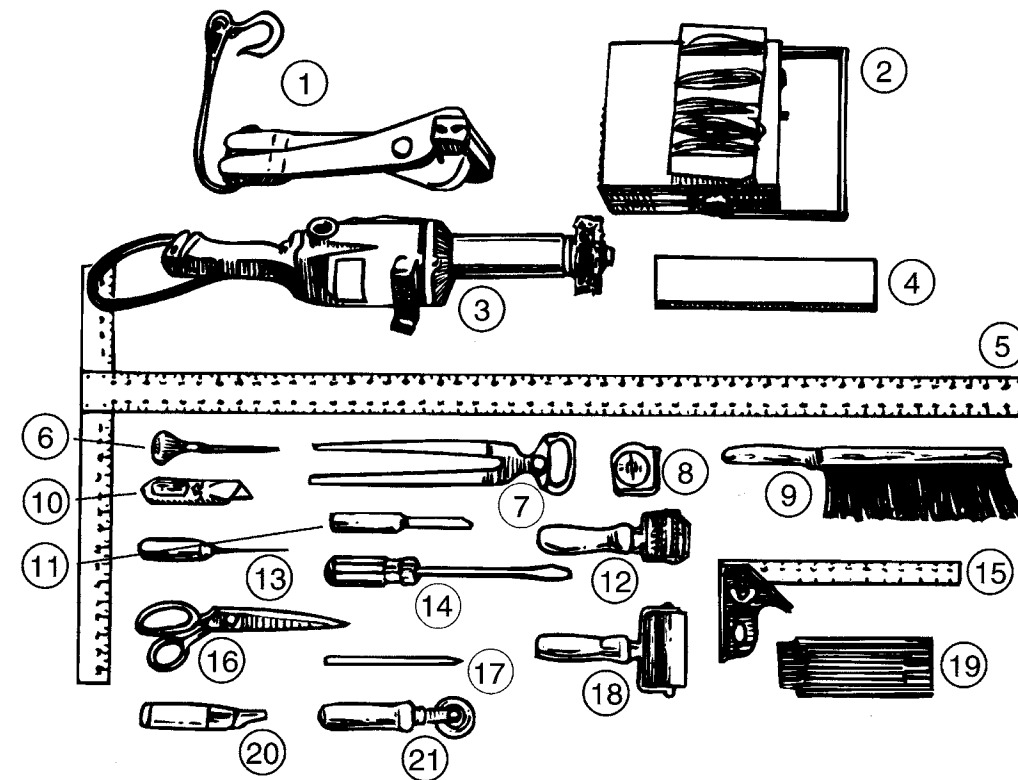

Fig. 3-4: Fabric Belt Splicing Tools.

1. Rubber and fabric pulling device
2. Thermocouple unit and wires
3. Buffer
4. Sharpening Stone
5. Square
6. Awl
7. Ply lifting clamp
8. Tape
9. Foxtail brush
10. Stanley knife
11. One-ply knife
12. Pricker roll
13. Flexible skiving knife
14. Ply prodder
15. Small square
16. Scissors
17. Silver pen
18. 4" roller
19. Folding ruler
20. Dull and rounded knife
21. 1/16 in. stitcher

Direction of Splice and Bias

1. In most level or inclined (power-requiring) belts, it is recommended that the belt ends be stepped down so that the pulley side joint leads and the top side joint trails the direction of belt travel (Fig. 3-5).

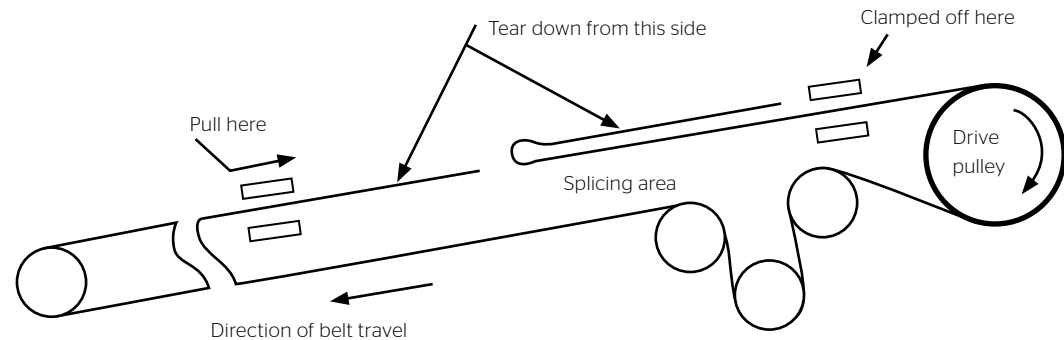

Fig. 3-5: Splice Direction - Incline (Power-requiring)

2. In most decline (regenerative) belts, the splice is prepared according to Fig. 3-6 so that the pulley side joint trails and the top side joint leads the direction of belt travel.

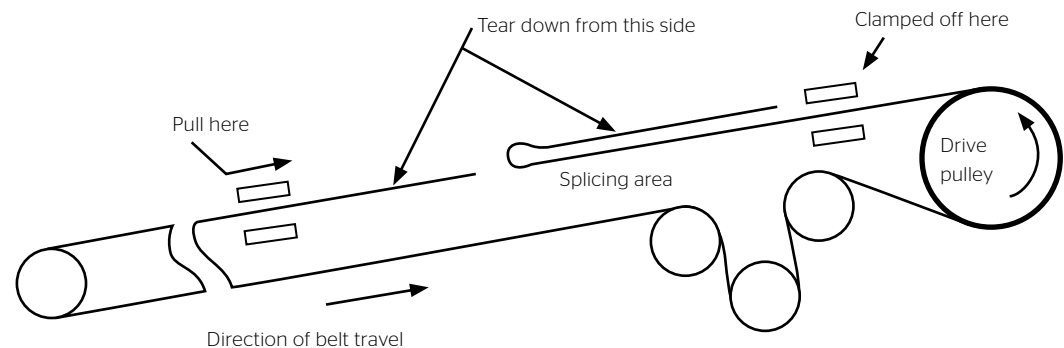

Fig. 3-6 Splice Direction - Decline (Regenerative) Belts

3. An exception to the above splice directions sometimes occurs when splicing a new belt into an old one.
4. If the old belt covers are badly worn, then both ends of the new section should be stepped down from the pulley side. This leaves new unworn top cover on both splices and will provide more uniform vulcanizer pressure. In doing this, one splice will run in reverse to the usual recommendation.
5. Be sure that the bias direction will conform to that of the vulcanizer and that the entire cover insert can fit within one setting of the vulcanizer.
6. Slight adjustments of 1 in. to 3 in. (25mm to 75mm) of the bias angle are permissible if necessary.

Existing Splices Loaded onto a Conveyor System

Splices made prior to installing the belt onto the conveyor system must be clearly marked/identified so the installation crew can identify the direction of travel.

Establishing a Master Line

1. The master line is normally the first mark to be made on each of the two ends to be spliced.

DOT - Direction Of Travel: Bottom Fill Leads Direction Of Travel

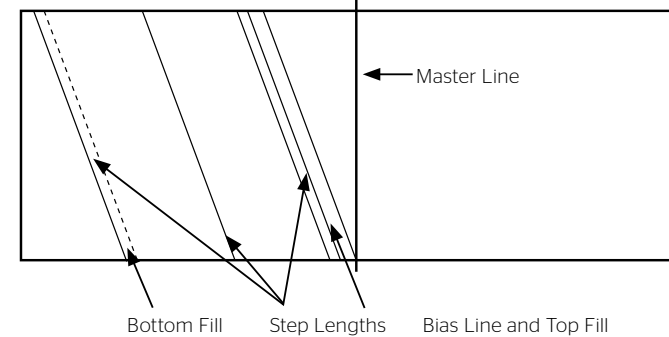
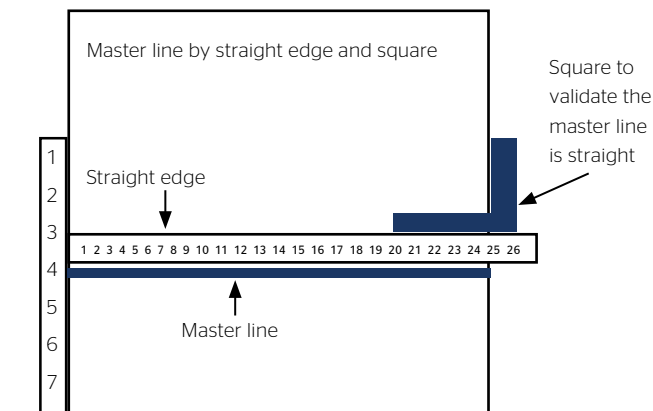

Fig. 3-7

2. A true master line will ensure the splices are at a minimum started off square. The mark is drawn straight across the belt's width at a distance equal to the total splice length plus trim allowance from the belt end.
3. Three methods of locating and squaring the master line are as follows:

Square and Straight Edge (Fig. 3-8)

1. Check the master line by laying the square along the opposite edge. As a final check, mark off the bias lengths on each edge and check that the two diagonal lengths are equal.



2. From the end of the belt, measure back the length of splice plus trim allowance.
3. Use a square and straight edge to draw master line.
4. To prepare the second (opposite) belt end, fold the belt back and repeat the procedure. Make sure that the bias is on the opposite edge on the other end.

Triangulation (Fig. 3-9)

1. From the end of the belt, measure back along one edge the splice length plus trim allowance. Mark the edge. This mark is then the center point of a line exactly 4 ft. (1200mm) long drawn along this edge.
2. From each end of the 4 ft. (1200mm) line measure equal diagonal lengths to the opposite edge and mark (Fig. 3-9). Draw the master line.
3. This method is common on belts 72 in. (1,800mm) and wider.

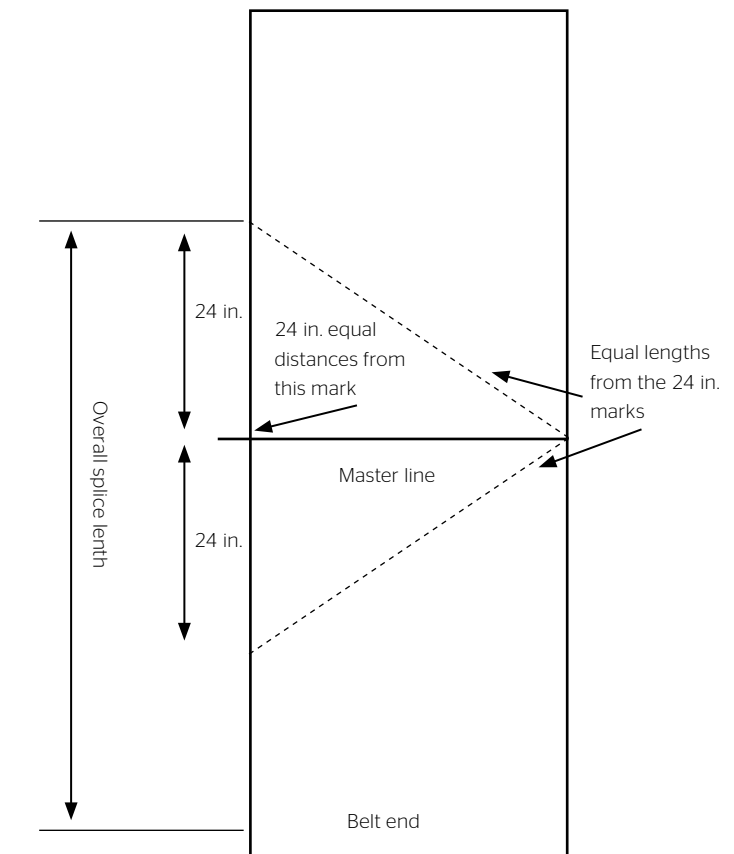

Fig. 3-9: Triangulation Method

Swinging Arc (Fig. 3-10)

1. Carefully mark a point at the exact center of the belt width.

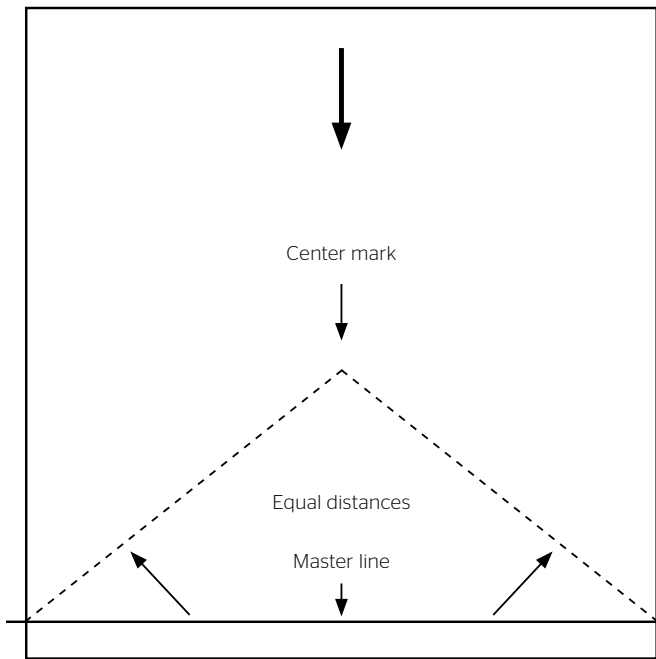

Fig 3-10: Swinging Arc Method

Establishing a Center Line (Fig. 3-11)

1. Center-lining the belt ends is necessary to ensure a properly aligned splice.
2. Place the belt ends on the bottom platens so that the distance between the top of the 45° cover skives equals the splice length.
3. The center of the splice should be positioned on the center of the bottom platen (both length and width).
4. The press platens must be **a minimum of four inches longer and wider than the completed splice.**
5. On each belt end mark four evenly spaced center locations from the 45° cover skives to the end of the work table.
6. Extend a string from the marks at the outside ends of each work table, supported by a suitable block to keep the string free from interference by the belt surface.
7. Use a square to align these end marks to the string.
8. Check the remaining center marks and adjust the belt as necessary until all marks are aligned.
9. Verify the splice length distance between the 45° cover skives.
10. Secure the belt ends in this position. Typically C-clamps are used to secure the belt to the work table.

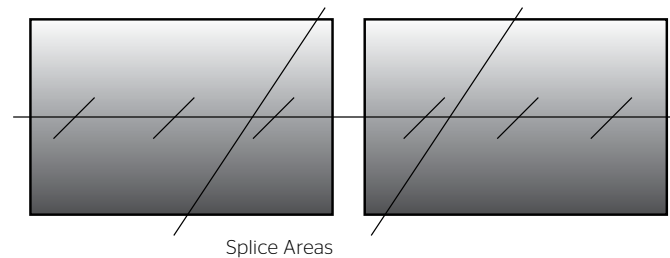

Fig. 3-11

Dry Fit Splice Alignment

1. Once the center line procedure is satisfactorily completed and the belt ends are firmly clamped stationary, it is necessary to verify the alignment of each ply seam/joint before building the splice.
2. The ply seams/joints must have a 1/16 in. gap approximately.
3. Ply seams must not be butted or overlapped.
4. Carefully trim the ply seams if needed. Use caution not to damage adjacent plies.

Addressing Belts with Damaged Edge(s)

1. When belt edges are damaged it is necessary to establish a master line on one end only by one of the above methods and proceed to step that end down.
2. Lay the ends together, align by eye as well as possible, and transfer all marks to the second end.

Addressing Belts with Unequal Widths (Fig. 3-12)

1. If the two belt ends are not the same width then the wide end is to have bias and step points marked along the edges in the normal manner.
2. Then measure in from these marks at right angles to the edge a distance half the width difference and make marks.
3. Connect these new marks for correct bias and step lines.

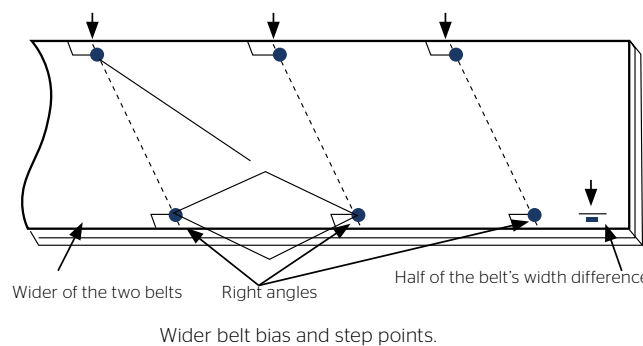

Fig. 3-12: Addressing Belts with Unequal Widths

IV. Vulcanizing

Cure Time and Temperature

Follow the belt manufacturer's specified/recommended curing rules. Using the correct time and temperature will ensure the ultimate cure for the splice rubber. Altering or changing the cure time and/or cure temperature may jeopardize the integrity of the splice.

The cure time and temperature shall be monitored and documented at defined intervals throughout the splice cure and cool down. Use thermocouples to accurately monitor the core temperature. Control the platen temperatures to achieve the specified cure temperature by adjusting the set points on the power control box. The temperature reading displayed on the thermocouple is the accurate cure temperature during the cure cycle. Use a minimum of one thermocouple per heating element.

Pressure

The use of a field vulcanizer with a bladder(s) to apply pressure to the entire platen surface is preferred because of its uniform pressure distribution (Fig. 4-1). If multiple bladders are used, they must be connected to a common manifold to ensure equal pressure in all bladders.

Other types of pressure systems on field vulcanizers are acceptable if they are capable of meeting a tolerance of +/- 5% over the curing area of the platen. During the cure cycle on bladder presses, pressure should be monitored using a transducer connected to a suitable recording device.

1. Follow operating and safety procedures recommended by the vulcanizer manufacturer.
2. Use care if pressure is applied while the vulcanizer is still cold. Platens can expand when heated causing extreme pressures, which may damage the vulcanizer.
3. To obtain edge pressure, use steel guides along each edge which are approximately 1/32 in. - 1/16 in. (0.8mm - 1.6mm) less than belt thickness. The guides should be drawn together against the edges as uniformly as possible with ratchet chain type or cord type come-along. These come-alongs should be only drawn up snug initially. Then, after the vulcanizer pressure is applied, they should be drawn tight.
4. Use of wedges against the edge irons in the splice area will limit bowing.
5. The recommended vulcanizer pressure for fabric belts is 100-130 psi (.69 - .89 MPa), however precautions should be taken NOT to exceed the vulcanizer manufacturer's maximum pressure.

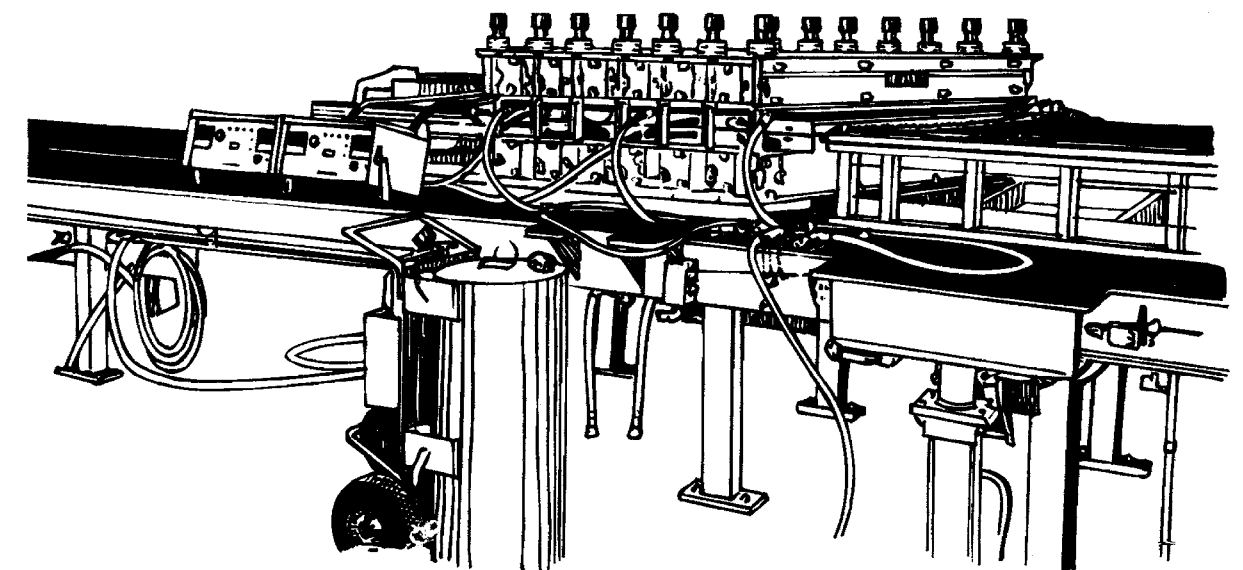

Fig. 4-1

Power Failure: 50% Rule

In case of a power failure while curing, do not release the pressure, but hold it until power is restored and then bring the vulcanizer back up to cure temperature. At that time:

1. If the splice had less than half of its specified cure time before power failure, repeat the entire specified cure time. If the splice had cured half or more of the specified time, then finish curing the remaining time after all thermocouples again register the specified temperature.
2. Someone must be monitoring and documenting the cure cycle of the splice. This person must know and be able to react if necessary to perform the 50% rule procedure.

Pressure Failure

If vulcanizing pressure is lost on the surface of the splice, it must be remade. It is not recommended to use the same sections of the belt ends to re-splice. It is strongly recommended to remove the sections of the splice that experienced loss of pressure.

Vulcanizing the Splice

Careful preparation has been completed to build the splice according to the manufacturer's specifications and recommendations. The same detail must be applied to curing the splice.

The goal is to achieve ultimate cure of the splice rubber. The vulcanization of rubber compounds needs to be carefully controlled and monitored to ensure optimum rubber properties for maximum splice life. Ultimate Rubber Cure is a result of controlled time and temperature. Curing at a higher than specified temperature or altering the cure time may jeopardize the possibility of achieving Ultimate Rubber Cure. Within the splice it is critical to allow the rubber to work/perform as it is designed.

Vulcanization, as a rule of thumb, doubles in the rate of cure for every 18°F (-7.7°C) change in temperature. Over-curing, a splice can be as detrimental as under-curing. Temperature controllers and measuring devices on vulcanizing equipment should not be relied upon to provide a dependable assessment of the actual platen temperatures. For this reason, each individual heating element in a platen must be monitored with a thermocouple placed on the surface of the belt. A properly calibrated thermocouple unit connected to a chart recorder or other suitable data acquisition unit is required.

During a cure, it is the responsibility of a member of the splice crew to observe the temperatures of each thermocouple and continually adjust the press control units to maintain temperatures within 0° to 5°F (-17.7 to -15°C).

It is recommended that all field vulcanizers temperature

1. Cure times and temperatures are shown on Table 4-1.
2. The timing of a splice cure is not to start until all thermocouple readings have reached the specified temperature.
3. It is recommended to use a splice shelter or tarpaulin over the vulcanizer/splice area to keep the splice dry, minimize heat loss, and promote uniform heating in windy and cool conditions.
4. Due to heat radiation, the splice and belt ends must be centered on the bottom platen. The splice and belt ends must be 3 in. - 4 in. (75mm - 100mm) inside the platen edges.
5. The splice must not be put into service until it has cooled to 130°F (54.4°C) or lower.

Belt Thickness (mm)	Inches	Fabric Belt Cure Time (min)
up to 3.1	up to 1/8	20
3.1 - 6.3	1/8 - 1/4	25
6.3 - 9.5	1/4 - 3/8	25
9.5 - 12.7	3/8 - 1/2	30
12.7 - 15.8	1/2 - 5/8	35
15.8 - 19.0	5/8 - 3/4	35
19.0 - 22.2	3/4 - 7/8	40
22.2 - 25.4	7/8 - 1	45
Add 5 min. for Neoprene Belts over 1" Gauge (25.4mm)		
25.4 - 28.5	1 - 1 1/8	50
28.5 - 31.7	1 1/8 - 1 1/4	50
31.7 - 34.9	1 1/4 - 1 3/8	55
34.9 - 38.1	1 3/8 - 1 1/2	60
38.1 - 41.2	1 1/2 - 1 5/8	60
41.2 - 44.4	1 5/8 - 1 3/4	65

Table 4-1: Fabric Belt Cure Pressure is 100 psi - 130 psi (.69 - .89 MPa).

Press Platen Cooling

To prevent blistering, the vulcanizer should be cooled to 130°F (55°C) or less, before releasing pressure. This is a good practice at all times since unexpected blisters are undesirable and require repair or sometimes a complete remake of the splice.

After the splice is cured, remove release material. If Holland cloth is used, a water soak may be necessary. Trim and/or buff the overflow at the edges. Do not leave the belt on a hot vulcanizer.

When Without Platen Cooling

It is not recommended to use a vulcanizer that does not have cooling capabilities. Leaving a splice in a hot vulcanizer while it cools without the aid of flushing water or air will result in over-curing the splice rubber. Overcooked splice rubber is a leading cause of premature splice failures. Overcooked splice rubber will not perform as well as splice rubber that has achieved Ultimate Cure.

1. This section is included only to address those rare instances where the vulcanizer is not fitted for water cooling ports.
2. At the completion of the specified cure time, TURN OFF THE HEATING ELEMENTS, RELEASE THE PRESSURE AND REMOVE THE TOP PLATEN IMMEDIATELY. This procedure is necessary to avoid over curing the splice.
3. DO NOT ALLOW THE BELT TO REST ON THE HOT BOTTOM PLATEN. Either remove the bottom of the press or carefully elevate the belt to provide an air space for cooling. Lift the belt from the press using a support bar at each end of the splice.
4. Proceed on to Splice Completion.

Splice Completion

After the cure cycle is finished and cooling the press has been completed:

1. Remove the top platen of the vulcanizer.
2. Remove edge guides and fill steel.
3. Remove top thermocouple wires.
4. Remove release paper.
5. Inspect the splice for any abnormality such as blisters, ply blows, gum blows, porosity etc.
6. Repair and document any abnormality seen.

7. Buff the overflow at the fill strip area. Buff in the direction from the fill strip into the belt. Buff and remove the rubber overflow until a flat, smooth transition from the belt to the splice is achieved.
8. Perform the same inspection and buffing on the bottom fill strip area.
9. Remove all vulcanizing tools, equipment and materials. Properly dispose of all trash and leftover splice materials.

General Curing Notes

1. The area between the steel guides and the outside edge of the vulcanizer should be filled to avoid possible platen distortion or damage. Steel or aluminum guides may be evenly spaced approximately 6 in. to 10 in. (152mm - 254mm) apart.
2. To help release steam on an obviously wet belt, an awl should be used to perforate the belt every 2 in. - 4 in. (50mm - 100mm) along the vulcanizer ends.
3. Though not recommended there are instances when the vulcanizer dimensions are such that a splice will be cured in two or more heats.

In these cases:

- Begin at one end of the splice.
 - The cover (fill-in) strips should be completely cured in a single heat.
4. The bias length is sometimes adjusted (a few inches) so the full splice length can fit in the vulcanizer and be cured in one cook cycle.
 5. The bottom platen must be 6 in. to 8 in. (152mm to 203mm) wider and longer than the splice. Center the splice on the bottom platen making certain there is approximately 3 in. to 4 in. (75mm to 100mm) of platen extending past its edges and ends.

V. Belt Splicing Procedures

Fabric Belt Bias Step Splice

Splice Dimensions

Specified splice dimensions for the various splice types are documented in the Heavyweight Conveyor Belt Catalog and on the specified splice schematic.

Splice Bias

1. The bias is a critical part of the splice and is typically designed to match the bias of most vulcanizers.
2. The entire Top and Bottom Insert Rubber Strip must be cured in a single setting of the vulcanizer. When needed, to cure the splice in a single cook, the bias length may be adjusted/shortened. The recommended bias lengths are shown in the splice schematics, but they can be adjusted up to 2 in. or 3 in. (50mm or 75mm) if necessary to accommodate the vulcanizer.

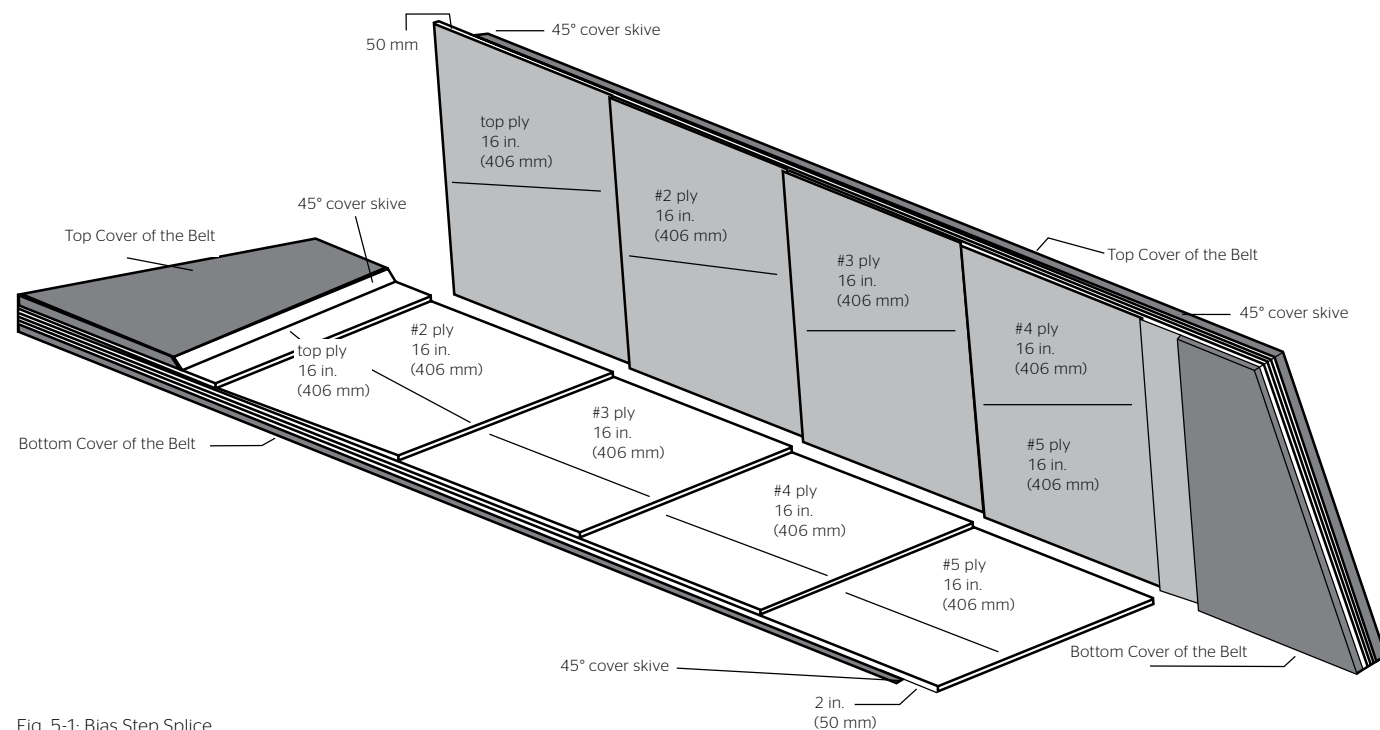

Fig. 5-1: Bias Step Splice

NOTE: Bias can be made to match the bias on the vulcanizer. The most common are 20° and 22°. The 22° bias angle can be achieved by multiplying the belt width by 0.40. A shorter 20° bias angle can be achieved by multiplying the belt width by 0.36.

An example of the 22° bias angle is: 72 in. belt width x 0.40 = 28.8 in. (round to 29 in.) bias. An example of the 20° bias angle is: 72 in. belt width x 0.36 = 26 in..

3. The Bias Step Splice is not currently recommended for the heavier carcass belts with fabric plies greater than 250#. These fabric/belt types require the Full Carcass Long Life Finger Splice method. The Full Carcass Long Life Finger Splice method allows for better flexibility in the splice as the belt travels around pulleys while under great tensions. Belts such as Fortress XP™ and Pylon® Plus (900/2, 1350/3, 1500/3 and 1800/4) require the Long Life Full Carcass Finger Splice.

Procedures

1. The illustration Fig. 5-1 below shows the Bias Step Splice and how the plies from each belt end are stepped down and aligned to make the splice.

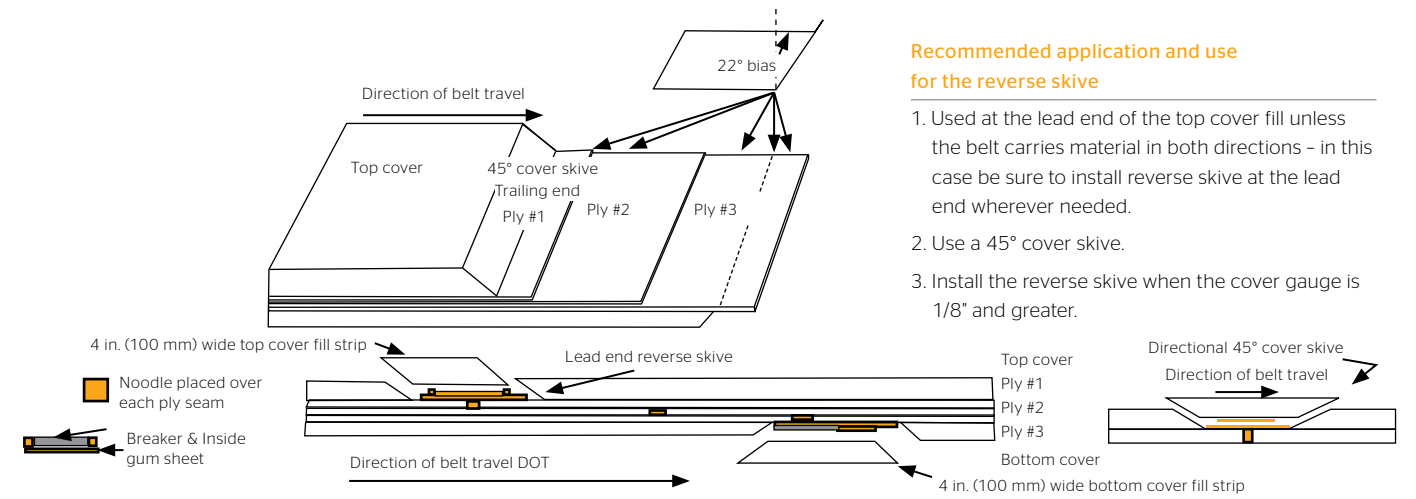
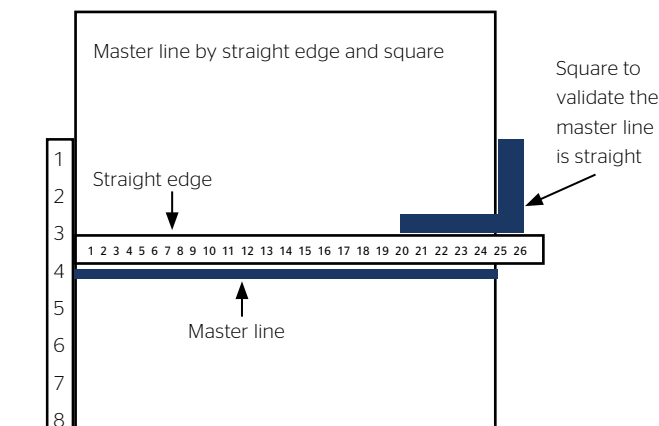

Fig. 5-2: Three Ply Splice

Recommended application and use for the reverse skive

1. Used at the lead end of the top cover fill unless the belt carries material in both directions - in this case be sure to install reverse skive at the lead end wherever needed.
2. Use a 45° cover skive.
3. Install the reverse skive when the cover gauge is 1/8" and greater.

2. Illustration Fig. 5-2 shows a schematic of the typical Three Ply Splice.
3. The technique for splicing fabric belts using the Bias Step Splice method is essentially the same for any number of plies. A four-ply construction is illustrated in the sketches and instructions that follow.
4. Draw the master line.
 - a. A square and straight edge is generally used to mark the master line on the belt as described in section III of this manual.
 - b. After checking both edges, if there is a difference in belt width, it can be halved and the result will usually give an accurate line.
 - c. Check the master line by laying the square along the opposite edge. As a final check, mark off the bias lengths on each edge and check that the two diagonal lengths are equal. Refer to Fig. 5-3.



5. Measure off the bias length and draw the bias line to the end of the master line on the opposite edge (Fig. 5-4). This line marks the location of the top ply cut after the cover gum is removed.

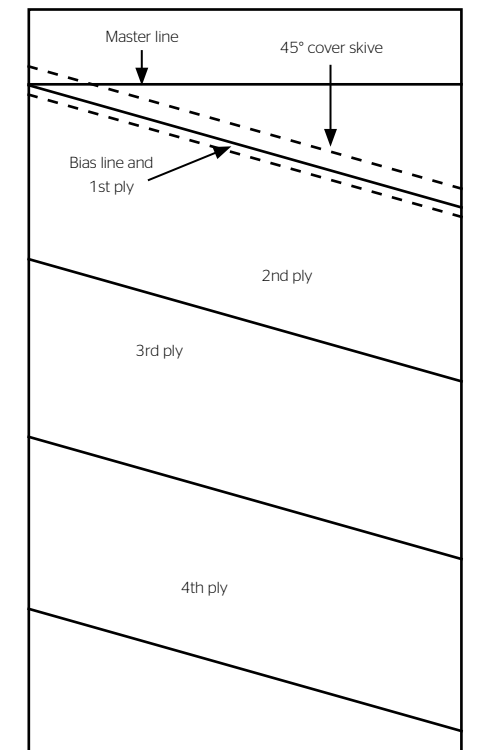

Fig. 5-4: Drawing the bias line

6. Measure the splice length, plus 1 in. (25mm) trim starting from the end of the belt (Fig. 5-5).

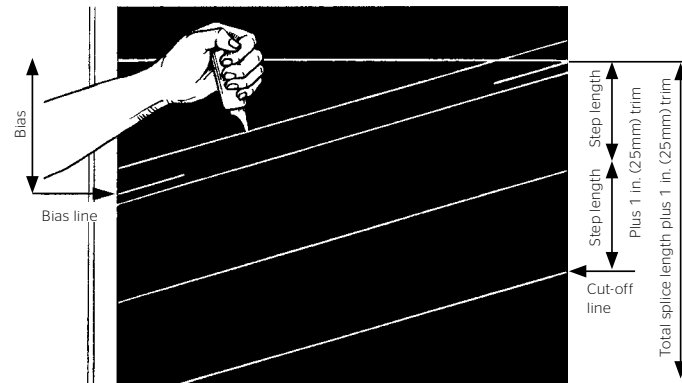

Fig. 5-5: End of belt

7. Measure off the bias length and draw the bias line to the end of the master line on the opposite edge (Fig. 5-6). This line marks the location of the top ply cut after the cover gum is removed.

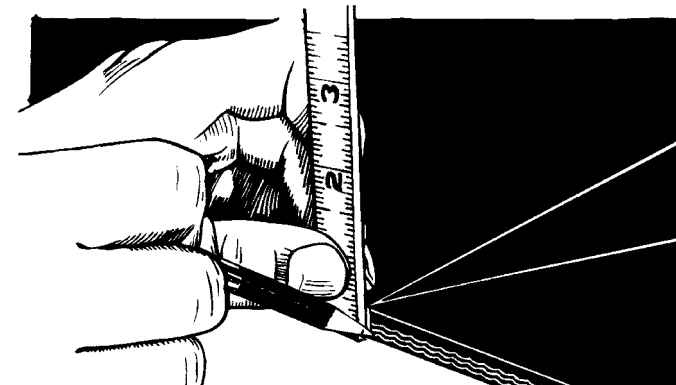

Fig. 5-6: Marking the ply cuts down the edge of the belt.

8. Extend the end of the bias line down over the belt edge.
9. From the bias line measure toward the end of the belt a distance equal to the total number of steps plus 1 in. (25mm) trim for example:
 A 2-ply fabric belt requiring 8 in. (203mm) steps would equal 9 in. (230mm)
 3 ply = 17 in. (430mm)
 4 ply = 25 in. (635mm), etc. Mark the cut-off line, which is parallel to the bias line (Fig. 5-5).
10. Lay out the cover strip for removal. Draw one line parallel to and approximately 1/2 in. (13mm) from the bias line and on the splice side. Draw a second line on the belt side of the bias line but at a distance of 2 in. (50mm) (Fig. 5-7)

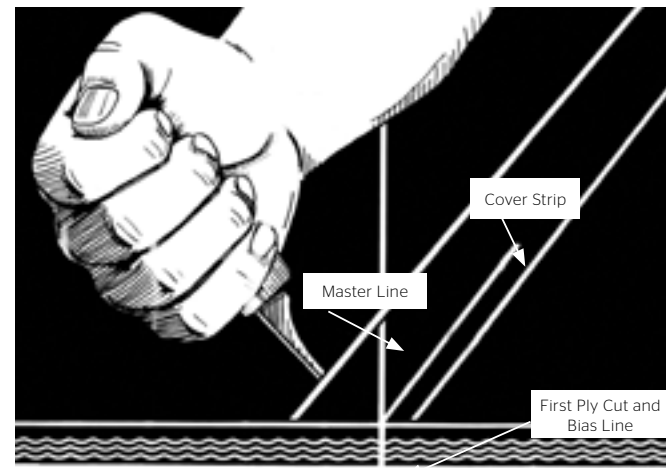

Fig. 5-7: Showing master line and top cover insert cut lines. Note position of hand for cutting 45° bevels.

11. Cut along the two covers cut lines just made. The line on the belt side of the bias line should be skived per Fig. 5-7. The other cut may be vertical. Do not cut too deep. If you feel fabric, you have damaged the belt.
12. Cut off the belt at the cutoff line (Fig. 5-5).
13. Remove cover strip. Note the one skived cut and one vertical cut in the cover (Fig. 5-8).

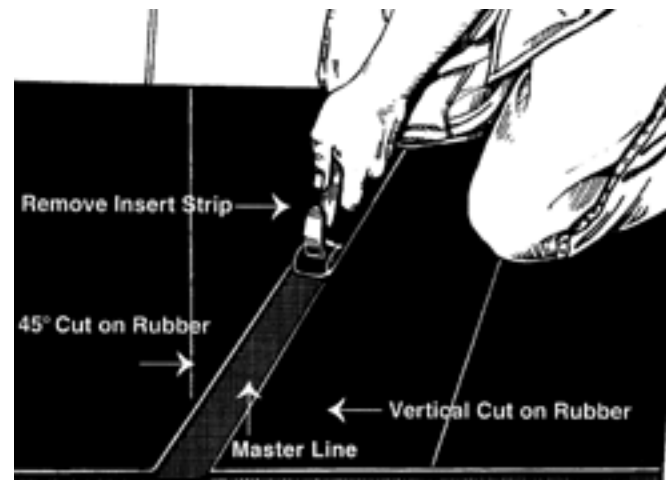

Fig. 5-8: Removing insert strip, note position of master line, and angle cut.

14. From marks made down the edges, redraw the bias line where the cover was removed. Then cut the top ply along this line (Fig 5-9).

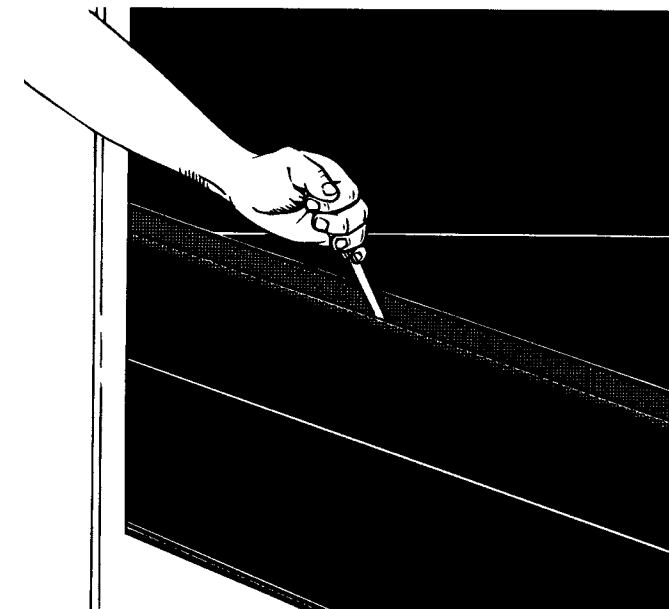

Fig 5-9

15. Prod the top ply loose along the bias line where the cut was just made. Be very careful as you can easily damage the fabric (Fig. 5-10).

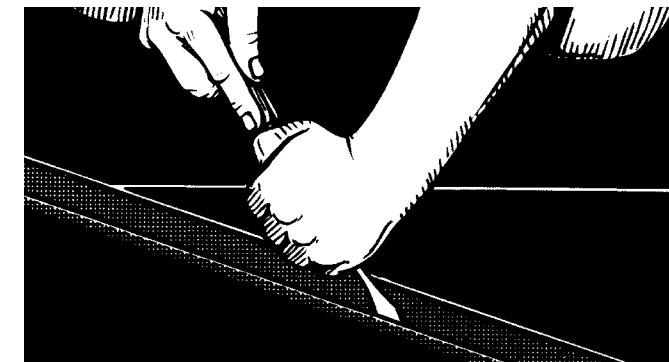

Fig. 5-10

16. Turn the belt end over and mark the cover strip for removal (Fig. 5-11). Cut and remove this cover strip.

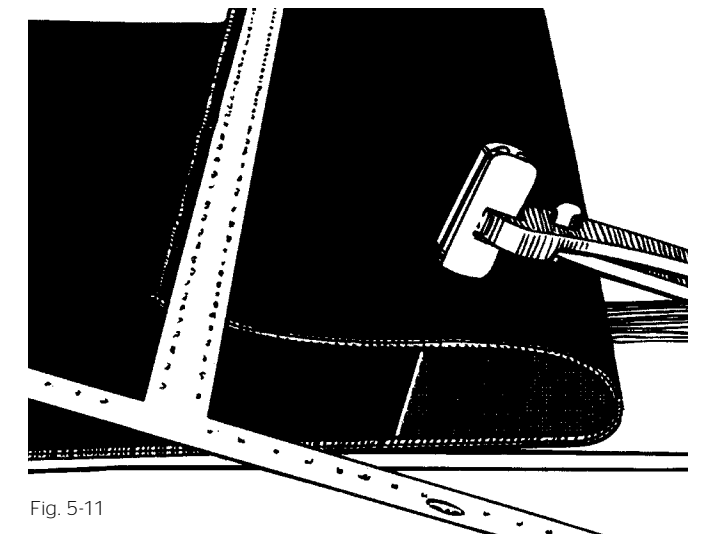

Fig. 5-11

17. Turn the belt end back down and remove the cover and top ply (Fig. 5-12). This is a very difficult pull. If a winch or equivalent is not available, use a come-along and very carefully cut the inside gum with a ply knife.

NOTE: DO NOT NICK THE FABRIC. Damage to the underneath ply will cause premature splice failure.

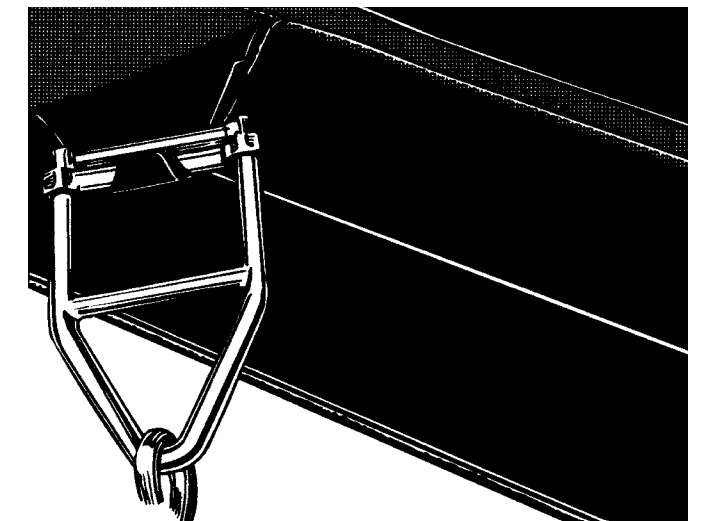

Fig. 5-12

18. The other end of the belt is torn down from the opposite side using the same system. Note the bias length on this end must be measured from the opposite edge that was

20. Refer to Fig. 5-13: Mark a center line on each end of the belt by connecting three center marks, the farthest being a minimum of three times the splice length distance from the master line. Align the belt using the center marks and dry fit the ends to ensure the steps fit together properly. Do not allow any steps to overlap; trim to fit as necessary. After completing adjustments, secure the belt ends in this position. It is common to C-clamp the belt to the work table and nail blocks of wood to the table flush with the belt edges to prevent lateral movement.

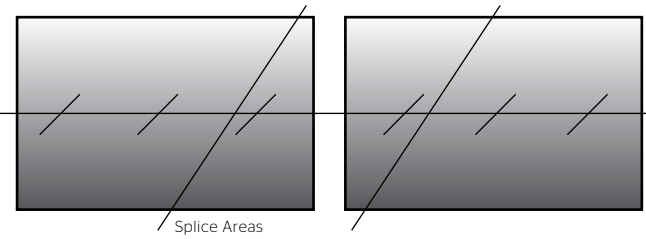

Fig. 5-13

- a. Center-lining the belt ends is necessary to ensure a properly aligned splice.
- b. Place the belt ends on the bottom platens so that the distance between the top of the 45° cover skives equals the splice length.
- c. The center of the splice should be positioned on the center of the bottom platen (both length and width).
- d. The press platens must be a minimum of 6 in. - 8 in. (152mm - 203mm) longer and wider than the completed splice.
- e. On each belt end mark three evenly spaced center locations from the 45° cover skives to the end of the work table.
- f. Extend a string from the marks at the outside ends of each work table, supported by a suitable block to keep the string free from interference by the belt surface.
- g. Use a square to align these end marks to the string.
- h. Check the remaining center marks and adjust the belt as necessary until all marks are aligned.
- i. Verify the splice length distance between the 45° cover skives.
- j. Secure the belt ends in this position. Typically C-clamps are used to secure the belt to the work table.
- k. Nail blocks of wood to the table flush with the belt edges to prevent lateral movement.

21. Using a clean, lint-free cloth, clean all rubber areas

22. Apply one even layer/coat of the specified cement over the entire fabric step area starting at the first ply fabric cut (Fig. 5-14).

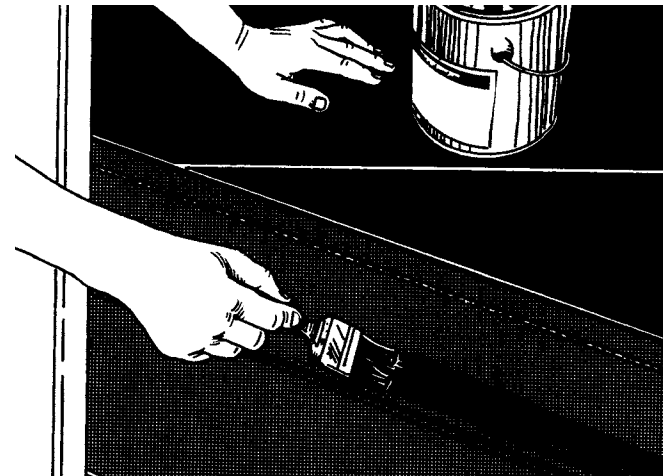

Fig. 5-14

23. After the cement is dried to a tacky feel, using a clean, lint-free cloth and specified solvent, wash/wipe one side of a sheet of the specified inside rubber. Apply the inside rubber to the fabric step area starting at the first ply cut/bias line, proceed to the end of the splice area (Fig. 5-15). Be sure the correct gauge gum and the proper number of layers are used. Roll the rubber thoroughly with a 2 in. (50mm) roller to remove all possible trapped air. The rubber is applied to only one of the stepped ends. Do not remove poly/film from the gum at this time.

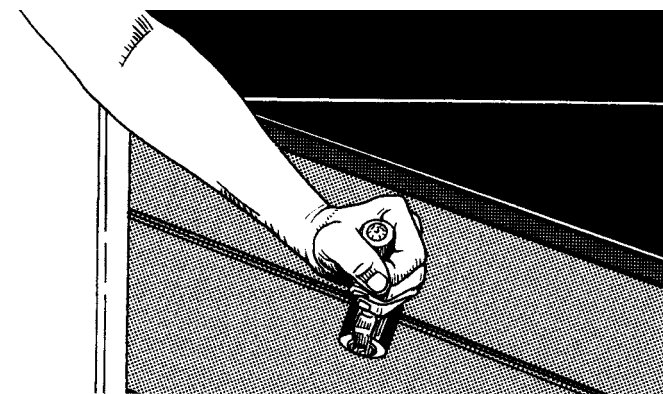

Fig. 5-15

24. On the end which now has the splice gum, mark a ply cut-off line as follows. Measure both edges from the master line. On one edge measure the total step length plus bias length. On the other edge measure only the total step length. Then draw the cutoff line.

26. About 2 in. - 3 in. (50mm-75mm) from the cut just made, make a cut through the film only. Remove the 2 in. - 3 in. (50mm - 75mm) strip of film.
27. Assemble breaker, fill-in gum, and release material on the bottom side using the same system except the bottom gum is to overlap the original cover 1/16 in. to 3/32 in. (1mm to 2mm).
28. With the belt edges properly aligned, carefully lay the ends together making a tight uniform joint at the bottom ply. Make sure fabric is not overlapped (Fig. 5-16).

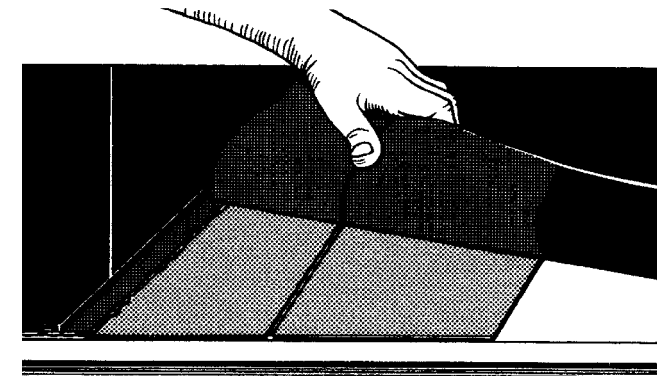

Fig. 5-16

29. Remove the remaining film and lower the remainder of the splice into place. Keep edges aligned.
30. Trim the top ply step/joint - Leave a gap of approximately 1/32 in. to 1/16 in. (1mm to 2mm) wide at the ply seam/joint. All ply seams must have a gap of 1/32 in. to 1/16 in. (1mm to 2mm). Place a noodle or narrow strip of inside rubber over each ply seam gap (Fig. 5-17).

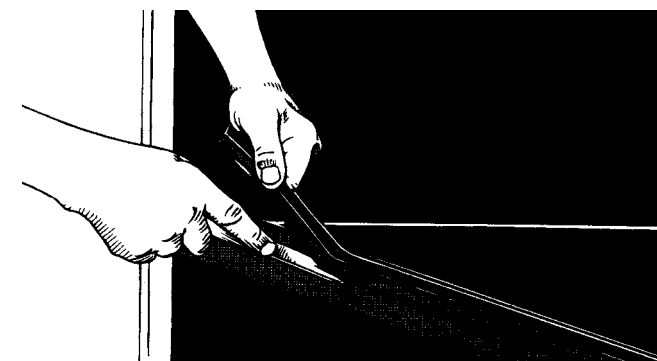

Fig. 5-17

31. Apply an even layer/coat of the specified cement to the fill-in area on the topside. Lay in the breaker - The breaker must be centered over the ply seam and approximately 1/4 in. (6mm) from the bottom of the 45°

33. Use a small straight edge to check for the proper gauge of fill-in gum. The straight edge should make imprints on the gum (Fig. 5-18). Any low spots should be built up.

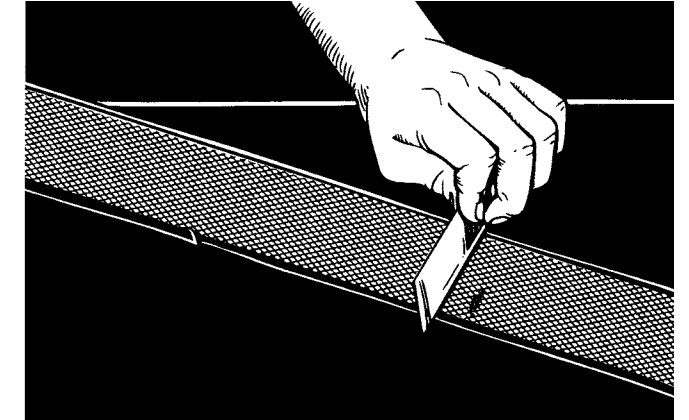

Fig. 5-18

34. Prick the fill-in gum with an awl to release trapped air. Cover with a cemented strip of release material 2 in. (50mm) wider than the gum strip (Fig. 5-19).

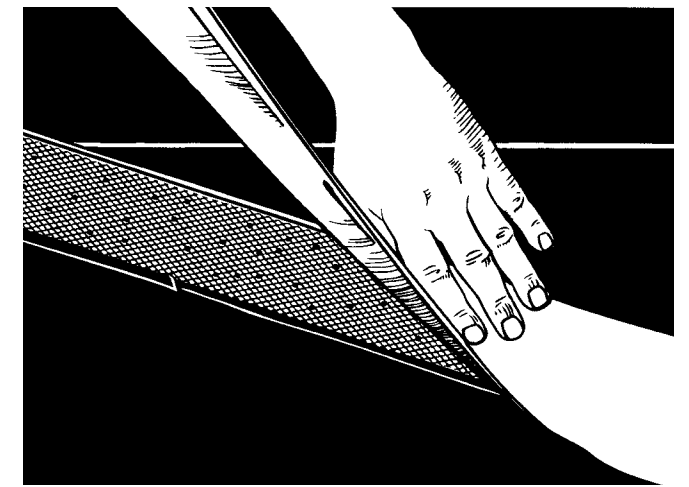

Fig. 5-19

35. To ensure solid edges, guides of the proper gauge must be used. The guides must contact the belt edges for the full length of the splice and extend 6" (150mm) beyond both ends of the press (Fig. 5-20).

NOTE: An exception to the above splice directions sometimes occurs when splicing a new belt into an old one. If the old belt covers are badly worn then both ends of the new section should be stepped from the pulley side. This leaves new unworn top cover on both splices and will provide more uniform vulcanizer pressure. In doing this, one splice will run in reverse to the usual recommendation.

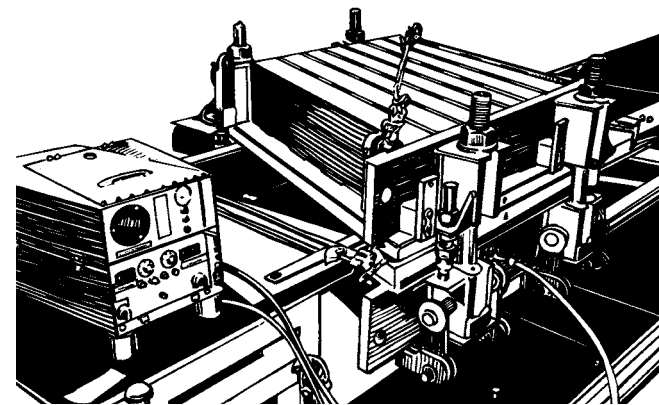

Fig. 5-20

36. After cure, trim the edges of the splice. It is normal for the fabric joints to be spaced 1/4 in. (6mm) or so during cure due to shrinkage.

37. Refer to Section 4 vulcanizing of this manual for vulcanizing instructions.

38. The splice must not be put into service until the splice has cooled at least 130°F (54°C) or to the ambient temperature.

39. Buff inserts and overflows down to original belt gauge to prevent damage from scrapers.

40. Complete all necessary documentation for the splice, splicing procedure, splice materials and splice cure.



Bias Step Finger Splice

1. The Bias Step Finger Splice is made as a Bias Step Splice with finger cut out at the end of each ply.
2. The fingers are necessary to allow better flexibility in the splice as it travels around pulleys while under very high tensions.
3. Currently, only a few Bias Step Finger Splices are specified. The list of Bias Step Finger Splices may include but not be limited to the following:

- ▶ 1350 PIW x 3 ply
- ▶ 1500 PIW x 3 ply
- ▶ 1800 PIW x 4 ply
- ▶ 2000 PIW x 5 Ply
- ▶ 2500 PIW x 6 Ply

NOTE: Each of the following belt types may also be spliced using the Long Life Full Carcass Finger Splice. However, it is not recommended or specified to use the Bias Splice Step Method to splice them. A minimum cover gauge of 3/32" is required for a long life full carcass finger splice (1/8" minimum is preferred).

4. These are general instructions for performing a vulcanized Bias Step Finger Splice only. For further reference for this or any other type of authorized Continental ContiTech splice, contact your local Sales Representative.

NOTE: The references to the TOP and BOTTOM are relative to the belt on the working surface, NOT the actual top and bottom of the belt. I.e. when splicing with the pulley cover UP, the top cover (as referenced here) will be the pulley cover.

5. Refer to the specified splice schematic for detailed splice dimensions before starting the splice.
6. The Bias Step Finger Splices are drawn out in the same manner as straight Bias Step Splice except you will add fingers at the end of each ply.
7. Strip down the belt ends as a Bias Step Splice then cut out the fingers. Refer to Fig. 6-1.
8. The fingers are cut at the end of each ply. Fingers are typically 6 in. (150mm) long x 4 in. (100mm) wide.
9. Check the system for the direction of travel. This will be important during the finger layout. Layout splices so that the pulley cover insert leads the splice into the drive.
10. Align one end on the bottom platen; identify bias to match your machine.

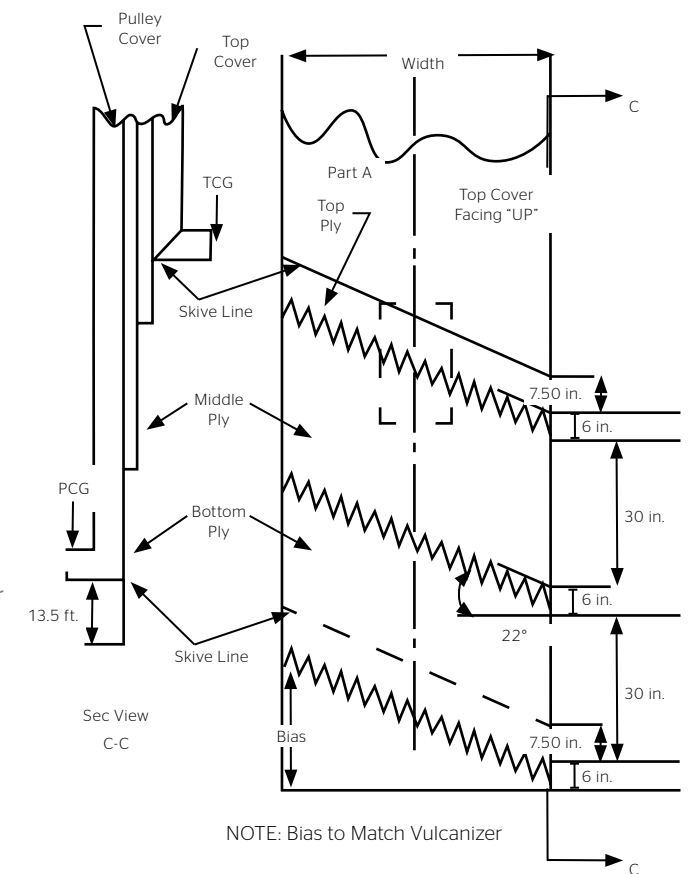
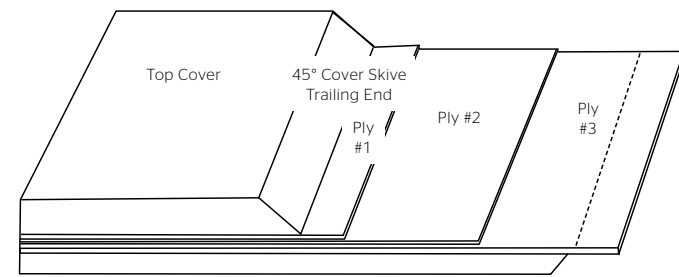

Fig. 6-1



Call Toll Free: 1-866-711-4673
International: +1-727-342-5086





Straight Bias Splice then make fingers at the end of each ply. Fingers added at the end of each step of the Straight Bias Splice to make the Bias Finger Splice.

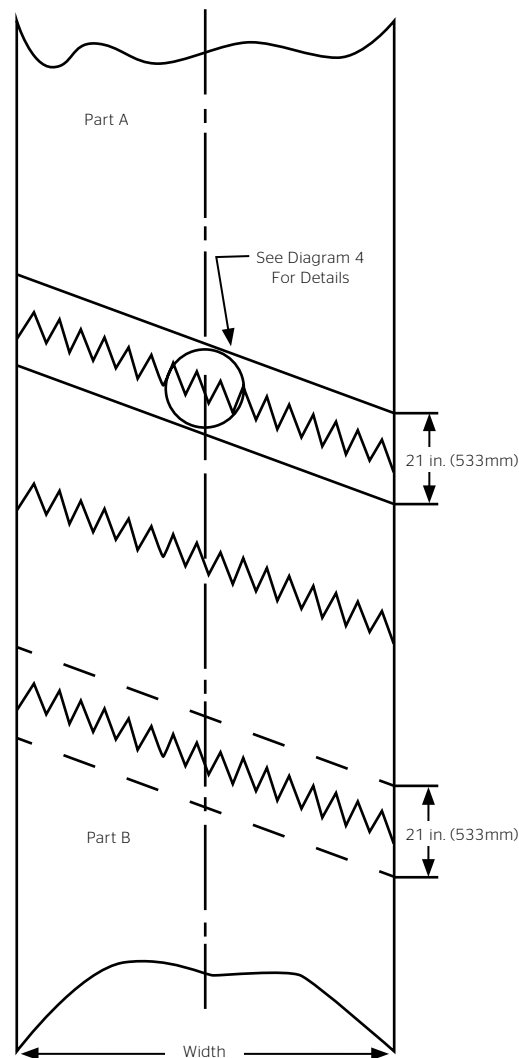

Fig. 6-2

- Fig. 6-2 illustrates the fingers at the end of each step.
- Flip belt and remove rubber from (bottom) insert first.

NOTE: Remove the rubber 1 in. (25mm) below the ply cut (this will be the end of the fingers). Make certain that skive is on a 45° angle. Buff the 45° cover skives with care not to damage the fabric.

- Identify and mark the center line on each belt end. This is a reference point for drawing the fingers and for belt alignment once the fingers are cut (Fig. 6-3).

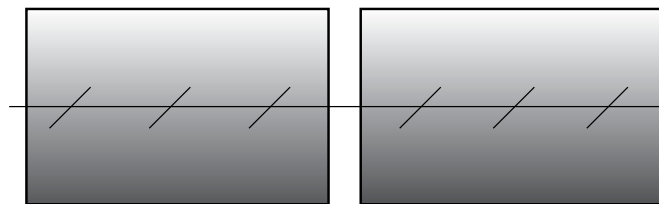

Fig. 6-3

- Remove the top cover rubber from the top fill strip area.
- Using a single ply knife carefully cut the first ply (bias line) (Fig. 6-4).

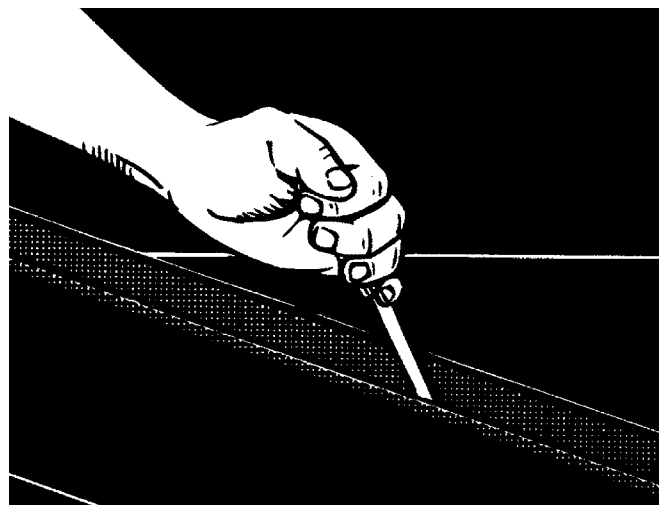

Fig. 6-4

- From the bias line, remove the Top Cover Rubber and first ply full length of the splice.
- Remove the bottom cover insert/fill strip.
- Mark each step length plus finger length on the bare carcass fabric.
- Cut and remove each step length. The 1/4 in. (6.4mm)



Fig. 6-5

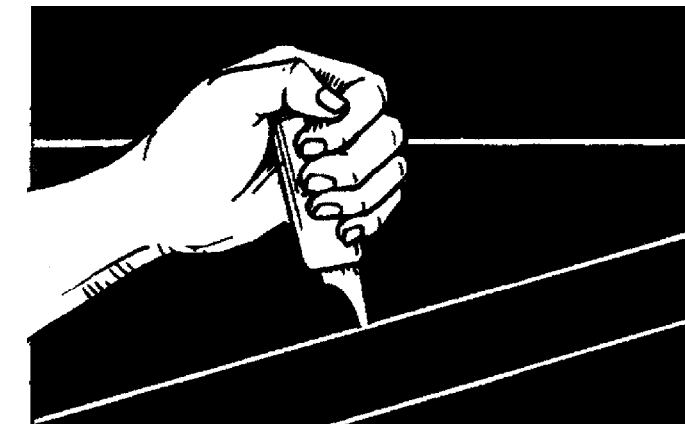

Fig. 6-6

- Prod under the edge of the fingers to be removed from each ply.
- Repeat steps 4-12 for opposite end.
- Care must be taken to assure that "trailing" fingers are opposite of the direction of travel or the outside fingers are pointing opposite the direction of belt travel.
- When both ends are completed, "dry fit" together to assure proper alignment. These ends should be "center-lined" to assure straight. Check to make sure that none of the fingers are touching. Trim all fingers that are touching. There should be 3/16 in. to 1/4 in. (48mm - 64mm) gap between ALL fingers.
- Mark the positions of the cover skives on the release paper covering the bottom platen of the press. This will allow cutting of the fill-in strip for the bottom later.
- Verify the belt end alignment and secure belt ends in place.
- Brush a coat/layer of the specified cement to each belt end. Be sure to cover the inside edges of the fingers with cement.
- Allow the cement to dry until tacky.
- Build the bottom cover insert with the following: bottom

- Lay bottom insert (assembled with breaker and inside gum) on platen. Align with skive marks made earlier on the press surface. Cut skives to match belt, coat with the specified cement and fit one end to the assembly.
- Lay belt end down flat and align fingers. Be sure that fingers are straight.
- Apply inside rubber to the 2nd and 3rd steps only, including fingers, stitch down around fingers, and use razor knife to trim and remove inside gum from area on top of fingers (on top ply).
- Place this inside gum on the top of the fingers on the bottom ply.
- On the end of the belt folded over, apply noodles around edge of fingers (opposite of side that the inside gum was applied to).
- Lay down folded over end, checking alignment of the fingers.
- Build the TOP cover insert with the following: top cover, breaker (inside gum between fingers on breaker), and inside gum, against the carcass.

NOTE: Fingers on the breaker should be at least 1/4 in. (6mm) from the bottom of the cover skives at each belt end.

- Fig. 6-7 shows the breaker with 2 in. fingers

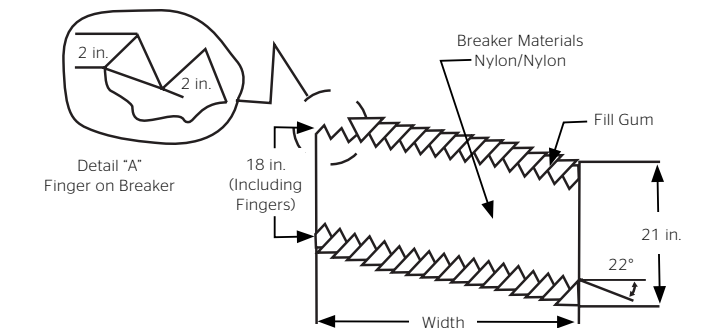

Fig. 6-7: Breaker: detail geometry

- Using a clean, lint-free cloth wipe the 45° cover skives with the specified solvent. Install the top cover insert. The specified cement may be used if additional green tack is needed.
- Properly set up the vulcanizer, cure the splice in accordance with Continental ContiTech Cure Specifications.
- A minimum of one thermocouple per heating element shall be used, with the time, temperature and pressure recorded at determined intervals.

Long Life Full Carcass Finger Splice

NOTE: The following guidelines do not include Lockout/Tag out, positioning belt ends, clamping belt ends or positioning the bottom platen of the vulcanizer. A minimum cover gauge of 3/32" is required for a long life full carcass finger splice (1/8" minimum is preferred)

1. Determine the intended direction of the belt's direction of travel (DOT). The DOT will determine the layout of the splice so the outside fingers point opposite the belt's direction of travel. Refer to Fig. 7-3 below.
2. Center-line both belt ends and secure in place. Center-lining the belt ends is necessary to ensure a properly aligned splice.
 - a. Place the belt ends on the bottom platens so that the distance between the top of the 45° cover skives equals the splice length. The center of the splice should be positioned on the center of the bottom platen (both length and width). The press platens must be a minimum of 4 to 6 inches longer and wider than the completed splice.
 - b. On each belt end, mark four evenly spaced center locations from the 45° cover skives to the end of the work table (in the belt direction).
 - c. Extend a taut string from the mark at the outside ends of each work table, supported by a suitable block to keep the string free from interference by the belt surface.
 - d. Use a square to align these end marks on the belt to the string. Check the remaining center marks and adjust the belt as necessary until all marks are aligned. If necessary, adjust the belt ends to complete alignment. Refer to Fig. 7-1

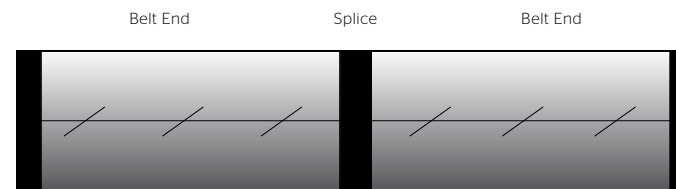

Fig 7-1

3. Outline the splice dimensions on both belt ends.
4. Offset the top and bottom cover skives by approximately 1/2 in. Refer to Fig 7-2. Install the Reverse Cover Skive on the leading end 45° cover skive as shown in Fig. 7-3.

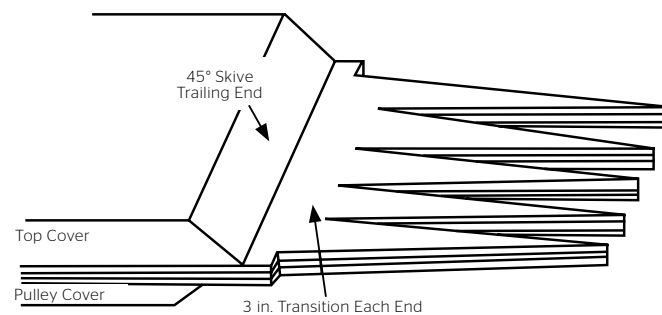
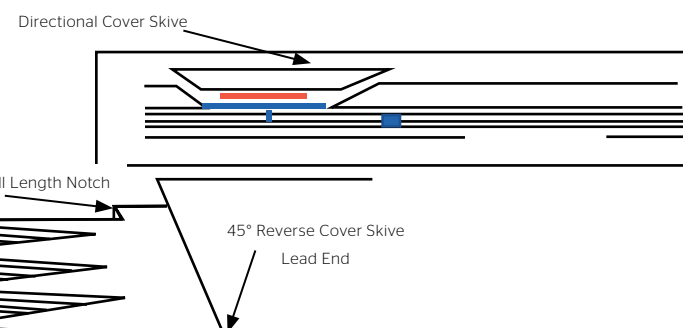

Fig. 7-2

5. Carefully cut the top and bottom 45° cover skives. Do not cut, nick or damage the fabric.
6. Prod and lift the corner of the covers along the 45° cover skive.
7. It is recommended to remove the pulley covers first if it is a much thinner gauge than the top cover. It may be necessary to remove the covers in strips.
8. Remove the top cover. It may be necessary to remove the covers in strips.
9. Carefully buff the cover skives and approximately one inch of the adjoining cover.



10. Use the following instructions if a belt skiver is used: The belt skiver will leave a thin layer of inside rubber on the carcass allowing rubber to rubber bonding.
 - a. Do not remove the covers as explained in line items 6 through 9.
 - b. Draw out the splice and finger dimensions on each belt end.
 - c. Using the skiving tool, mark and remove strips of the top and bottom cover rubber (same width as the blade on the skiving tool) up to the 45° cover skives. Do not damage the adjacent ply.
 - d. Using a belt saw, cut out the carcass fingers.
 - e. Skive the top and bottom rubber from the fingers and transition area. Do not damage the adjacent ply.
 - f. Continue building the splice as detailed in this document.
 - g. Use the specified solvent when laminating all rubber to rubber surfaces. Cement may be used if additional green tack is needed.
11. Beginning approximately 1 1/2 in. (38mm) from the top cover skive, notch the bare fabric and cut-off approximately 1/2 in. to 3/4 in. (12.7mm to 19mm) along each edge of the remaining splice length. Refer to Fig. 7-4.

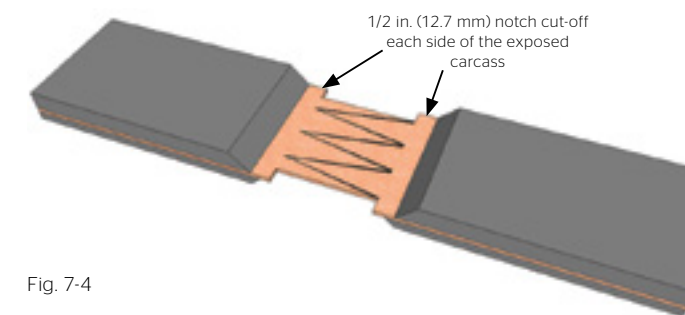

Fig. 7-4

12. Transfer the center line down the center of the bare carcass.
13. At both edges of the carcass, mark the transition distance from the cover skive into the direction of the splice. The transition distance is typically 3 in. or 5 in. (76mm or 127mm) long. Refer to Fig. 7-3.
14. Draw out the fingers on the carcass, starting at the center working towards each edge. Outside fingers must point opposite the belt's direction of travel. Refer to marking and cutting out the Full Carcass Fingers. Refer to Fig. 7-9 at the end of this section.
15. Cut out fingers: Fingers with 2 in. (50mm) base at the belt end of the carcass will be removed. Refer to Fig. 7-9 at the end of this section.

16. Dry fit the belt ends. Proper fit includes a gap approximately 1/8 in. to 1/4 in. (3mm to 6mm) wide between each finger and belt ends are aligned. Refer to Fig. 7-5.

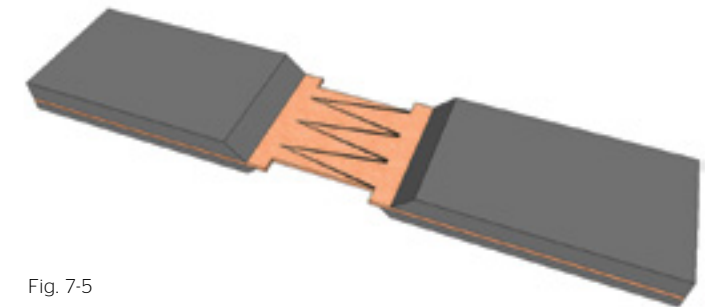

Fig. 7-5

17. Pull back one end of the splice the specified distance to create a slight gap between the fingers.
18. The splice should be centered on the press platen. The bottom platen shall be approximately 8 in. (203mm) longer and 8 in. (203mm) wider than the splice.
19. Secure each belt end in place.
20. Install thermocouple wires on the bottom platen.
21. Cover the bottom platen of the press with release paper
22. Mark out the splice cuts/dimensions on the release paper.
23. Brush an even coat of cement on the top and bottom of the bare fabric and fingers on the trailing end of the splice and the bottom only of the leading end of the splice. Be sure to coat the inside of each finger. Allow the cement to dry until tacky before continuing.
24. Build and position the bottom cover composite: Wipe all cover surfaces with a clean, lint-free cloth and the specified solvent.
 - a. Cut and position the bottom cover rubber to fit based the markings placed on the release paper covering the bottom platen. Be sure the 45° cover skives are cut to match the cover skives at each belt end.
 - b. Position the breaker over the bottom cover rubber. Be sure to have enough of the breaker extending past the edges to overlap the entire splice. Cover the extended breaker so to keep debris and contaminants off.
 - c. Using a porcupine roller, roll the breaker onto the bottom cover rubber so to remove all possible trapped air.
 - d. Using a clean, lint-free cloth, wipe the top side of the installed breaker with the specified solvent. Allow to dry.



Call Toll Free: 1-866-711-4673
International: +1-727-342-5086



27. Carefully dry fit the belt ends to ensure the fingers are still properly fitted and the bottom cover composite is fitted to each end bottom cover skives. The fingers must have a small gap between them. Do not permit the fingers to overlap. Refer to Fig. 7-6.

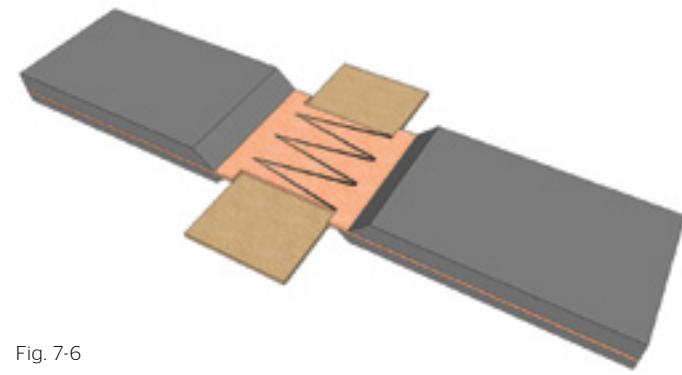

Fig. 7-6

28. Carefully lift the lead belt end. Roll it back out of the way for now.
29. Using a flat roller, roll the fingers of the cemented trailing belt end onto the breaker and bottom cover composite. Using a lint-free cloth wipe the top surface of the trailing end fingers and the exposed bottom cover composite with the specified solvent. Allow the solvent to dry.
30. Coat the fingers and exposed carcass of the lead end with an even layer of the specified cement. Allow the cement to dry until tacky.
31. Install a sheet of the inside rubber over the fitted fingers of the trailing belt end.
32. Using a narrow 1/4 in. (6mm) porcupine roller, roll the sheet of inside rubber onto the top side of the fingers from the trailing belt end. Roll between each finger.
33. Using a larger porcupine roller, roll the inside rubber sheet onto the top side of the fingers. Be sure to roll flat all gaps and voids between the fingers.
34. Position the lead end of the splice and fingers in place. Again be certain the fingers do not overlap.
35. Roll/press the fingers in place.
36. Using a clean, lint-free cloth, wipe the top side of the installed fingers with the specified solvent. Allow to dry.
37. Place a sheet of the specified inside rubber over the fitted fingers and roll in place using the narrow porcupine roller between the fingers and the wide porcupine roller on the top side of the fingers.
38. Install noodles around each finger to fill all voids/low areas in the splice.

40. Tightly wrap the breaker. Working from the outside edges, roll the breaker in place. Refer to Fig. 7-7.

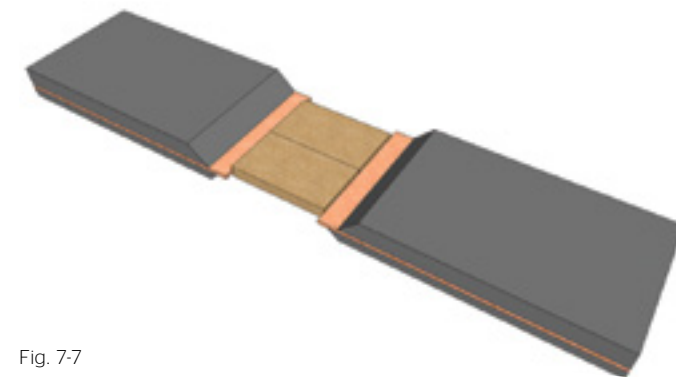

Fig. 7-7

41. Fit the breaker together over one of the center fingers. Do not overlap the breaker. Leave a small gap/seam approximately 1/32 in. (.787mm) wide. Be sure the breaker is tightly wrapped around the edges and fitted/rolled securely in place.
42. Place noodles over each seam of the breaker.
43. Roll with a porcupine roller.
44. Using a clean, lint-free cloth and the specified solvent, wipe the breaker and the bottom surface of the top cover rubber. Allow to dry.
45. Install the top cover rubber and the edge rubber. Be sure to have a tight fit at the 45° cover skives. Refer to Fig 7-8.

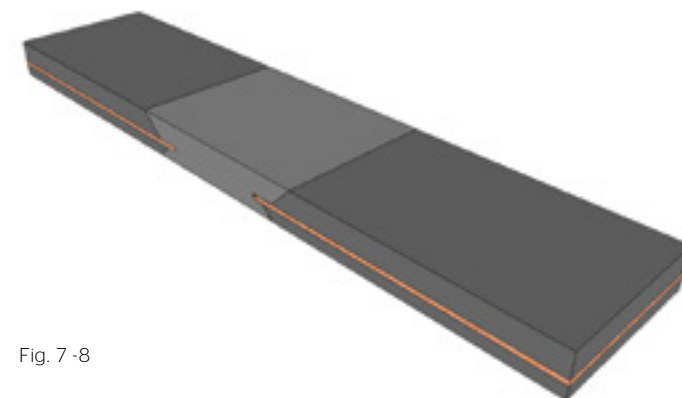

Fig. 7-8

46. Build up the edges of the splice to match the plane/line of the belt's edges.
47. Cover the splice area with release paper.
48. Install required thermocouple wires on the release paper covering the top cover rubber.

49. Install master edge guides and needed fill steel. The master guide and fill steel should be made of aluminum or steel. The master edge guides should be approximately .031 in. to .063 in. (.787mm to 1.6mm) less gauge than the belt (not the splice gauge). The edge guides must be fitted against the belt/splice edges. The master guides and fill steel should extend past the platen ends approximately 6 in. to 12 in. (152mm to 305mm). Balance guides should be used to cover the remaining platen surface.
50. Install the top platen.
51. Secure the master edge guides in place next to the splice/belt's edges with come-a-longs.
52. Follow the required curing specifications for the belt type being spliced.
53. Cure time begins when all thermocouples achieve the specified curing temperature.
54. Monitor and document the cure temperature and pressure in two- or five-minute intervals for the duration of the cure.
55. Cool the press platens to 130°F (54°C) or lower before releasing pressure.
56. Remove top platen, thermocouple wire and release paper.
57. Remove edge guides.
58. Straight edge and trim all overflow from the edges of the cure splice.
59. Buff flow from the cover skive joints. Create a smooth transition from the belt to the splice.

Cure Specifications:

- › Cure temp: 290°F to 5°F (143°C to -15°C).
- › Cure pressure: 100 psi to 130 psi (.69 MPa to .89 MPa)
- › Cure time: Cure time will vary with belt gauge and/or belt type. Refer to Continental ContiTech Splice Manual and/or the specified splice schematic details for accurate cure times and temperatures.
- › Use steel or aluminum edge guides approximately 1/16" (1.6mm) less gauge than the belt

NOTICE: For detailed splice drawing and finger layout refer to Fig. 7-9 on next page.

#1 Draw the splice dimensions on the trailing belt end

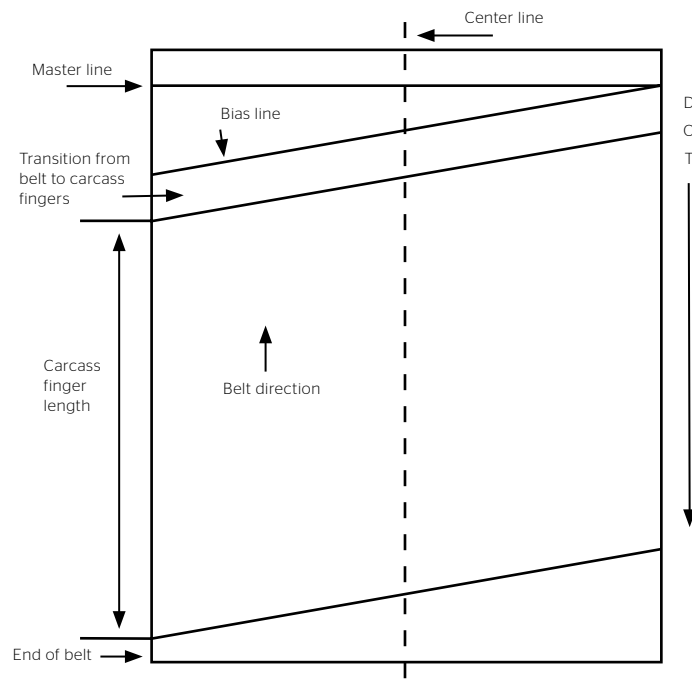

#3 Draw the carcass fingers on the trailing belt end

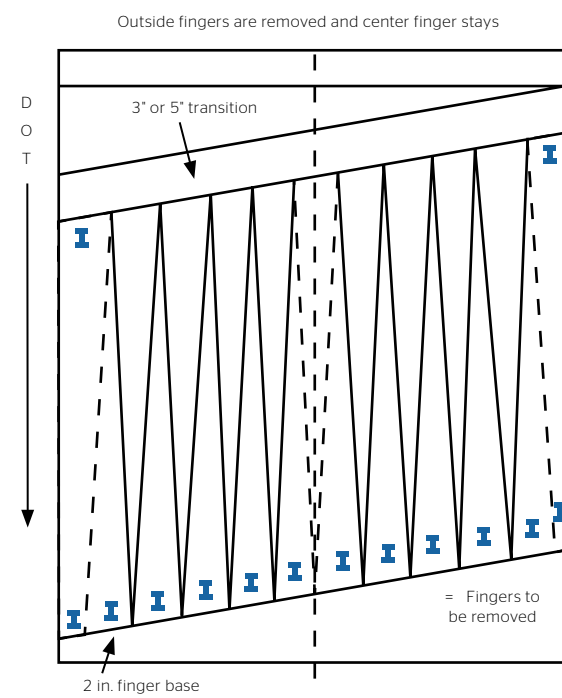

#2 Draw the splice dimensions on the leading belt end

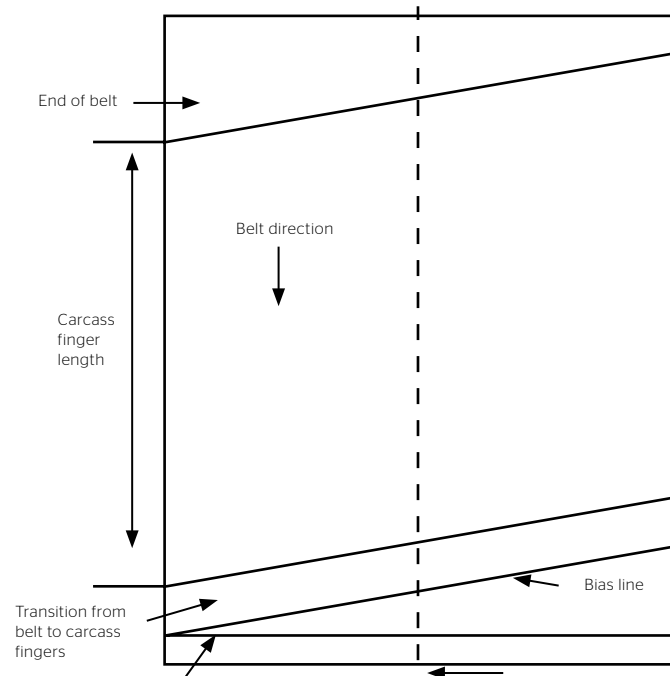

#3 Draw the carcass fingers on the leading belt end

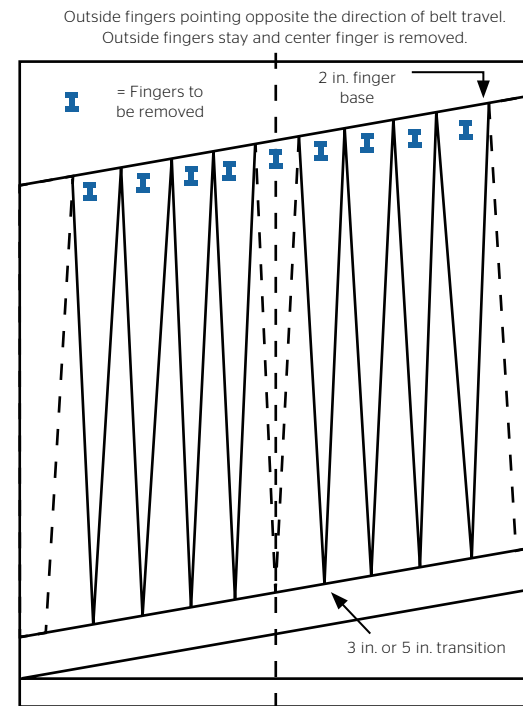

ContiPipe™ Belt Splicing

QUALITY NOTICE: The splicing method to be used will be specified by Continental ContiTech Development: Bias Step Splice or The Long Life Full Carcass Finger Splice. Splice schematics are available for all splices and splicing methods.

1. Pipe Belt Splices may be made using the Bias Step Splice method and/or the Long Life Full Carcass Finger Splice method.
2. The belt manufacturer will recommend the preferred splicing method.
3. The belt's construction may also be a deciding factor as to which splicing method is best.
4. Fig. 8-1 shows the construction of a fabric pipe belt. The areas of most concern are the bend zones at each edge of the belt. Maintaining the bend zones when stripping the belt ends using the Bias Step Splice method may be very difficult.

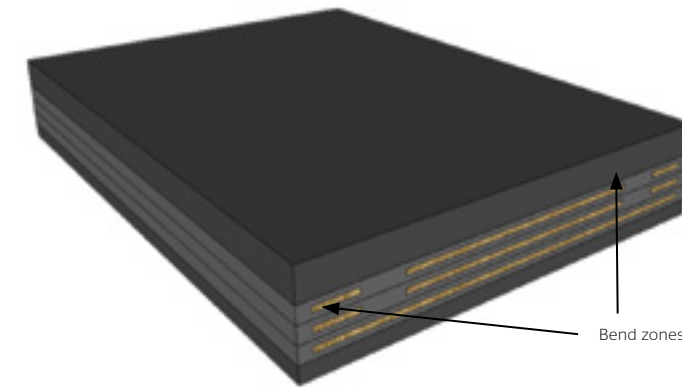

Fig. 8-1

5. In cases where the bend zones cannot be stripped down, the Long Life Full Carcass Finger Splice method will be used.
6. The Bias Step Splice is seen in Fig. 8-2. Notice how the bend zones are even stepped down with the adjacent ply. The bend zones for most Pipe Belts will have a fabric modification. The modification may allow the inside rubber to penetrate through the fabric which will make it impossible to accurately pull/separate the plies.

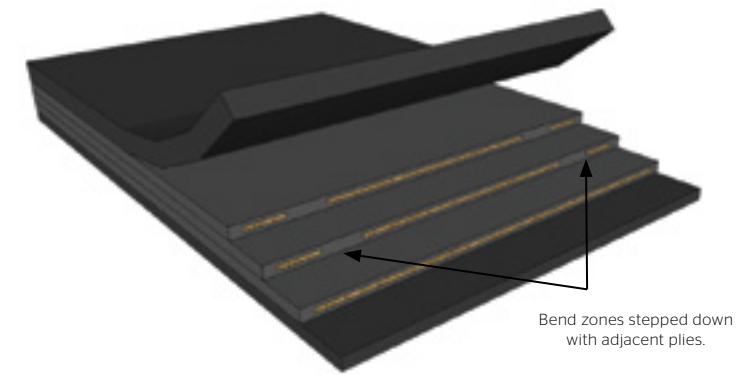

Fig. 8-2

7. Although not necessarily recommended, the bend zones may be removed and replaced with inside rubber and a breaker over top, then cover rubber. Refer to Fig. 8-3.

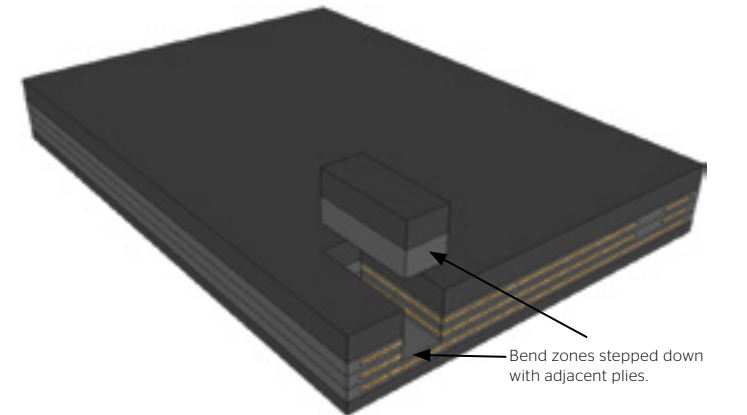

Fig. 8-3

8. When using the Long Life Full Carcass Finger Splice method, the bend zones will become vital parts of the fingers and will remain as built/ designed in the original belt design.
9. As always, the overall gauge and stiffness of the splice are very important. The cumulative overall gauge of the materials required to make the Long Life Full Carcass Finger Splice must be considered/evaluated. Great care must be taken to match overall gauge of the splice with the overall gauge of the belt being spliced as much as possible.

10. The Long Life Full Carcass Finger Splice method requires a minimum cover rubber gauge of 0.094 in. to 0.125 in. (2.4mm to 3.2mm) with the 0.125 in. (3.2mm) preferred.
11. Regardless of which splicing method is used, Continental ContiTech's splicing procedures and specification must be followed.
12. It is strongly recommended to follow the specified splice schematic. Splice schematics detailing both splice methods are available and will point out specific splice details/requirements.
13. The splice schematics include:
 - › Accurate drawing of the splice
 - › Splice dimensions
 - › Bias dimensions
 - › Cure specifications



Mechanical Splice

General

In those cases where belt ends are joined with mechanical fasteners, the first requirement for a good splice is that the belt ends be cut square. Failure to do so will cause some portion of the belt adjacent to the splice to run to one side at all points along the conveyor. New belts can usually be squared with sufficient accuracy by using a carpenter's square and working from the belt edge. Used belts may have an indistinct edge, due to wear, and should be square from a center line established by measuring from the edges at a number of points extending back 15 ft. to 20 ft. (5m to 7m) along the belt. This latter method will provide even greater accuracy on new belts.

Major classes of mechanical fasteners include: 1) Bolted Plate, 2) Hinge Plate, 3) Riveted Plate and 4) Hook Type. Since the optimum performance depends on belt construction, service conditions, pulley diameters and tension, it is recommended that the fastener manufacturer be contacted for proper selection.

You may select the recommended Fastener Plate Type to match the specified belt type from the Heavyweight Conveyor Belt Catalog.

Squaring the Belt End

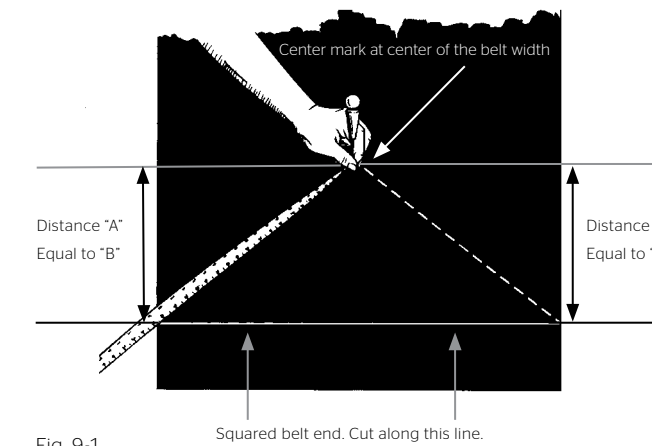

Fig. 9-1

Swinging Arch Method (Fig. 9-1)

- › Carefully mark a point at the center of the belt width. From this center point, measure equal distances along both edges of the belt towards the belt end and mark each edge. These two diagonal measurements must be equal coming from the center of the belt's width.
- › Draw a straight line connecting these two points or use a straight edge and cut the belt end.

Square and Straight Edge Method (Fig. 9-2)

- › Near the end of the belt - Use a square and straight edge to establish a straight line to be used as the square belt end.
- › Check the square line by laying a square along the opposite edge of the belt.

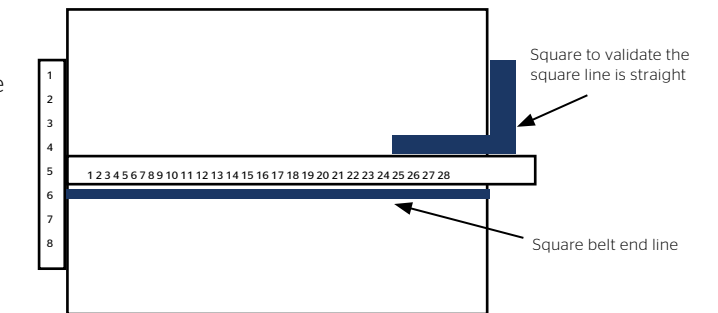

Fig. 9-2

Classes of Mechanical Fasteners

1. Bolted Plates

A commonly used class for heavy belts handling bulk materials is the Bolted Plate type. This fastener uses a series of plates across the belt, on both top and bottom surfaces, spanning the joint and compressed against and into the belt surface by a countersunk bolt in each end of each plate and is illustrated in Fig. 9-3. This class of fastener makes a strong, durable splice with no gap to leak materials. It is not easily taken apart however, due to wear and battering of the bolts in service. Therefore, in some applications requiring frequent opening of the belt splice, it is not very desirable.

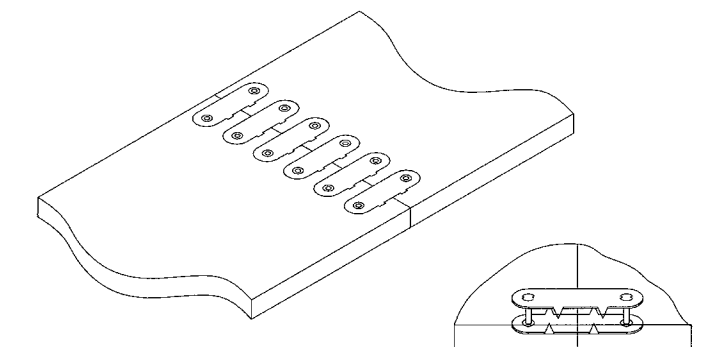

Fig. 9-3

2. Hinged Plate Fasteners

A variation of the plate fastener uses the same bolt and plate attachment to the belt ends but has a hinged connection between the two ends with a removable pin. This permits taking the splice apart more readily, at the expense of some leakage of fine material and slightly less strength. This class of fastener is extensively used underground where conveyors are frequently extended or retracted. Fig. 9-4 illustrates a fastener of this type.

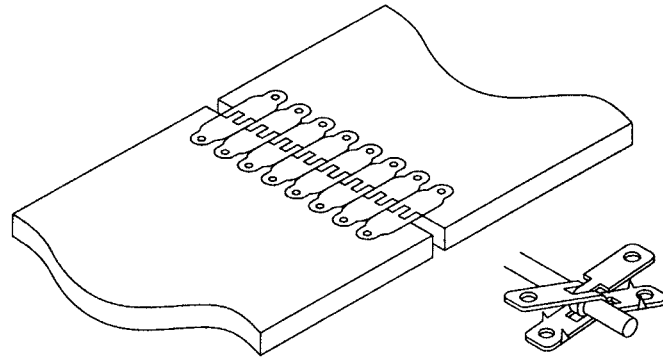

Fig. 9-4

3. Riveted Plate Fasteners

A further variation of the hinged plate-type fastener uses rivets to hold the fastener to the belt ends. Fig. 9-5 and Fig. 9-6 give some examples of these types.

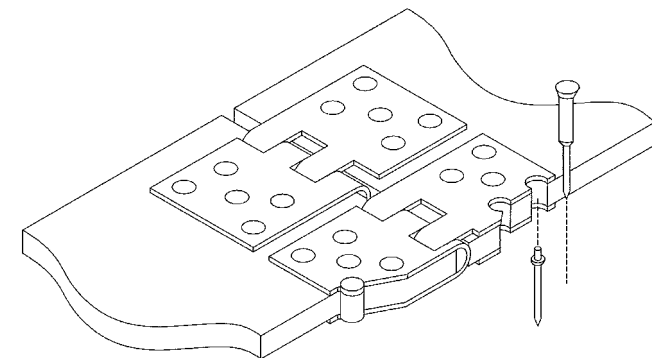
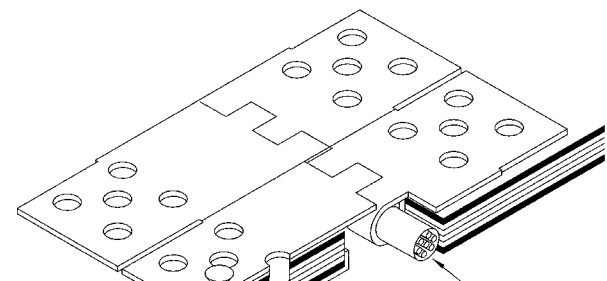

Fig. 9-5



4. Hook Type Fasteners

Hook Type fasteners attach to the belt ends by means of hooks formed from wire or sheet steel. They are applied by forcing the hooks through the belt and clinching on the opposite side. All these types have a hinge pin or rocker pin joint and can be taken apart easily. They permit somewhat more leakage of fine material. The clinching technique of these fasteners has improved in recent years allowing application of this class fastener for higher tension belts. These types are particularly suited for package conveying where their relative smoothness is an advantage as in the case where packages are plowed off the belt. Fig. 9-7 illustrates this type.

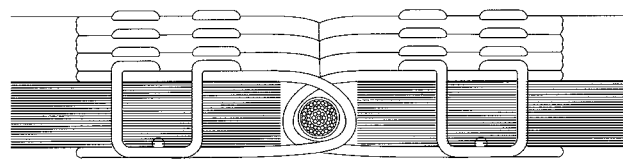

Fig. 9-7

Tightening Fasteners

Extensive testing has proven the necessity for retightening fasteners on a periodic schedule, usually after a few hours of operation, after a few days of operation and then, at intervals of two or three months. This does not preclude, however, retightening at intervals that are more frequent if inspection indicates this to be necessary.

Hazard to the Belt

Failure to inspect fasteners and resulting failures may be a cause of severe belt damage. Particularly, pulling out of fasteners for a portion of the belt width can start longitudinal ripping of the belt. When belt and fasteners have been properly selected, pullout is usually due to insufficiently tight bolts or to worn hooks or plates.

Fasteners for Special Requirements

Many fasteners are available in a variety of different metals designed for special applications. These applications include nonsparking, nonmagnetic, abrasion resistance and chemical resistance. The manufacturer should be contacted for the proper recommendation to be used with any specific application.

Fastener Application Cover Skive Instruction

For heavyweight belting with covers $\geq 1/4$ in. (6mm) top cover and MATO fasteners

1. For MATO fasteners set top cover skive reach back to $1\frac{3}{8}$ in. (35mm). (Fig. 9-8)



Fig. 9-8

2. For MATO fasteners set top cover skive depth to remove $5/32$ in. (4mm) of the top cover. (Fig. 9-9)



Fig. 9-9

3. Please see Table 9-1 for additional pulley cover skive requirements:

Overall Belt Gauge

Fastener Type	0 - 0.550 in. (d.)	0.550 - 0.750 in. (d.)	0.750 - 0.875 in. (d.)	0.875 - 2.000 in. (d.)
U35	No Pulley Cover Skive	Skive Pulley Cover using standard procedures	Skive Pulley Cover using standard procedures	Skive Pulley Cover using standard procedures
U37	No Pulley Cover Skive	No Pulley Cover Skive	Skive Pulley Cover using standard procedures	Skive Pulley Cover using standard procedures
U38	No Pulley Cover Skive	No Pulley Cover Skive	No Pulley Cover Skive	Skive Pulley Cover using standard procedures

Table 9-1

Example:

1000/4 1/4X3/32 U38 - OAG= 0.710 - Does not require pulley cover skive

1000/4 1/4X1/4 U38 - OAG= 0.868 - Must skive pulley cover

4. Verify the skive dimensions below (Fig. 9-10):

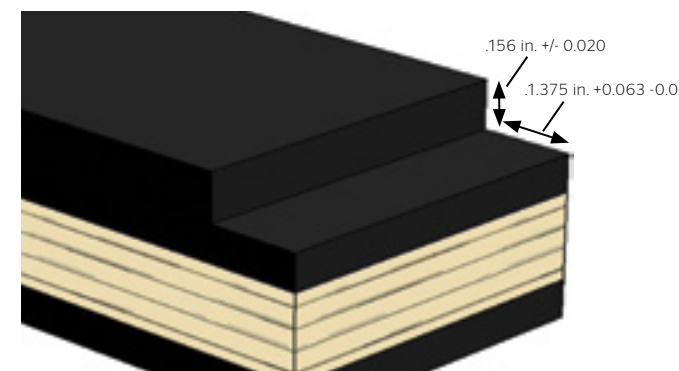

5. Buff top corner of cover skive across the width of the belt "smoothing out" the rectangular point of the skive (Fig. 9-11)

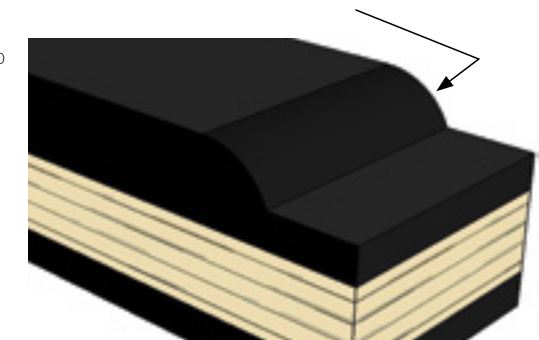

Call Toll Free: 1-866-711-4673
International: +1-727-342-5086



6. Apply MATO fastener to end of the belt per standard specification. Ensure the fastener meets the following:

- › The gap between the end of the fastener and start of the cover skive must be less than 1/16 in. (1.6mm). (Fig. 9-12)

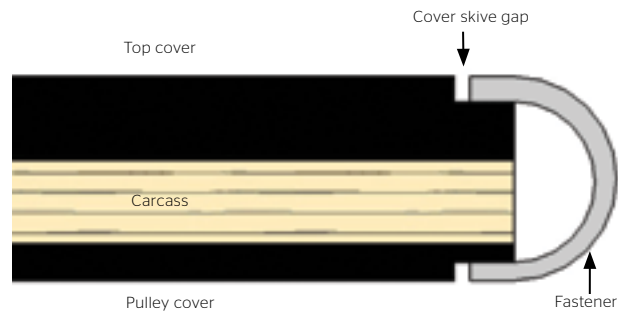

Fig. 9-12

7. The top of the fastener should be flush with the top cover of the belt within 1/32 in. (.8mm). (Fig. 9-13)



Fig. 9-13

8. Ensure cover skive edge is buffed across the width. (Fig. 9-14)



Fig. 9-14



Elevator Belt

General

The type of splice and manner of installation are more critical on elevator belts than for other conveyor belts because of limited take up travel for belt stretch plus the extreme dangers and difficulties generated if a splice separates and the belt falls into the boot.

Installation

Take-up travel on elevator belts is usually limited due to the boot pulley arrangement for material pick-up. The confined space also makes splicing difficult; therefore, it is imperative that the take-up be positioned so that its full outward travel is available when the new belt is first installed. The ideal procedure for installing a new belt is to let the belt, with buckets bolted on, hang over the head pulley for 24 hours. Then pull the belt as tight as possible prior to fastening. This will allow most or all of the inherent stretch in a new belt to hang out. If this procedure is impractical, it is advisable to at least put the belt on as tight as possible to minimize take-up adjustment.

Splicing

There are several customary methods of joining elevator belts. These methods are listed below in order of preference.

Vulcanizing Splice

1. This is the most desirable method and generally least used due to lack of available space for vulcanizing equipment.
2. The belt should be temporarily fastened by another method and run until the initial stretch is eliminated and then vulcanized using normal procedures as outlined in the Continental ContiTech Splice Manual.
3. This run-in period is necessary to eliminate the need for a new splice shortly after installation due to belt stretch.

Butt Strap Splice (Fig. 10-1)

1. A properly designed butt strap splice utilizes the bucket bolts and plate fasteners to join the belt.
2. Prior to installing the butt strap, the belt should be fastened as tight as possible with the correct size plate fastener (following proper installation procedure as previously outlined).
3. The buckets are attached to the butt strap first, using only the bottom row of bucket holes.
4. The butt strap is then attached to the belt using the top row of bucket holes and bolts, which pass through the butt strap and the belt.
5. It is advisable to use the new larger diameter bolt when going through the strap and the belt.

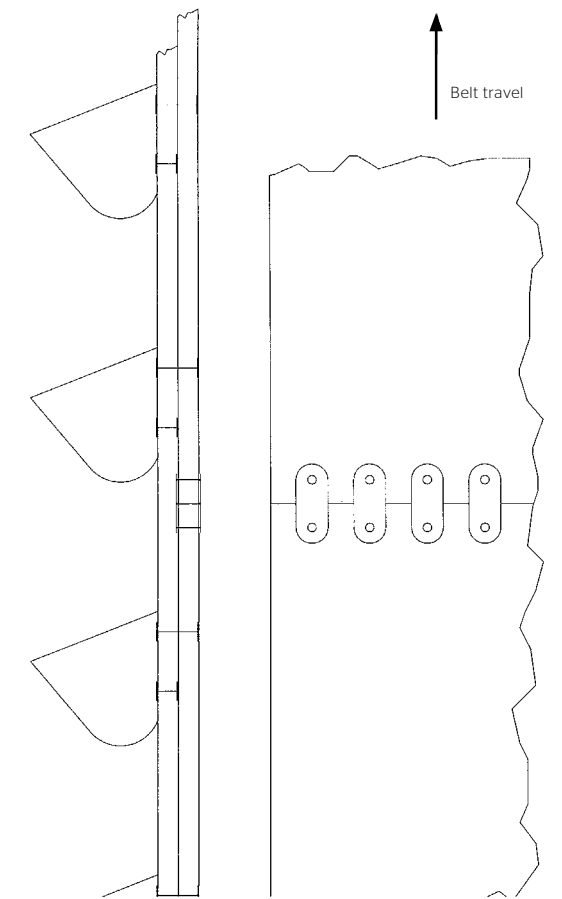

Fig. 10-1

6. The butt strap should be an all-nylon construction equal to elevator rating and compound to the belt itself and should be long enough to overlap 2 to 4 buckets on each side of the belt joint.
7. Continental ContiTech manufactures butt straps from nylon fabric.
8. Prices and delivery are available from your local Sales Representative.
9. The butt strap should be installed with its lightest cover against the belt.
10. Care should be taken to see that the buckets in the strap area do not protrude so far as to hit the elevator structure.

Lap Splice (Fig. 10-2)

1. In this type of splice only the bucket bolts join the belt.
2. The ends of the belt are simply overlapped a minimum of four buckets and fastened with the top row of bucket bolts passing through both pieces of belt.
3. This method should not be used for belts over 5/8 in. (15mm) thick since bumping and excess stress will result when bending over the pulleys.
4. The belt should be fastened so that the pulley side end is always trailing when going over the pulleys.

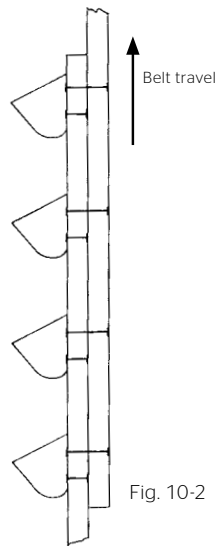

Fig. 10-2

8. Install clamps tightly then retighten at frequent intervals. In this regard, the more the rubber in the belt construction, the greater the possibility of some compression set early in the splice life, which could cause the clamp to loosen. This is the same procedure as is commonly recommended with mechanical conveyor belt fasteners.

Attaching Buckets

1. On thin gauge belts, it is worthwhile to note that the bucket bolt heads properly seat themselves in the pulley cover the belt (Fig. 10-4).
2. The unthreaded bolt neck should not bottom out on the bucket before seating itself properly in the belt. If this happens, the bolts will likely tip and cut their way through. A different style bolt should be utilized in this case.
3. Pylon® Plus elevator belting may be thinner than conventional belting that has been used on a specific installation and, therefore, requires particular consideration of the proper bucket bolts to be used.

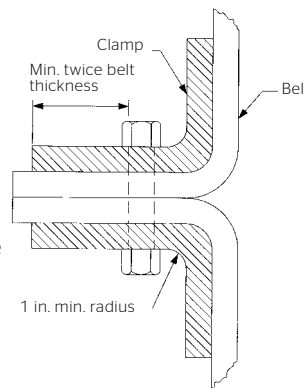
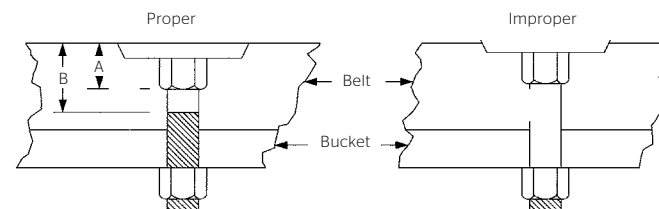

Fig. 10-3 Oil well splice

- Note the drawing of the bolt shown in Figure 10-4.
- In any specific case the bolt used should have an "A" dimension of at least 1/16 in. (1.5mm) shorter than the overall Pylon® Plus belt gauge. In addition, the "B" dimension should be at least 1/16 in. (1.5 mm) less than the overall thickness of belt, bucket wall and any washers used. The nuts should be run down far enough to get good set and compression on the bolt head.
 - In heat applications, an asbestos gasket may be inserted between the bucket and belt contact area, and asbestos washers on the bolt heads to reduce the heat conduction into the belt.
 - All bolts and fasteners should be retightened at least once in 24 hours after start-up to allow for compression set which normally occurs in rubber under pressure.
 - A periodic inspection should then be undertaken and retightening accomplished as necessary.



Mechanical or Plate Fastener Splice

This method is only suitable for lightly tensioned applications. Pylon® Plus belts may be installed with this type of splice at their full elevator tension rating. Ratings of other fabrics require a 50% reduction.

Fasteners should be chosen in accordance with the fastener manufacturer's recommendations.

Oil Well Splice (Fig. 10-3)

1. This type of splice is sometimes used on light duty applications where the belt gauge is thin and the tensions are low. Some users have successfully developed Oil Well splices that are tailored to their equipment and type of belt. For others, the following guidelines should be adhered to:
2. Not to be used on any elevators running at more than 50% of rated belt tension.
3. Clamps should extend to within 1/2 in. (12mm) of belt edges. If they are too much shorter than the belt width, the belt may tend to crease around clamp ends and tear.
4. Plates used to make the clamps should be heavy enough to spread the clamp pressure over as much belt area as possible. Thickness of 1/4 in. (6mm) for light belts and service to 1/2 in. (12mm) for heavy belts and service are generally acceptable.
5. Bend as large a radius as is possible. Radii over 1 in. (25mm) are probably rarely used but even a 1 in. (25mm) radius can induce enormous ply bending stresses in the belt.
6. Form the clamps by bending steel plate rather than rounding one edge of a steel angle bar.
7. Keep bolt holes as far from the ends of the clamps as possible; twice the thickness of the belt with a 1 in. minimum. Less than this is no doubt frequently used.

Solar-Shield® XL 750 Splicing

Splice Dimensions

Currently Solar-Shield® XL 750 belts are being spliced using a Bias Step Splice and are produced with three types of carcass: Polyester, Fiberglass or Nylon.

Please read the following instructions for detailed specifications matching the type of Solar-Shield® XL 750 carcass to be spliced.

1. Cure temperature and pressure remain constant at 325°F/ 136°C and 100 to 130 psi (.689 to .89 MPa) for each carcass type.
2. Step lengths will vary depending on the carcass type.
3. Do not shorten the specified step lengths.
4. Cure the splice to the specified time, temperature and pressure.
5. Follow the established best practices for splicing Continental ContiTech Solar-Shield® belting.
6. Use the Continental ContiTech specified splice materials for Solar-Shield® XL 750 belt splices.

7. Be certain the splice materials have not exceeded the established shelf life.
8. Charts containing the step lengths, carcass type and carcass gauges are available in the Solar-Shield® XL 750 Section of the current "Heavyweight Conveyor Belt Guide" edition and in table A-1 and A-2 of this document.

Splice Bias

The bias lengths should be such that the entire cover insert gum strip can be cured in a single setting of the vulcanizer. The recommended bias lengths are suitable for the most commonly used vulcanizers but they can be adjusted up to 2 in. or 3 in. (50mm - 75mm) if necessary.

NOTE: Bias can be made to match the bias on the vulcanizer. The most common are 20° and 22°. To get the bias for 20° - multiply the width of the belt x 0.36. To find a 22° bias, multiply the width x 0.40. It is recommended that the entire splice be cured in a single cook/vulcanizer setting.

Step Length/Curing Chart

The last step should be increased by a minimum of 1 in. (25mm) or 2 in. (50mm) when laying out a splice to allow for trim.

Table A-1

Vulcanized Rating (PIW)	250	220	375	330	400	500	600	800	1000	1200
Imperial										
Number of plies	2	2	3	3	2	4	3	4	5	6
Fabric Type	P/N	Glass	P/N	Glass	P/P	P/N	P/P	P/P	P/P	P/P
Carcass Gauge (in.)	0.108	0.152	0.182	0.239	0.178	0.253	0.251	0.340	0.429	0.518
Step Length (in.)	12	18	12	18	16	12	16	16	16	16
Metric										
Number of plies	2	2	3	3	2	4	3	4	5	6
Fabric Type	P/N	Glass	P/N	Glass	P/P	P/N	P/P	P/P	P/P	P/P
Carcass Gauge (mm)	2.7	3.8	4.6	5.9	4.5	6.4	6.4	8.6	10.9	13.2
Step Length (mm)	300	460	300	460	410	300	410	410	410	410



Call Toll Free: 1-866-711-4673
International: +1-727-342-5086



Table A-2 Curing Chart

Overall Belt Gauge			Cure Temperature			
in.	mm	Decimal (in.)	Cure Time (mins.)	+/- 5°F	+/- 2.5°C	Cure Pressure
Up to 1/8	Up to 3.1	Up to 0.125	30	325°F / 162°C		100 - 130 PIW
1/8 to 1/4	3.2 to 6.3	0.125 to 0.250	30	325°F / 162°C		100 - 130 PIW
1/4 to 3/8	6.4 to 9.25	0.250 to 0.375	30	325°F / 162°C		100 - 130 PIW
3/8 to 1/2	9.5 to 12.7	0.375 to 0.500	30	325°F / 162°C		100 - 130 PIW
1/2 to 5/8	12.7 to 15.8	0.500 to 0.625	35	325°F / 162°C		100 - 130 PIW
5/8 to 3/4	15.8 to 19.0	0.625 to 0.750	40	325°F / 162°C		100 - 130 PIW
3/4 to 7/8	19.0 to 22.2	0.750 to 0.875	43	325°F / 162°C		100 - 130 PIW
7/8 to 1	22.2 to 25.4	0.875 to 1.000	46	325°F / 162°C		100 - 130 PIW
1 to 1 1/8	25.4 to 28.5	1.000 to 1.125	52	325°F / 162°C		100 - 130 PIW
1 1/8 to 1 1/4	28.5 to 31.7	1.125 to 1.250	56	325°F / 162°C		100 - 130 PIW
1 1/4 to 1 3/8	31.7 to 34.9	1.250 to 1.375	65	325°F / 162°C		100 - 130 PIW
1 3/8 to 1 1/2	34.9 to 38.1	1.375 to 1.500	70	325°F / 162°C		100 - 130 PIW
1 1/2 to 1 5/8	38.1 to 41.2	1.500 to 1.625	78	325°F / 162°C		100 - 130 PIW
1 5/8 to 1 3/4	41.2 to 44.4	1.625 to 1.750	88	325°F / 162°C		100 - 130 PIW

Splicing Material

- Solar-Shield® XL 750 splicing material will not have the usual green tack. It is recommended to make the splice on the bottom plate when possible. Center-line both belt ends and secure in place.
- It is very important to maintain a relatively clean work environment.
- Use a clean, lint-free cloth, and the specified solvent to keep all splicing surfaces and materials clean and free of debris. Do not saturate the carcass when cleaning. Allow the surfaces to dry thoroughly before continuing.
- Specified cement is M-916-C
- Stir the cement thoroughly before using.
- Apply one even coat over the entire carcass.
- Spread an even layer/coat of the mixed cement to the carcass section of the splice. Allow the cement to dry until tacky before continuing (a slight tacky cement feel is recommended).
- Wiping all rubber surfaces with solvent before use may

- Additional green tack may be achieved by brushing an even layer/coat of the mixed cement to the surface of the side of the inside rubber matching to the carcass fabric.
- Using the specified cement between layers of the splicing rubbers may also create better tack. Allow all cemented surfaces to dry until tacky.

Building the Fill Strips

Cover skives are cut at a 45° angle. Use caution when cutting the cover skives to not damage the adjacent fabric ply.

Procedure

- The technique for splicing fabric belts is essentially the same for any number of plies. A 3-ply construction is illustrated in the sketches and instructions that follow.
- Technical notice: For splices where the top cover rubber gauge is 1/8 in. (3.2 mm) and greater use the reverse cover skive on the lead end of the top cover fill strip.
- Measure the splice length; in addition, 1 in. (25mm) trim starting from the end of the belt. Draw the master line. A square and straight edge are generally used to mark

halved and the result will usually give an accurate line. Mark the cutoff line, which is parallel to the bias line (Fig. 11-1).

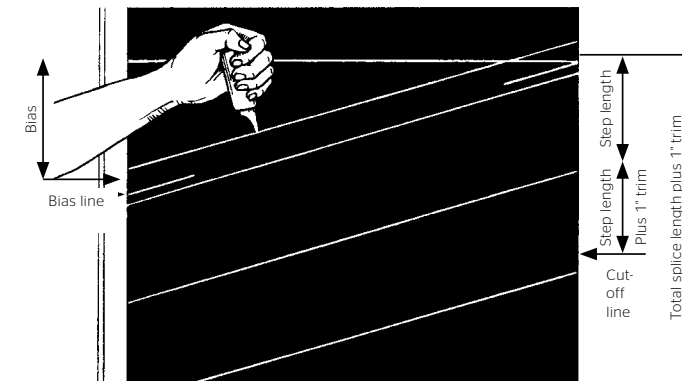

Fig. 11-1

- Measure off the bias length and draw the bias line to the end of the master line on the opposite edge (Fig. 11-2). This line marks the location of the top ply cut after the cover gum is removed.

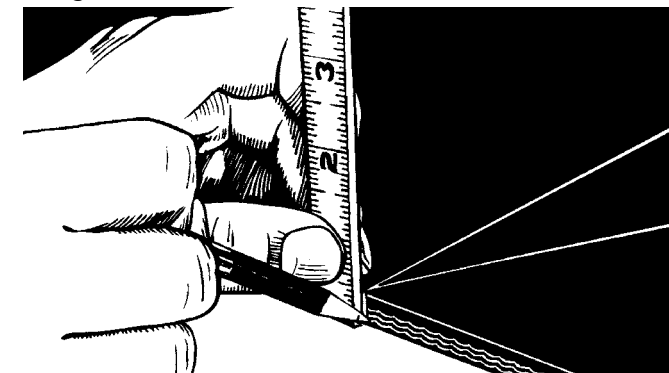

Figure 11-2: Marking the ply cuts down the edge of the belt.

- Extend the end of the bias line down over the belt edge.
- From the bias line measure toward the end of the belt a distance equal to the total number of steps plus 1 in. (25mm) trim.
- Lay out the cover strip for removal. Draw one line parallel to and approximately 1/2 in. (13mm) from the bias line and on the splice side. Draw a second line on the belt side of the bias line but at a distance of 2 in. (50 mm) (Fig 11-3).

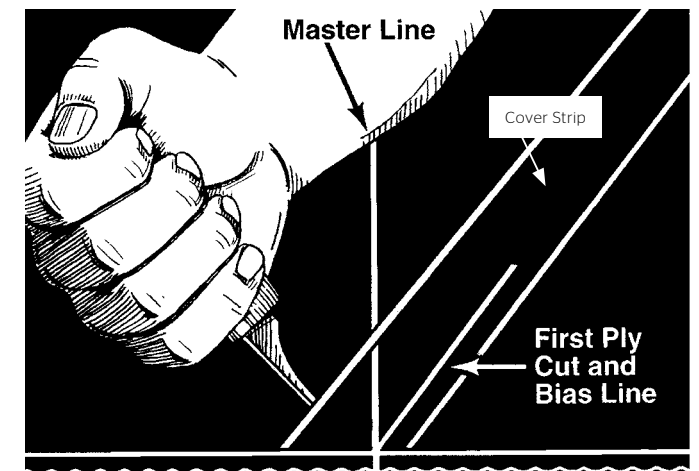

Figure 11-3: Showing master line and top cover insert cut lines.

Note position of the right hand and knife blade angle when cutting 45° bevel.

- Cut along the two covers cut lines just made. The line on the belt side of the bias line should be skived per Fig. 11-3. The other cut may be vertical. Do not cut too deep. If you feel fabric, you have damaged the belt.
- Cut-off the belt at the cut-off line (Fig. 11-1).
- Remove the cover strip. Note one skived cut and one vertical cut in the cover (Fig. 11-4).

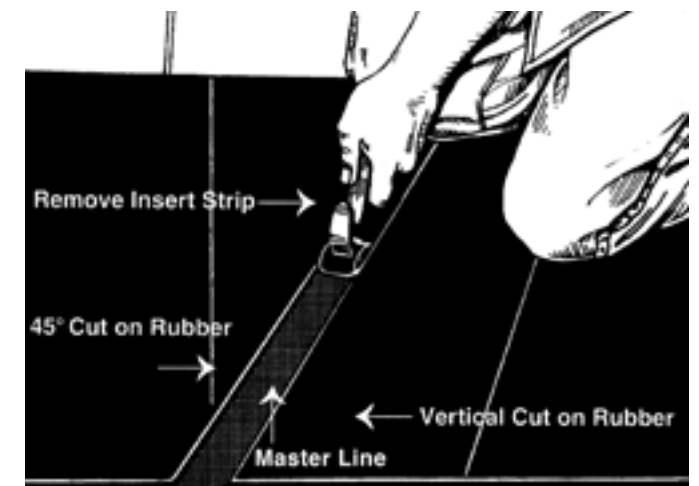

Fig. 11-4: Removing insert strip, note position of bias line, and angle cut.

- Connect the vertical lines marking the bias line. This will now be the first ply cut. Using the correct ply knife, cut the top ply along this line (Fig. 11-5).



Call Toll Free: 1-866-711-4673
International: +1-727-342-5086



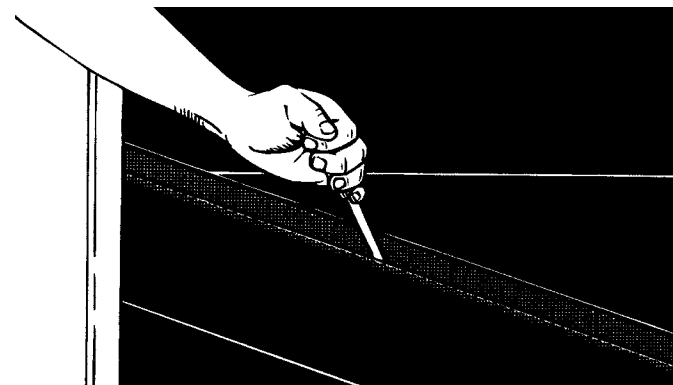

Fig. 11-5

12. Prod the top ply loose along the bias line where the cut was just made. Be very careful as you can easily damage the fabric (Fig. 11-6).

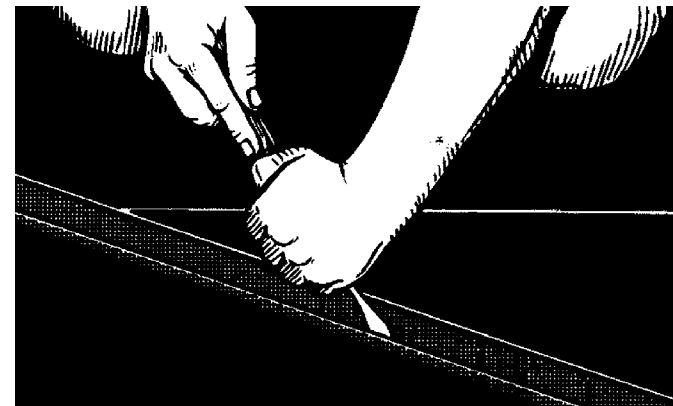
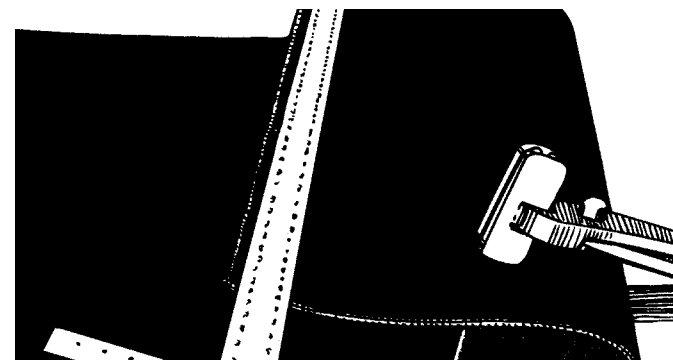

Fig. 11-6: Prodding the first ply up.

NOTE: Take care not to damage the underlying fabric.

13. Turn the belt end over and mark the cover strip for removal (Fig. 11-7). Cut and remove the cover strip.



14. Turn the belt end back down and remove the cover and top ply (Fig. 11-8). This is a very difficult pull. If a winch or equivalent is not available, use a come-along and very carefully cut the inside gum with a ply knife. NOTE: DO NOT NICK THE FABRIC. Damage to the underneath ply will cause premature splice failure.

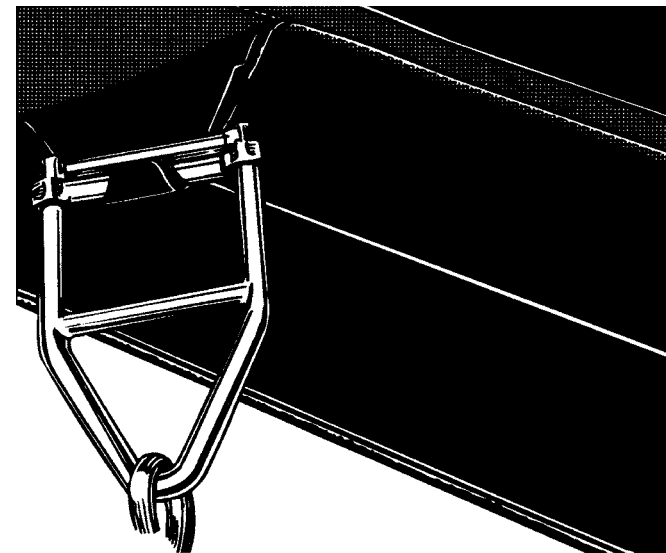

Fig. 11-8

15. The other end of the belt is torn down from the opposite side using the same system. Note the bias length on this end must be measured from the opposite edge that was used on the first end.
16. Use a lightweight, low-speed buffer to buff the 45° cover skives (Fig. 11-9). Do not contact the fabric. Buffing the fabric not only reduces its strength but removes the chemical treatment from the fabric which reduces adhesions.

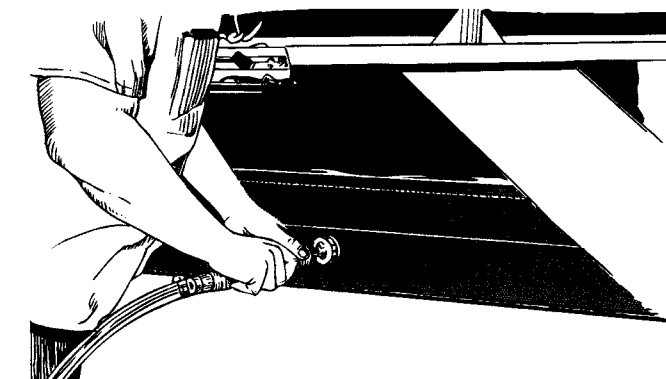

Fig. 11-9

18. Mark a center line on each end of the belt by connecting three center marks, the furthest being a minimum of three times the splice length distance from the master line. Align the belt using the center marks and dry fit the ends to ensure the steps fit together properly. Do not allow any steps to overlap; trim to fit as necessary. After completing adjustments, secure the belt ends in this position. It is common to C-clamp the belt to the work table and nail blocks of wood to the table flush with the belt edges to prevent lateral movement.
19. Clean all rubber areas with the appropriate solvent and allow it to dry thoroughly.
20. Apply an even coat of the proper cement over the entire fabric step area starting at the first ply fabric cut (Fig. 11-10). If two coats of cement are used, allow first coat to dry thoroughly before applying second coat.

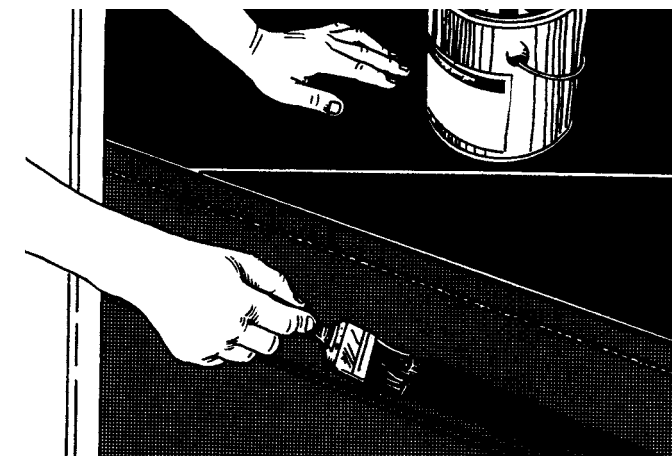

Fig. 11-10

21. Strike/clean the non poly side of the inside gum with the solvent provided in the kit. Allow the solvent to dry thoroughly before continuing.
22. After cement and solvent has dried, apply the inside gum to the fabric step area starting at the first ply cut and proceeding to the end of the splice area (Fig. 11-11). Be sure the correct gauge gum and the proper number of layers are used. Roll gum thoroughly with a 2 in. (50mm) roller. The gum is applied to only one of the stepped ends. Do not remove poly from the gum at this time.



23. On the end which now has the splice gum, mark a ply cut-off line as follows. Measure both edges from the master line. On one edge measure the total step length plus bias length. On the other edge measure only the total step length. Then draw the cutoff line.
24. Cut film, gum and the one ply with a smooth straight cut across the line just marked.
25. About 2 in. - 3 in. (50mm - 75mm) from the cut just made, make a cut through the film only. Remove the 2 in. - 3 in. (50mm - 75mm) strip of film.
26. Assemble the bottom fill-in composite as follows: One layer of inside gum against the carcass. Using the porcupine roller remove all possible trapped air. Tightly fit the cover gum in place over the layer of inside gum. Position the bottom cover rubber to overlap the original cover 1/16 in. to 3/32 in. (1mm to 2mm).
27. With the belt edges properly aligned, carefully lay the ends leaving an approximate 1/16 in. (1.6mm) gap at the joint of the bottom ply. Place a noodle made from the inside gum in the 1/16 in. (1.6mm) gap.
28. Make sure fabric is not overlapped (Fig. 11-12).

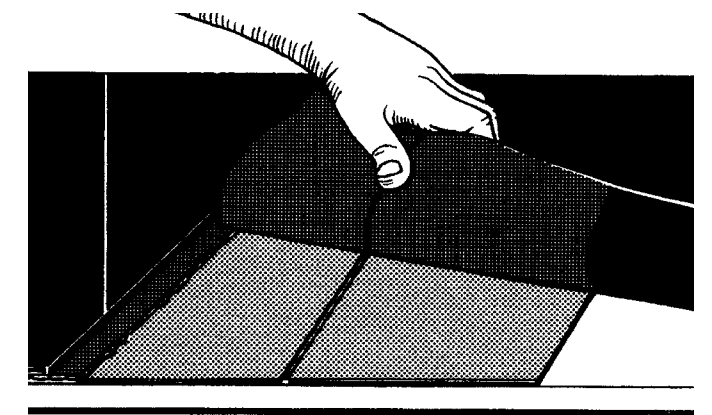

Fig. 11-12

29. Remove the remaining film and lower the remainder of the splice into place. Keep edges aligned.
30. Trim the top ply step making a tight joint with no gap (Fig. 11-13).



31. Apply a second coat of the proper cement after the first coat of cement is dry to the fill-in area on the topside.
32. Place a noodle over the ply seam.
33. Insert inside gum over the exposed carcass in the fill strip. Remove all trapped air.
34. Install the top cover. Roll it into place, and trim.
35. Use a small straight edge to check for the proper gauge of fill-in gum. The straight edge should make imprints on the gum (Fig. 11-14). Any low spots should be built up.

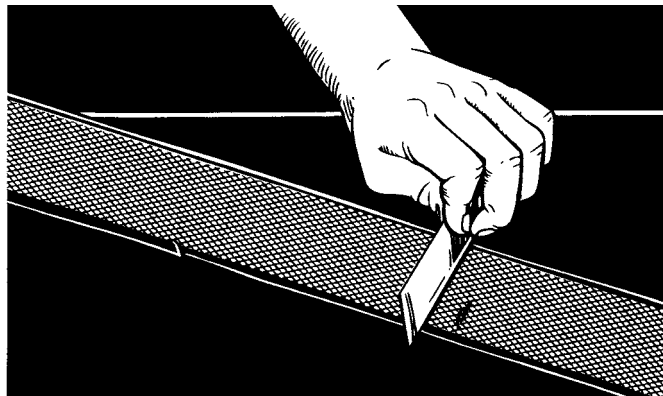

Fig. 11-14

36. Prick the fill-in gum with an awl to release trapped air. Cover with a cemented strip of release material 2 in. (50mm) wider than the gum strip (Fig. 11-15).

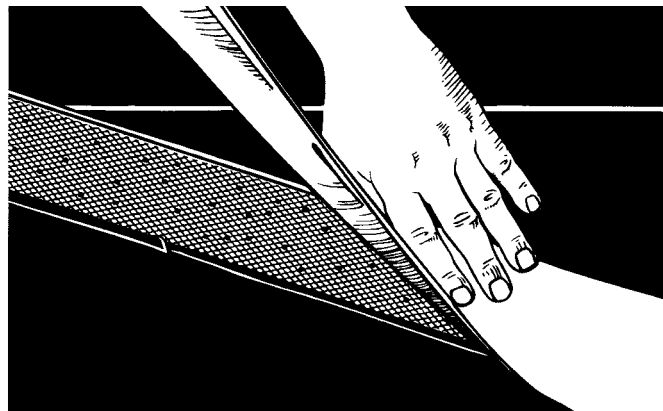

Fig. 11-15

37. To ensure solid edges, guides of the proper gauge must be used. The guides must contact the belt edges for the full length of the splice and extend 6 in. (150 mm) on both ends of the press (Fig. 11-16).

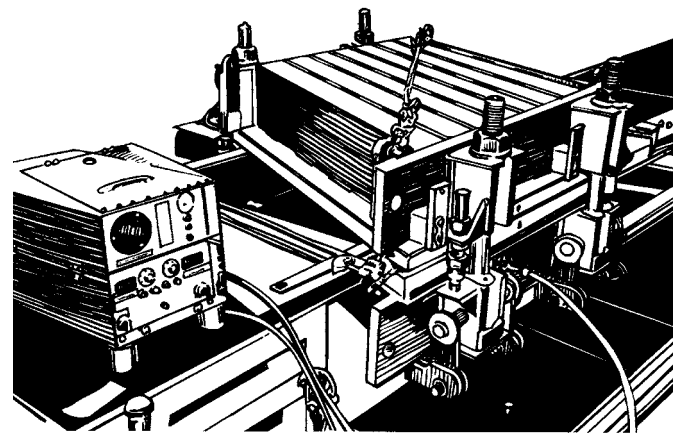

Fig. 11-16

38. After cure, trim the edges of the splice. It is normal for the fabric joints to be spaced 1/4" (6mm) or so during cure due to shrinkage.
39. Refer to Section 4 of this manual for vulcanizing instructions.
40. The splice must not be put into service until the splice has cooled to ambient temperature.
41. Buff inserts and overflows down to original belt gauge to prevent damage from scrapers.

Special Belt Splices

General

These belts listed below are spliced by regular Bias Step Splice or the Long Life Full Carcass Filnger Splicing methods. The Bias Step Splice or the Long Life Full Carcass Finger Splice procedures are described in other sections of this manual with the following exceptions:

Wedge-Grip

1. To locate the bias line on Wedge-Grip belts use the angle along the ribs. Match both belt ends to be spliced at the same time. Cover and top ply are both cut at this line the normal cover insert is not made.
2. The pulley side bias line is located by carefully measuring back from the matching rib.
3. At assembly, the cover ribs butt to form the cover joint. A slight gap is filled with a noodle of inside tie gum. No cover breaker is used.
4. Wedge-Grip splices are cured by filling the design with soapstone and using tight edge irons 1/16 in. (1.6mm) thinner than the belt.

Bareback

1. When removing the ply next to the bare ply, the edges of the bare ply tend to unravel. To prevent this, make one ply cut parallel to the edge, 1/4 in. (6mm) from the edge, in the ply being removed. Then, after removal, the remaining 1/4 in. (6mm) strips can be removed with a sharp flat knife.

2. A small strip of uncured inside gum 1/4" (6mm) wide should be laid across the full width of the belt on the top and bottom ply butts to seal the fabric joints.

Cleated Belt

In order to achieve proper vulcanizer pressure, two procedures have been used:

1. Skive off the ribs in the vulcanizer area.
2. If rib skiving is undesirable then a 1/4 in. (6mm) to 3/8 in. (9mm) layer of uncured gum can be placed over the ribs during cure. In doing this, cure time must be increased to accommodate the added thickness and all four sides of the cure area must be blocked as securely as possible to prevent excessive flow of the added gum which could lead to loss of pressure on the splice during cure.

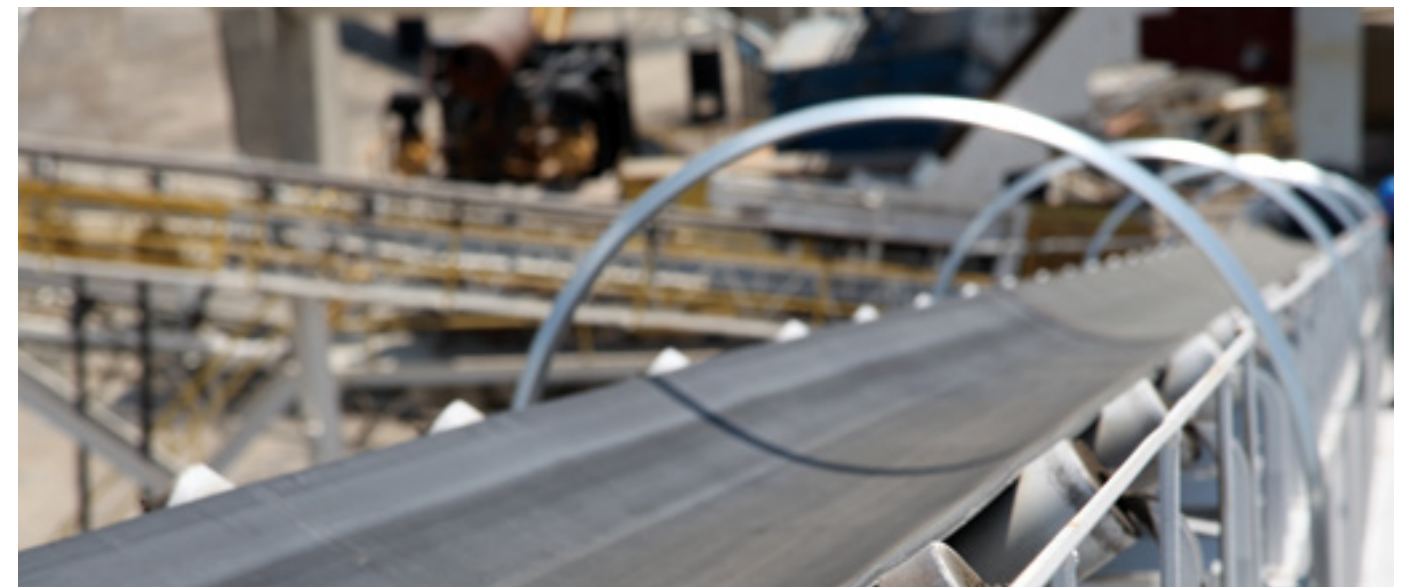

Fold Belt 600 2 Ply

The Fold Belt has longitudinal grooves that must be filled with rubber or talc during vulcanizing to maintain pressure. Failure to do this will result in ply blows along the groove (Fig. 12-1).

NOTE: All other standard construction fold belts follow standard Pylon splicing instructions - located in section IV with the same exception noted above.

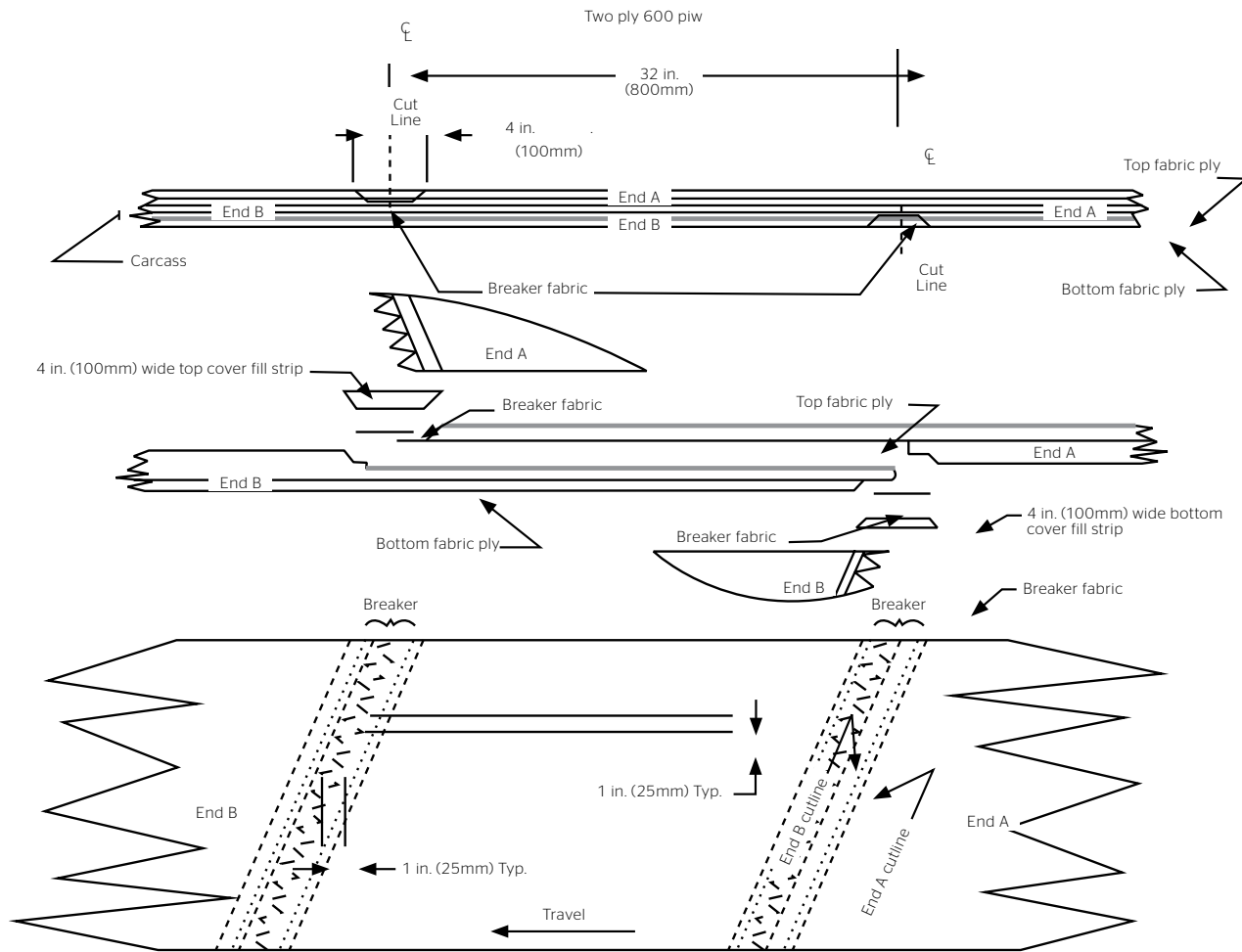

Fig. 12-1: Fold-belt 600 splice

ContiTech



Contact

ContiTech
NAFTA Headquarters
703 S. Cleveland Massillon Road
Fairlawn, OH 44333-3023 U.S.A.
1-800-235-8872

Canada

1-800-263-7788
FAX 1-888-464-4397

Germany

+49 (0)511 938 02
mailservice@contitech.de

www.contitech.us

Continental



ContiTech. Engineering Next Level

As a division of the Continental Group, ContiTech is a recognized innovation and technology leader in natural rubber and plastics. As an industry partner with a firm future ahead of us, we engineer solutions both with and for our customers around the world. Our bespoke solutions are specially tailored to meet the needs of the market. With extensive expertise in materials and processes, we are able to develop cutting-edge technologies while ensuring we make responsible use of resources. We are quick to respond to important technological trends, such as function integration, lightweight engineering and the reduction of complexity, and offer a range of relevant products and services. That way, when you need us, you'll find we're already there.



The content of this publication is not legally binding and is provided as information only. The trademarks displayed in this publication are the property of Continental AG and/or its affiliates.

1727

GOODYEAR
GOODYEARBELTING.COM

Call Toll Free: 1-866-711-4673
International: + 1-727-342-5086

**We Ship
World Wide**