

# BELTING PRODUCTS AND SERVICES CATALOG



INDUSTRIAL

AGGREGATE

SPECIAL SERVICE

AGRICULTURAL

FOOD SERVICE

**APACHE**  
HOSE & BELTING CO., INC.

**GOODYEAR**  
RUBBER PRODUCTS INC.

Call Toll Free: **1-866-711-4673**  
WebSales@GoodyearRubberProducts.com

**We Ship  
World Wide**

## **QUALITY AND DURABILITY**

### **VALUE-ADDED, PRODUCT INSPECTION -VENDOR CERTIFICATION**

Before our fabricated belting products are delivered, they must pass two sets of careful inspections. We first verify the quality of the raw materials before the fabrication process. Then after fabrication is completed, we run tests to ensure the high degree of quality that is built into everything Apache produces. Our state-of-the-art production facility in Cedar Rapids, Iowa is ISO 9001: 2000 Certified.



## **BELTING SERVICES**

### **INSTALLATION AND SPLICING SERVICES**

Apache belt technicians are factory trained to install, splice, vulcanize and train conveyor and elevator belts in the field.

Additional services include:

- Computerized design assistance for belt applications
- Conveyor system surveys
- Custom belt fabrication
- Professionally applied belt lacing and endless splices
- Hole and bucket punching
- Die rule & waterjet cut parts



## **INVENTORY**

### **TOP QUALITY PRODUCTS**

Apache maintains a large inventory of top quality products supplied by a vast network of manufacturers from throughout the world. These supplier relationships and global sourcing initiatives allow us to quickly provide our partners premium quality products at very competitive prices.

## INDEX

### INDUSTRIAL BELT

SPEC #	PART #		PAGE#
#1	20027202	2 Ply 150 1/32 x BB GR2	8
#2	20027301	2 Ply 150 1/32 x 1/32 GR2	8
#2A	20026910	2 Ply 150 1/16 x BB GR2	8
#3	20000010	2 Ply 150 1/8 x 1/32 GR2	8
#4	20003990	2 Ply 150 1/8 x 1/16 GR2	8
#6A	20029525	2 Ply 220 1/8 x BB GR2	8
#26C	20029690	2 Ply 220 1/8 x BB MOR	9
#8	20013600	2 Ply 220 1/8 x 1/16 GR2	9
#9	20017500	2 Ply 220 3/16 x 1/16 GR2	9
#10A	20029655	3 Ply 225 1/16 x BB GR2	9

### HEAVY DUTY INDUSTRIAL BELT

#11	20023005	3 Ply 330 3/16 x 1/16 GR2	9
#12	20026039	3 Ply 330 1/4 x 1/16 GR2	9
#243	20027007	4 Ply 440 1/4 x BB GR2	10
#13	20026815	4 Ply 440 1/4 x 1/16 GR2	10
#246	20029852	1 Ply 440 1/4 x 1/8 GR2	10
#14A	20027210	3 Ply 600 3/8 x 3/32 GR2	10

### GRAIN BELT

#21	20027200	2 Ply 150 1/32 x BB MOR	10
#23A	20021628	2 Ply 220 1/16 x 1/16 SCORFR Grain	10
#25A	20021630	3 Ply 330 1/16 x 1/16 SCORFR Grain	11
#27A	20021635	3 Ply 600 1/16 x 1/16 SCORFR Grain	11
#27B	20021640	4 Ply 440 1/16 x 1/16 SCORFR Grain	11

### BALER BELT

#36	20021510	2 Ply 220 1/32 x 1/32 Baler Belt	11
#36A	20021515	2 Ply 220 Tex x Tex Baler Belt	11
#36B	20029150	3 Ply 225 Diamond Top x MSK Baler Belt	11
#36D	20029170	3 Ply 330 Chevron Top x MSK Baler Belt	12
#37A	20021605	3 Ply 330 Tex x Tex Baler Belt	12

### SPECIAL SERVICE BELT

#24B	20017332	2 Ply 220 3/16 x 1/16 MOR	12
#26A	20021820	3 Ply 330 3/16 x 1/16 MOR	12
#26B	20029734	3 Ply 330 3/16 x BB MOR	12
#30A	20021598	2 Ply 220 3/16 x 1/16 SCORFR MSHA	12
#41	20021199	2 Ply 220 3/16 x 1/16 400° MAXI-Heat	13
#41A	20021237	2 Ply 220 3/16 x 1/16 700° SUPER-Heat	13
#42	20021030	2 Ply 220 3/16 x 1/16 350° ORS-HMB	13
#42A	20021093	3 Ply 330 3/16 x 1/16 350° ORS-HMB	13
#177	20026766	3 Ply 330 1/4 x 1/16 400° MAXI-Heat	13
#43A	20026790	3 Ply 330 1/4 x 1/16 700° SUPER-Heat	13

**IMPRESSION TOP BELT**

<b>SPEC #</b>	<b>PART #</b>		<b>PAGE#</b>
#103B	20029575	2 Ply 220 Chevron Top x BB	14
#46	20030200	3 Ply 105 Black RT x FS	14
#47	20029005	2 Ply 150 Black RT x BB	14
#47A	20029000	2 Ply 150 Tan RT x BB	14
#48	20030220	3 Ply 135 Pure Gum RT x BB	14
#48A	20030205	3 Ply Poly 150 Brown Nitrile RT x BB	14
#51A	20030230	3 Ply 135 Blue Carboxylated Nitrile RT x BB	15
#219	20034520	PVC 120 Green RT x FS	15
#53	20029009	2 Ply 150 Black Wedgegrip x BB	15
#53B	20029200	2 Ply 150 Tan Wedgegrip x BB	15
#54	20029505	3 Ply 105 Black Ridge Top x FS	15
#55A	20034603	PVC 120 Black CTII OR x FS	15
#56	20049012	2 Ply 160 Black Steep-Lok x BB	16
#61A	20035506	PVC 120 Black RT x FS	16
#62A	20033600	PVC 100 Black Bucket Top OR x FS	16
#62B	20035525	PVC 120 Black Crescent Top x FS	16
#185	20035530	PVC 200 Black Crescent Top x FS	16
#63B	20034800	PVC 120 Black Z Top OR x FS	16
#242	20034605	PVC 150 Black Chevron Top II x Brush	17
#204	20035527	PVC 150 Black Crescent Top x Brush	17
#99	20028700	3 Ply Poly 105 White Tyler Wire x FS	17
#102	20028506	3 Ply Poly 135 White Nitrile Meat Cleat x FS	17
#233	24005980	2 Ply Poly Inverted Pyramid PVC Top Cover x BB	17

**SLITTABLE CHEVRON BELT**

#57A	20029603	2 Ply 220 1/8 x 1/16 Durocleat GR2	17
#58	20029601	2 Ply 220 1/8 x 1/16 Durocleat MOR	18
#178	20029605	3 Ply 330 1/8 x 1/16 Durocleat GR2	18
#59B	20029615	3 Ply 330 1/8 x 1/16 Durocleat MOR	18
#56B	20029602	2 Ply 220 1/8 x BB Durocleat MOR	18
#247	20029607	3 Ply 330 5/32 x BB Durocleat MOR	18

**DESCRIPTION ABBREVIATION KEY**

BB = Bare Back	FS = Friction Surface	MSK = Mini Skim Coat	RMV = Rubber Modified Vinyl
Brush = Brushed Bottom	GR2 = Grade 2 (SBR)	OR = Oil Resistant	RT = Roughtop
CBS = Cover Both Sides	IMPG = Impregnated	ORS-HMB = Oil Resistant Hot Asphalt	SC = Static Conductive
CR = Cross Rigid	MOR = Moderate Oil Resistance	PVC = Poly Vinyl Chloride	Tex = Texture
CTII = Chevron Top II	MRT = Mini Roughtop	PU = Polyurethane	
FR = Fire Retardant	MSHA = Mine Safety Health Act	POLY = Polyester	



## INDEX

### PVC - RMV BELT

SPEC #	PART #		PAGE#
#60	20032710	2 Ply 60 Matte PVC Checkout Counter x BB	18
#60A	20032940	2 Ply 100 Black RMV x FS	19
#60B	20032945	3 Ply 150 Black RMV x FS	19
#61A	20035506	PVC 120 Black RT x FS	19
#62A	20033600	PVC 100 Black Bucket Top OR x FS	19
#62B	20035525	PVC 120 Black Crescent Top x FS	19
#55A	20034603	PVC 120 Black CTII OR x FS	19
#63B	20034800	PVC 120 Black Z Top OR x FS	20
#242	20034605	PVC 150 Black Chevron Top II x Brush	20
#204	20035527	PVC 150 Black Crescent Top x Brush	20
#219	20034520	PVC 120 Green RT x FS	20
#64A	20035498	PVC 100 Black Cover x FS	20
#64B	20035508	PVC 120 Black FS x Brush	20
#65	20035501	PVC 120 Black Cover x FS	21
#65A	20035502	PVC 120 Black OR Cover x FS	21
#65B	20035499	PVC 100 Black OR Cover x FS	21
#66	20035500	PVC 120 Black CBS	21
#66A	20038199	PVC 150 Black OR CBS	21
#67	20038200	PVC 150 Black Cover x FS	21
#67A	20038207	PVC 200 Black Cover x FS	22
#69A	20038206	PVC 200 Black ORSC CBS	22
#69B	20038500	PVC 250 Black ORSC CBS	22

### PVC ELEVATOR BELT

#66A	20038199	PVC 150 Black OR CBS	22
#70A	20038208	PVC 200 White OR CBS	22
#69A	20038206	PVC 200 Black ORSC CBS	22
#69B	20038500	PVC 250 Black ORSC CBS	23
#72	20039000	PVC 350 Black ORSC CBS	23
#73	20040009	PVC 450 Black ORSC CBS	23
#259	20040015	PVC 600 Black ORSC CBS	23

### WHITE FOOD BELT

#91	20028503	2 Ply Poly 70 White Nitrile 3/64 x FS	23
#91B	20032950	2 Ply 100 White RMV x FS	23
#91C	20032951	3 Ply 150 White RMV x FS	24
#221	20028507	Polymate 135 White RMP COS	24
#92	20028505	3 Ply Poly 105 White Nitrile 3/64 x FS	24
#92A	20028504	3 Ply PNT 150 White Nitrile 3/64 x FS	24
#94A	20035400	PVC 100 White Cover x MSK	24
#239	20035535	PVC 120 White Crescent Top x FS	24
#95	20035496	PVC 120 White Cover x MSK	25
#95B	20033550	PVC 120 White CTII OR x MSK	25
#70A	20038208	PVC 200 White OR CBS	25
#98	20028650	3 Ply Poly 105 White Butyl 1/32 x FS	25
#99	20028700	3 Ply Poly 105 White Tyler Wire x FS	25
#102	20028506	3 Ply Poly 135 White Nitrile Meat Cleat x FS	25
#104	20028625	3 Ply Poly 105 White Teflon x FS	26
#223	24041040	2 Ply White Urethane x IMPG Bottom SC	26

**WHITE FOOD BELT *continued***

<b>SPEC #</b>	<b>PART #</b>		<b>PAGE#</b>
#224	24041010	2 Ply White PVC x IMPG Bottom SC	26
#252	20032953	3 Ply 150 White RMV CRSC x BB	26
#230	20038225	4 Ply 200 White RMV CRSC x BB	26
#67B	20038509	2 Ply PVG 220 White 1/16 x 1/16 SC	26
#222	24041030	1 Ply White Urethane x IMPG Bottom SC	27

**PACKAGE HANDLING / LIGHT DUTY BELT**

#106	20030518	3 Ply 105 Black FS x FS	27
#107	20031018	3 Ply 105 Tan FS x FS	27
#109	20031506	4 Ply 140 Tan FS x FS	27
#110	20032700	3 Ply Brown Nitrile FS x FS	27
#111	20032650	5 Ply Brown Nitrile FS x FS	27
#203	20032690	7 Ply Brown Nitrile FS x FS	28
#195	20032499	3 Ply PNT 150 Tan Nitrile Slip Top x FS	28
#113	20032500	4 Ply Tan Slip Top x FS	28
#114	20032550	3 Ply Hot Stock and Water	28
#118A	20031515	4 Ply 200 Black Nitrile FS x FS	28
#118B	20030515	2 Ply 220 Tan BB x BB w/Black Skim	28

**THERMOPLASTIC BELT**

#244	20040550	ATI 150 Black Urethane x FS	29
#249	24041050	2 Ply Green Urethane x IMPG SC	29
#250	24041070	2 Ply Green PVC Roughtop x BB	29
#251	24041090	2 Ply Black PVC x BB SC	29
#229	24009752	2 Ply Green PVC SC x BB	29
#223	24041040	2 Ply White Urethane x IMPG Bottom SC	29
#224	24041010	2 Ply White PVC x IMPG Bottom SC	30
#252	20032953	3 Ply 150 White RMV CRSC x BB	30
#230	20038225	4 Ply 200 White RMV CRSC x BB	30
#253	20032955	3 Ply 150 Black RMV CRSC x BB	30
#231	20032957	4 Ply 200 Black RMV CRSC x BB	30
#222	24041030	1 Ply White Urethane x IMPG Bottom SC	30
#60	20032710	2 Ply 60 Matte PVC Checkout Counter x BB	31

**TRANSMISSION BELT**

#240	24041195	HAM-5P	31
#241	24041193	F-1	31
#236	24005513	XH500-4	31
#237	24005512	XH500-5	31
#238	24005514	XH500-6	31

**DESCRIPTION ABBREVIATION KEY**

BB = Bare Back	FS = Friction Surface	MSK = Mini Skim Coat	RMV = Rubber Modified Vinyl
Brush = Brushed Bottom	GR2 = Grade 2 (SBR)	OR = Oil Resistant	RT = Roughtop
CBS = Cover Both Sides	IMPG = Impregnated	ORS-HMB = Oil Resistant Hot Asphalt	SC = Static Conductive
CR = Cross Rigid	MOR = Moderate Oil Resistance	PVC = Poly Vinyl Chloride	Tex = Texture
CTII = Chevron Top II	MRT = Mini Roughtop	PU = Polyurethane	
FR = Fire Retardant	MSHA = Mine Safety Health Act	POLY = Polyester	

## INDUSTRIAL BELT

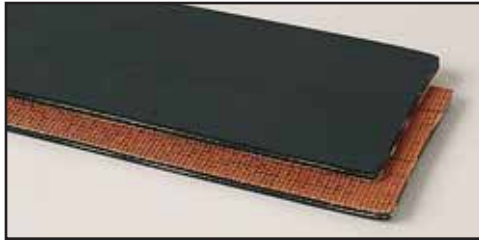

### #1 2 Ply 150 1/32 x Bare Back Grade 2

This belt specification fits light duty applications such as package handling, sorting lines, and applications requiring minimum tensions with no need to resist heavy impact. Standard grade rubber covers resist abrasion and weathering in non oily applications. Used as an economical general purpose belt and popular in many agricultural applications, including potato sorting and transport on slider beds.

**Temperature range:** -25° F to 225° F. **Thickness:** 5/32". **Weight:** .075 piw.  
**Minimum pulley diameter:** 4". **Recommended fasteners:** #2 Hook, #125 Staple, #15 Alligator.  
**Part Number: 20027202**



### #2 2 Ply 150 1/32 x 1/32 Grade 2

This belt specification fits light duty applications such as package handling, sorting lines, and applications requiring minimum tensions with no need to resist heavy impact. Standard grade rubber covers resist abrasion and weathering in non oily applications, including potato sorting and transport in troughing conveyors.

**Temperature range:** -25° F to 225° F. **Thickness:** 13/64". **Weight:** .085 piw.  
**Minimum pulley diameter:** 6". **Recommended fasteners:** #3 Hook, #187 Staple, #25 Alligator.  
**Part Number: 20027301**



### #2A 2 Ply 150 1/16 x Bare Back Grade 2

Excellent light duty conveyor belt with a medium thick abrasion resistant cover. Often used in agricultural applications and in bunk feeders where the belt slides on flat pan surfaces. Good selection for package handling applications where smooth surfaces are permissible. SBR cover provides excellent flex life and resistance to abrasion, making it a good buy for most conveyor applications.

**Temperature range:** -25° F to 225° F. **Thickness:** 3/16". **Weight:** .105 piw.  
**Minimum pulley diameter:** 6". **Recommended fasteners:** #2 Hook, #125 Staple, #20 Alligator.  
**Part Number: 20026910**



### #3 2 Ply 150 1/8 x 1/32 Grade 2

Excellent light duty conveyor belt with medium thick abrasion resistant covers. Often used in agricultural applications and for sand conveying in the sand and gravel industry. Good selection for other light duty applications on troughing conveyors. SBR covers provide excellent flex life and resistance to abrasion, making it a good buy for most conveyor applications.

**Temperature range:** -25° F to 225° F. **Thickness:** 1/4". **Weight:** .138 piw.  
**Minimum pulley diameter:** 8". **Recommended fasteners:** #140 Solid Plate, #187 Staple, #375 Bolt On, #R2 Rivet.

**Part Number: 20000010**



### #4 2 Ply 150 1/8 x 1/16 Grade 2

Excellent light duty conveyor belt with medium thick abrasion resistant cover. Often used in agricultural applications and for conveying pea gravel in the sand and gravel industry. Good selection for other light duty applications on trough conveyors. SBR covers provide excellent flex life and resistance to abrasion, making it a good buy for most conveyor applications.

**Temperature range:** -25° F to 225° F. **Thickness:** 9/32". **Weight:** .154 piw.  
**Minimum pulley diameter:** 10". **Recommended fasteners:** #140 Solid Plate, #375 Bolt On, #R2 Rivet.

**Part Number: 20003990**



### #6A 2 Ply 220 1/8 x Bare Back Grade 2

Excellent medium duty conveyor belt with moderately thick abrasion resistant top cover. Often used in bunk feeders, where smooth surfaces are permissible, wood product, and agricultural applications. SBR cover provides excellent flex life and resistance to abrasion, making it a good buy for most conveyor applications.

**Temperature range:** -25° F to 225° F. **Thickness:** 1/4". **Weight:** .145 piw.  
**Minimum pulley diameter:** 10". **Recommended fasteners:** #140 Solid Plate, #187 Staple, #375 Bolt On, #R2 Rivet.

**Part Number: 20029525**

8 BELT SAMPLES ARE AVAILABLE •

## INDUSTRIAL / HEAVY DUTY INDUSTRIAL BELT

### #26C 2 Ply 220 1/8 x Bare Back Moderate Oil Resistance

Excellent light to medium duty conveyor belt has moderately thick cover with moderate oil resistance to wood chips and many non-petroleum oils. Often used in handling wood products and recycling, where materials contain food oils and greasy waste materials.

**Temperature range:** 0° F to 250° F. **Thickness:** 1/4". **Weight:** .150 piw.

**Minimum pulley diameter:** 10". **Recommended fasteners:** #140 Solid Plate, #187 Staple, #375 Bolt On, #R2 Rivet.

**Part Number: 20029690**



### #8 2 Ply 220 1/8 x 1/16 Grade 2

Excellent medium duty conveyor belt with medium thick abrasion resistant covers. Good selection for sand and gravel portable screening applications on trough conveyors. SBR covers provide excellent flex life and resistance to abrasion, making it a good buy for most conveyor applications.

**Temperature range:** -25° F to 225° F. **Thickness:** 5/16". **Weight:** .167 piw.

**Minimum pulley diameter:** 10". **Recommended fasteners:** #140 Solid Plate, #550 Bolt On, #R5 Rivet.

**Part Number: 20013600**



### #9 2 Ply 220 3/16 x 1/16 Grade 2

Excellent heavy duty conveyor belt with thicker abrasion resistant covers. Excellent general purpose sand and gravel belt. Often used in scrap metal plants and foundries where high impact is not a problem, also used in the wood products industry. Excellent base belt for road machinery. SBR cover provides excellent flex life and resistance to abrasion, making it a good buy for heavy duty conveyor applications.

**Temperature range:** -25° F to 225° F. **Thickness:** 11/32". **Weight:** .195 piw.

**Minimum pulley diameter:** 12". **Recommended fasteners:** #190 Solid Plate, #550 Bolt On, #R5 Rivet.

**Part Number: 20017500**



### #10A 3 Ply 225 1/16 x Bare Back Grade 2

Versatile medium duty belt for handling lumber, pea gravel, and other bulk materials. Flexible belt able to negotiate small pulleys.

**Temperature range:** -25° F to 225° F. **Thickness:** 7/32". **Weight:** .122 piw.

**Minimum pulley diameter:** 8". **Recommended fasteners:** #2 Hook, #187 Staple, #25 Alligator, #R2 Rivet.

**Part Number: 20029655**



## HEAVY DUTY INDUSTRIAL BELT

### #11 3 Ply 330 3/16 x 1/16 Grade 2

Excellent heavy duty conveyor belt with moderately thick abrasion resistant covers. Often used in the aggregate industry for rock conveying and heavy loads. Good selection for other heavier duty applications on troughing conveyors, such as for scrap metal, foundries, and high tensions. SBR covers provide excellent flex life and resistance to abrasion, making it a good buy for most conveyors.

**Temperature range:** -25° F to 225° F. **Thickness:** 13/32". **Weight:** .205 piw.

**Minimum pulley diameter:** 16". **Recommended fasteners:** #190 Solid Plate, #550 Bolt On, #R5 1/2 Rivet.

**Part Number: 20023005**



### #12 3 Ply 330 1/4 x 1/16 Grade 2

Excellent heavy duty conveyor belt with extra thick abrasion resistant covers. Often used in aggregate applications where severe cover wear is normally experienced. Good selection for other heavy duty applications on troughing conveyors. SBR covers provide excellent flex life and resistance to abrasion, making it a good buy for most conveyor applications.

**Temperature range:** -25° F to 225° F. **Thickness:** 15/32". **Weight:** .215 piw.

**Minimum pulley diameter:** 16". **Recommended fasteners:** #190 Solid Plate, #550 Bolt On, #R5 1/2 Rivet.

**Part Number: 20026039**





## HEAVY DUTY INDUSTRIAL / GRAIN BELT

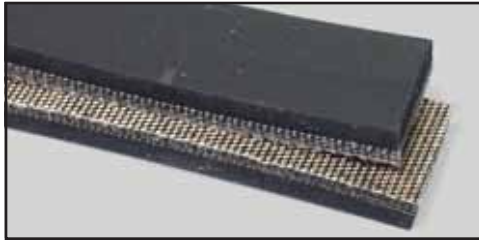

### #243 4 Ply 440 1/4 x Bare Back Grade 2

Excellent heavy duty conveyor belt with an extra thick abrasion resistant top cover. Use where impact resistance is important with slider bed conveyors, as in the logging industry de-barkers, etc. SBR cover provides excellent flex life and abrasion resistance.

**Temperature range:** -25° F to 225° F. **Thickness:** 1/2". **Weight:** .220 piw.  
**Minimum pulley diameter:** 18". **Recommended fasteners:** #190 Solid Plate, #550 Bolt On, #R5 1/2 Rivet.

**Part Number: 20027007**



### #13 4 Ply 440 1/4 x 1/16 Grade 2

Excellent heavy duty conveyor belt with extra thick abrasion resistant top cover. Often used in the aggregate industry where impact resistance is important, for example rock crushers. Belt is often used as a base belt for heavy duty custom fabrications. SBR cover provides excellent flex life and resistance to abrasion, making it a good buy for most conveyor applications.

**Temperature range:** -25° F to 225° F. **Thickness:** 9/16". **Weight:** .280 piw.  
**Minimum pulley diameter:** 20". **Recommended fasteners:** #190 Solid Plate, #550 Bolt On, #R6 Rivet.

**Part Number: 20026815**



### #246 1 Ply 440 1/4 x 1/8 Grade 2

Construction is a straight warp synthetic carcass design made especially for high resistance to cutting, snagging, and abrasion. The single ply construction offers exceptional life, low stretch, high load carrying capacity, and superior resistance to ripping and tearing.

**Temperature range:** -25° F to 225° F. **Thickness:** 9/16". **Weight:** .295 piw.  
**Minimum pulley diameter:** 20". **Recommended recessed fasteners:** #190 Solid Plate, #550 Bolt On, #R6 Rivet.

**Part Number: 20029852**



### #14A 3 Ply 600 3/8 x 3/32 Grade 2

Excellent heavy duty conveyor belt with extra thick abrasion resistant covers. Often used in mining applications requiring cut and gouge resistance. Good selection for scrap metal applications on troughing conveyors. Used in waste and recycling. SBR covers provide excellent flex life and resistance to abrasion, making it a good buy for troughing conveyor applications.

**Temperature range:** -25° F to 225° F. **Thickness:** 23/32". **Weight:** .375 piw.  
**Minimum pulley diameter:** 20". **Recommended recessed fasteners:** #1 1/2" Solid Plate, #R6 Rivet.

**Part Number: 20027210**

## GRAIN BELT



### #21 2 Ply 150 1/32 x Bare Back Moderate Oil Resistance

Excellent light duty thin conveyor belt with oil and abrasion resistant cover. Good selection for light duty use where resistance to oils is required. Used in agriculture, wood, waste, and recycling industries. MOR covers provide excellent flex life and resistance to light oil contact.

**Temperature range:** 0° F to 250° F. **Thickness:** 9/64". **Weight:** .075 piw.  
**Minimum pulley diameter:** 4". **Recommended fasteners:** #2 Hook, #125 Staple, #15 Alligator.

**Part Number: 20027200**



### #23A 2 Ply 220 1/16 x 1/16 Static Conductive Oil Resistant Fire Retardant Grain

Special compounds in this belt make it an excellent choice for handling grain and other applications requiring resistance to mineral, animal, or vegetable fats. It is also static conductive and MSHA approved for use on grain conveyors and in grain elevators where static charges must be held to minimums. Belt is flame resistant.

**Temperature range:** 0° F to 250° F. **Thickness:** 15/64". **Weight:** .095 piw.  
**Minimum pulley diameter:** 12" for conveyor / 14" for elevator. **Recommended fasteners:** #140 Solid Plate, #187 Staple, #375 Bolt On, #R5 Rivet.

**Part Number: 20021628**

10 BELT SAMPLES ARE AVAILABLE •

**#25A 3 Ply 330 1/16 x 1/16 Static Conductive Oil Resistant Fire Retardant Grain**

Excellent medium duty elevator belt with exceptional bolt retention ability. Often used on elevator legs and in applications requiring resistance to mineral, animal, or vegetable fats. Good selection for grain conveyor applications and bucket elevators. Also used where equally thick covers permit belt to be turned over for longer wear. Covers provide excellent flex life, making it a good buy for tough elevator applications.

**Temperature range:** 0° F to 250° F. **Thickness:** 17/64". **Weight:** .130 piw.  
**Minimum pulley diameter:** 16" for conveyor / 18" for elevator. **Recommended fasteners:**  
 #140 Solid Plate, #550 Bolt On, #R5 Rivet.

**Part Number: 20021630**



**#27A 3 Ply 600 1/16 x 1/16 Static Conductive Oil Resistant Fire Retardant Grain**

Excellent heavy duty elevator belt with exceptionally strong bolt retention ability. Often used on elevator legs and in applications requiring resistance to mineral, animal, or vegetable fats. Good selection for grain conveyor applications and bucket elevators. Also used where equally thick covers permit belt to be turned over for longer wear. Covers provide excellent flex life, making it a good buy for tougher elevator applications.

**Temperature range:** 0° F to 250° F. **Thickness:** 3/8". **Weight:** .195 piw.  
**Minimum pulley diameter:** 20" for conveyor / 24" for elevator. **Recommended fasteners:**  
 #140 Solid Plate, #550 Bolt On, #R5 Rivet.

**Part Number: 20021635**



**#27B 4 Ply 440 1/16 x 1/16 Static Conductive Oil Resistant Fire Retardant Grain**

Excellent heavy duty elevator belt with exceptional bolt retention ability. Often used on elevator legs and in applications requiring resistance to mineral, animal, or vegetable fats. Good selection for grain conveyor applications and bucket elevators. Also used where equally thick covers permit belt to be turned over for longer wear. Covers provide excellent flex life, making it a good buy for tough elevator applications.

**Temperature range:** 0° F to 250° F. **Thickness:** 11/32". **Weight:** .200 piw.  
**Minimum pulley diameter:** 20". **Recommended fasteners:** #190 Solid Plate, #550 Bolt On, #R5 Rivet.

**Part Number: 20021640**



**BALER BELT**

**#36 2 Ply 220 1/32 x 1/32 Baler Belt**

Popular specification for older model hay balers. Excellent fastener retention, with good impact resistance. Nylon fabric resists moisture and mildew. Special SBR compounds resist weathering and the effects ozone.

**Temperature range:** -25° F to 225° F. **Thickness:** 13/64". **Weight:** .100 piw.  
**Minimum pulley diameter:** 4". **Recommended fasteners:** 3-4 1/2 HT Hook.

**Part Number: 20021510**



**#36A 2 Ply 220 Texture x Texture Baler Belt**

Excellent gripping textured top cover belt with exceptional stretch characteristics without loss of fastener retention. Ideal choice for replacement belts on various round hay baler equipment requiring a grip top surface. Special SBR compounds resist weathering, sunlight, and the effects of sitting during long periods of no use. Special compounds in cover provide excellent flex life, making it a good buy.

**Temperature range:** -25° F to 225° F. **Thickness:** 3/16". **Weight:** .090 piw.  
**Minimum pulley diameter:** 4". **Recommended fasteners:** #3-4 1/2 HT Hook.

**Part Number: 20021515**



**#36B 3 Ply 225 Diamond Top x Mini Skim Coat Baler Belt**

Excellent profile top cover belt with exceptional stretch characteristics without loss of fastener retention. Ideal choice for replacement belts on various round hay baler equipment requiring a grip top surface. Special SBR compounds resists weathering, sunlight, and the effects of sitting during long periods of no use. Special compounds in cover provide excellent flex life, making it a good buy.

**Temperature range:** -25° F to 225° F. **Thickness:** 1/4". **Weight:** .135 piw.  
**Minimum pulley diameter:** 4". **Recommended fasteners:** #3-4 1/2 HT or #4 1/2 RHT Hooks.

**Part Number: 20029150**



## BALER / SPECIAL SERVICE BELT



### #36D 3 Ply 330 Chevron Top x Mini Skim Coat Baler Belt

Excellent gripping chevron top cover belt with exceptional stretch characteristics without loss of fastener retention. Ideal choice for replacement belts on various round hay baler equipment requiring a grip top surface. Special SBR compounds resist weathering, sunlight and the effects of sitting during long periods of no use. Special compounds in cover provide excellent flex life, making it a good buy.

**Temperature range:** -25° F to 225° F. **Thickness:** 1/4". **Weight:** .125 piw.

**Minimum pulley diameter:** 4". **Recommended fasteners:** #3-4 1/2 HT or #4 1/2 RHT Hooks.

**Part Number: 20029170**



### #37A 3 Ply 330 Texture x Texture Baler Belt

Excellent gripping textured cover belt with exceptional stretch characteristics without loss of fastener retention. Ideal choice for replacement belts on various round hay baler equipment requiring a grip top surface. Special SBR compounds resist weathering, sunlight, and the effects of sitting during long periods of no use. Special compounds in cover provide excellent flex life, making it a good buy.

**Temperature range:** -25° F to 225° F. **Thickness:** 1/4". **Weight:** .123 piw.

**Minimum pulley diameter:** 4". **Recommended fasteners:** #3-4 1/2 HT or #4 1/2 RHT Hooks.

**Part Number: 20021605**

## SPECIAL SERVICE BELT



### #24B 2 Ply 220 3/16 x 1/16 Moderate Oil Resistance

Excellent heavy duty conveyor belt with a thick oil resistant top cover. Often used in the lumber and wood chip industries, where resistance to pitch and oils is important. Belt is also used as a base belt for chevron design medium duty custom fabrications.

**Temperature range:** 0° F to 250° F. **Thickness:** 11/32". **Weight:** .200 piw.

**Minimum pulley diameter:** 12". **Recommended fasteners:** #190 Solid Plate, #550 Bolt On, #R5 Rivet.

**Part Number: 20017332**



### #26A 3 Ply 330 3/16 x 1/16 Moderate Oil Resistance

Excellent heavy duty conveyor belt with thick oil resistant top cover. Often used in the lumber and wood chip industries, where resistance to pitch and oils is important. Belt is often used as a base belt for chevron design medium duty custom fabrications.

**Temperature range:** 0° F to 250° F. **Thickness:** 13/32". **Weight:** .220 piw.

**Minimum pulley diameter:** 16". **Recommended fasteners:** #190 Solid Plate, #550 Bolt On, #R5 Rivet.

**Part Number: 20021820**



### #26B 3 Ply 330 3/16 x Bare Back Moderate Oil Resistance

Top quality heavy duty slider back belt with moderate oil resistance. Used in pan conveying applications, also found in heavy use recycling and lumber conveying applications. Can be vulcanized with cleat profiles to increase incline conveying angles.

**Temperature range:** 0° F to 250° F. **Thickness:** 11/32". **Weight:** .180 piw.

**Minimum pulley diameter:** 16". **Recommended fasteners:** #190 Solid Plate, #375 Bolt On, #R5 Rivet.

**Part Number: 20029734**



### #30A 2 Ply 220 3/16 x 1/16 Static Conductive Oil Resistant Fire Retardant MSHA

This belt has moderate oil resistant covers and conforms to specifications written by MSHA. Used in light mining operations and other applications where dusting and oily conditions may be considered hazardous.

**Temperature range:** 0° F to 250° F. **Thickness:** 3/8". **Weight:** .195 piw.

**Minimum pulley diameter:** 12". **Recommended fasteners:** #190 Solid Plate, #550 Bolt On, #R5 Rivet.

**Part Number: 20021598**

12 BELT SAMPLES ARE AVAILABLE •



**#41 2 Ply 220 3/16 x 1/16 400° MAXI-Heat**

Excellent high temperature resistant belt. Used in elevated temperature applications such as cement plants and foundries where castings and silica molding sand is separated. Special blended compounds in covers provide maximum resistance to the deteriorating effects of severe heat and baking conditions.

**Temperature range:** 400° F for 2" lumps and above, 300° F for fines and dense/baking loads.

**Thickness:** 3/8". **Weight:** .195 piw. **Minimum pulley diameter:** 12".

**Recommended fasteners:** #190 Solid Plate, #550 Bolt On, #R5 Rivet.

**Part Number: 20021199**



**#41A 2 Ply 220 3/16 x 1/16 700° SUPER-Heat**

Premium belt for higher temperature ranges. Excellent choice for clinker and foundry sand use. Provides high abrasion resistance, synthetic fabric won't mildew or rot, has good fastener retention and excellent adhesion between plies and covers. Synthetic fabric is dimensionally stable. Hybrid cover compounds provide extended life in high heat environments (up to 700° F).

**Temperature range:** 700° F for 2" lumps and above, 500° F for fines and dense/baking loads.

**Thickness:** 3/8". **Weight:** .195 piw. **Minimum pulley diameter:** 12".

**Recommended fasteners:** #190 Solid Plate, #550 Bolt On, #R5 Rivet.

**Part Number: 20021237**



**#42 2 Ply 220 3/16 x 1/16 350° Oil Resistant Hot Asphalt**

Excellent heat and oil resistant belt. Used in elevated oily temperature applications such as hot asphalt, machine oils, oil treated coal, and foundries. Special blended cover compounds provide maximum resistance to the deteriorating effects of oils and higher temperatures.

**Temperature range:** 0° F to 350° F. **Thickness:** 3/8". **Weight:** .195 piw.

**Minimum pulley diameter:** 12". **Recommended fasteners:** #190 Solid Plate, #550 Bolt On, #R5 Rivet.

**Part Number: 20021030**



**#42A 3 Ply 330 3/16 x 1/16 350° Oil Resistant Hot Asphalt**

Excellent heat and oil resistant belt with higher tension strengths. Used in elevated oily temperature applications such as hot asphalt, oily grains, machine oils, oil treated coal, and foundries. Special blended cover compounds provide maximum resistance to the deteriorating effects of oils and higher temperatures.

**Temperature range:** 0° F to 350° F. **Thickness:** 7/16". **Weight:** .215 piw.

**Minimum pulley diameter:** 18". **Recommended fasteners:** #190 Solid Plate, #550 Bolt On, #R5 Rivet.

**Part Number: 20021093**



**#177 3 Ply 330 1/4 x 1/16 400° MAXI-Heat**

Excellent high temperature resistant belt. Used in elevated temperature applications such as cement plants and foundries where castings and silica molding sand is separated. Special blended compounds provide maximum resistance to the deteriorating effects of severe heat and baking conditions. Heavy cover provides excellent flex life, abrasion, and impact resistance.

**Temperature range:** 400° F for 2" lumps and above, 300° F for fines and dense/baking loads.

**Thickness:** 1/2". **Weight:** .232 piw. **Minimum pulley diameter:** 18". **Recommended fasteners:** #190 Solid Plate, #550 Bolt On, #R5 1/2 Rivet.

**Part Number: 20026766**



**#43A 3 Ply 330 1/4 x 1/16 700° SUPER-Heat**

Premium belt where requirements include higher tensions and temperature ranges. Excellent choice for clinker and foundry sand use. Hybrid cover compounds provide extended life in high heat environments (up to 700°).

**Temperature range:** 700° F for 2" lumps and above, 500° F for fines and dense/baking loads.

**Thickness:** 1/2". **Weight:** .232 piw. **Minimum pulley diameter:** 18". **Recommended fasteners:** #190 Solid Plate, #550 Bolt On, #R5 Rivet.

**Part Number: 20026790**





## IMPRESSION TOP BELT



### #103B 2 Ply 220 Chevron Top x Bare Back

Excellent all purpose rubber incline belt. Low stretch polyester fabric contains 1/16" high continuous SBR rubber chevrons.

**Temperature range:** -40° F to 225° F. **Thickness:** 15/64". **Weight:** .130 piw.  
**Minimum pulley diameter:** 12". **Recommended fasteners:** #2 Hook, #125 Staple, #20 Alligator.

**Part Number: 20029575**



### #46 3 Ply 105 Black Roughtop x Friction Surface

Popular standard roughtop belt with rugged appearance. Often used as pulley lagging. Features a deep, nonskid hemp impression roughtop surface that enables products to be conveyed on inclines and declines. Grip impression eliminates or minimizes slide back of loads.

**Temperature range:** -25° F to 225° F. **Thickness:** 21/64". **Weight:** .130 piw.  
**Minimum pulley diameter:** 4". **Recommended fasteners:** #1 Hook, #125 Staple, #7 Alligator.

**Part Number: 20030200**



### #47 2 Ply 150 Black Roughtop x Bare Back

Popular standard roughtop belt that can be used as pulley lagging. Features a deep, nonskid hemp impression roughtop surface that enables products to be conveyed on inclines and declines. Grip impression eliminates or minimizes slide back of loads.

**Temperature range:** -25° F to 225° F. **Thickness:** 15/64". **Weight:** .120 piw.  
**Minimum pulley diameter:** 4". **Recommended fasteners:** #1 Hook, #125 Staple, #7 Alligator.

**Part Number: 20029005**

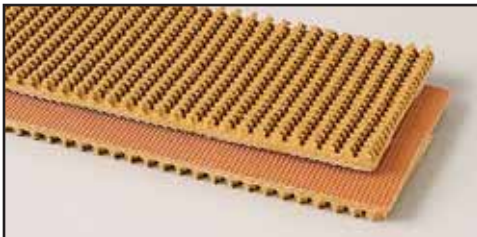

### #47A 2 Ply 150 Tan Roughtop x Bare Back

Popular non-marking roughtop belt that can be used as pulley lagging. Features a deep, nonskid hemp impression roughtop surface that enables products to be conveyed on inclines and declines. Grip impression eliminates or minimizes slide back of loads.

**Temperature range:** -25° F to 225° F. **Thickness:** 15/64". **Weight:** .120 piw.  
**Minimum pulley diameter:** 4". **Recommended fasteners:** #25LP Hook, #62 Staple, #7 Alligator.

**Part Number: 20029000**



### #48 3 Ply 135 Pure Gum Roughtop x Friction Surface

Popular standard natural gum rubber roughtop belt. The natural gum is soft with a low durometer for the highest grip which eliminates or minimizes slide back of loads. Features a deep, nonskid hemp impression roughtop surface that permits products to be conveyed on the steepest inclines and declines. Three plies of cotton-polyester fabric provide strength without sacrificing flexibility.

**Temperature range:** -40° F to 250° F. **Thickness:** 9/32". **Weight:** .100 piw.  
**Minimum pulley diameter:** 4". **Recommended fasteners:** #2 Hook, #125 Staple, #20 Alligator.

**Part Number: 20030220**



### #48A 3 Ply Polyester 150 Brown Nitrile Roughtop x Bare Back

Nitrile roughtop construction resists the effects of oil, heat, grease, and many chemical concentrations. Nitrile cover provides excellent flex life, abrasion, and impact resistance.

**Temperature range:** 0° F to 250° F. **Thickness:** 9/32". **Weight:** .105 piw.  
**Minimum pulley diameter:** 3 1/2". **Recommended fasteners:** #2 Hook, #62 Staple, #7 Alligator.

**Part Number: 20030205**

**#51A 3 Ply 135 Blue Carboxylated Nitrile Roughtop x Bare Back**

Carboxylated nitrile roughtop provides superior service with longer wear and better cut and gouge resistance than standard compounds used in general purpose roughtop specifications. Special cover compounds provide excellent flex life.

**Temperature range:** 0° F to 250° F. **Thickness:** 9/32". **Weight:** .130 piw.  
**Minimum pulley diameter:** 4". **Recommended fasteners:** #2 Hook, #125 Staple, #20 Alligator.  
**Part Number: 20030230**

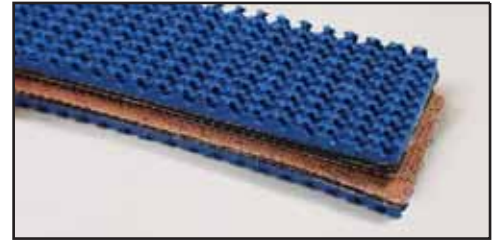

**#219 PVC 120 Green Roughtop x Friction Surface**

This roughtop textured PVC belt has a non-marking / non-skid surface that enables packages, boxes, cases, and other products to be conveyed on both inclines and declines. Uni-ply construction and PVC compounds combine properties for high traction and low stretch, with resistance to oils, greases, water, industrial chemicals, and abuse.

**Temperature range:** 20° F to 180° F. **Thickness:** 13/64". **Weight:** .100 piw.  
**Minimum pulley diameter:** 2 1/2". **Recommended fasteners:** #1 Hook, #125 Staple, #15 Alligator.  
**Part Number: 20034520**

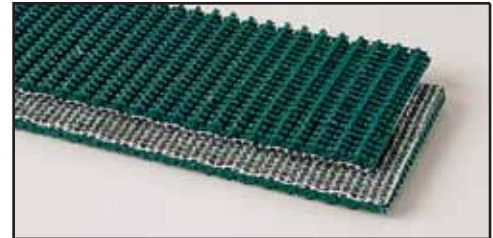

**#53 2 Ply 150 Black Wedgegrip x Bare Back**

Flexible synthetic fabric has two high strength plies. Top cover features a diamond shaped profile molded in a diagonal rib design. This specification has an unusually high coefficient of friction for conveying bagged and packaged goods up the very steepest of inclines.

**Temperature range:** -40° F to 250° F. **Thickness:** 5/16". **Weight:** .115 piw.  
**Minimum pulley diameter:** 3 1/2". **Recommended fasteners:** #2 Hook, #125 Staple, #15 Alligator.  
**Part Number: 20029009**



**#53B 2 Ply 150 Tan Wedgegrip x Bare Back**

Flexible synthetic fabric has two high strength plies. Tan top cover features a diamond shaped surface, which is non-marking and molded in a diagonal rib design with an unusually high coefficient of friction for conveying bagged and packaged goods up very steep inclines.

**Temperature range:** -20° F to 225° F. **Thickness:** 9/32". **Weight:** .100 piw.  
**Minimum pulley diameter:** 4". **Recommended fasteners:** #2 Hook, #125 Staple, #15 Alligator.  
**Part Number: 20029200**



**#54 3 Ply 105 Black Ridge Top x Friction Surface**

Profile top features 1/4" tall cleats like "m" shaped nubs with v-notch's. They provide exceptional gripping of packaged and bagged goods. This belt is an excellent choice for conveyors with declines. Rubber cover provides good durable wear characteristics.

**Temperature range:** -25° F to 225° F. **Thickness:** 21/64". **Weight:** .130 piw.  
**Minimum pulley diameter:** 3". **Recommended fasteners:** #2 Hook, #125 Staple, #20 Alligator.  
**Part Number: 20029505**



**#55A PVC 120 Black Chevron Top II Oil Resistant x Friction Surface**

The herringbone pattern of alternating rows of solid PVC chevron profiles form a cover highly capable of moving free flowing bulk solids. Materials such as grains, food stuffs, feeds and fertilizers can be carried up steep inclines.

**Temperature range:** 20° F to 180° F. **Thickness:** 1/4". **Weight:** .088 piw.  
**Minimum pulley diameter:** 2 1/2". **Recommended fasteners:** #1 Hook, #125 Staple, #7 Alligator.  
**Part Number: 20034603**





## IMPRESSION TOP BELT

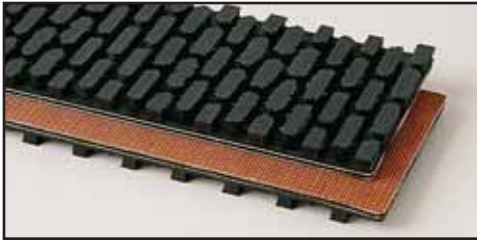

### #56 2 Ply 160 Black Steep-Lok x Bare Back

Features soft oval shaped profile nubs for gripping packages and product. Used for very steep inclines or declines. The projections prevent slip back and cushioning for all types and shapes of boxes and cartons.

**Temperature range:** -25° F to 225° F. **Thickness:** 19/64". **Weight:** .095 piw.  
**Minimum pulley diameter:** 4". **Recommended fasteners:** #1 Hook, #125 Staple, #7 Alligator.

**Part Number: 20049012**



### #61A PVC 120 Black Roughtop x Friction Surface

This medium duty textured roughtop PVC belt has a nonskid surface that enables packages, boxes, cases, and other products to be conveyed on both inclines and declines. Solid woven uni-ply construction and PVC compounds combine properties for high traction and performance, even with light oil, grease, water, and industrial chemicals present. Synthetic carcass has high strength and low stretch characteristics.

**Temperature range:** 20° F to 180° F. **Thickness:** 11/64". **Weight:** .100 piw.  
**Minimum pulley diameter:** 2 1/2". **Recommended fasteners:** #1 Hook, #125 Staple, #15 Alligator.

**Part Number: 20035506**



### #62A PVC 100 Black Bucket Top Oil Resistant x Friction Surface

This PVC profile top belt features a multitude of "bucket" projections to aggressively assist the belt in elevating bulk solids. In very wet applications, the belt can run in the opposite direction to assist in draining off fluids.

**Temperature range:** 20° F to 180° F. **Thickness:** 15/64". **Weight:** .085 piw.  
**Minimum pulley diameter:** 2". **Recommended fasteners:** #1 SP Hook, #125 Staple, #7 Alligator.

**Part Number: 20033600**



### #62B PVC 120 Black Crescent Top x Friction Surface

Crescent top profiles project from the belt surface to aggressively assist the belt in moving bulk solids. By running the belt in opposite direction, the crescent shapes can assist in draining liquids from wet products. Crescents overlap to assure a smooth quiet running on return rolls.

**Temperature range:** 20° F to 180° F. **Thickness:** 15/64". **Weight:** .085 piw.  
**Minimum pulley diameter:** 2". **Recommended fasteners:** #1 SP Hook, #62 Staple, #7 Alligator.

**Part Number: 20035525**



### #185 PVC 200 Black Crescent Top x Friction Surface

Half moon shaped profiles effectively move bulk materials up steep inclines. This is the specification of choice for fertilizers, grain, and feed conveying. Durable crescents overlap to assure a smooth quiet running on return conveyer rollers. By running the belt in opposite direction, the crescent shapes can assist in draining liquids from wet products.

**Temperature range:** 20° F to 180° F. **Thickness:** 5/16". **Weight:** .130 piw.  
**Minimum pulley diameter:** 4". **Recommended fasteners:** #187 Staple, #27 Alligator.

**Part Number: 20035530**



### #63B PVC 120 Black Z Top Oil Resistant x Friction Surface

Unique profile is designed for increased capacity and minimal slippage. Special design reduces noise levels on return idlers. Uses include tube conveying, grain, wood waste, and seed applications. Strong synthetic carcass and PVC compounds combine for high strength and durability in light oil, grease, water, and industrial chemical applications.

**Temperature range:** 20° F to 180° F. **Thickness:** 15/64". **Weight:** .090 piw.  
**Minimum pulley diameter:** 2 1/2". **Recommended fasteners:** #1 Hook, #125 Staple, #7 Alligator.

**Part Number: 20034800**

## IMPRESSION TOP / SLITTABLE CHEVRON BELT

### #242 PVC 150 Black Chevron Top II x Brushed Bottom

The chevron pattern of alternating rows form a unique pattern to effectively convey free flowing bulk solids. A very popular specification for heavy duty applications in the transportation of grains and fertilizers up steep inclines.

**Temperature range:** 20° F to 180° F. **Thickness:** 1/4". **Weight:** .110 piw.

**Minimum pulley diameter:** 3". **Recommended fasteners:** #2 Hook, #125 Staple, #20 Alligator.

**Part Number: 20034605**



### #204 PVC 150 Black Crescent Top x Brushed Bottom

Half moon shaped profiles effectively move bulk materials up steep inclines. This is the specification of choice for fertilizers, grain, and feed conveying. Durable crescents overlap to assure a smooth quiet return on conveyor rollers. By running the belt in opposite direction, the crescent shapes can assist in draining liquids from wet products.

**Temperature range:** 20° F to 180° F. **Thickness:** 1/4". **Weight:** .110 piw.

**Minimum pulley diameter:** 3". **Recommended fasteners:** #2 Hook, #125 Staple, #20 Alligator.

**Part Number: 20035527**



### #99 3 Ply Polyester 105 White Tyler Wire x Friction Surface

This specification features an impression capable of high traction on moderate inclines. Often used in bakeries, produce applications, and for handling packages and small parts. It is non-marking, oil and grease resistant. Meets FDA, is USDA accepted.

**Temperature range:** 0° F to 250° F. **Thickness:** 1/8". **Weight:** .060 piw.

**Minimum pulley diameter:** 2 1/2". **Recommended fasteners:** #1 Hook, #125 Staple, #7 Alligator.

**Part Number: 20028700**



### #102 3 Ply Polyester 135 White Nitrile Meat Cleat x Friction Surface

This belt specification is an excellent choice for moving meat and poultry products during processing at federally inspected plants. Smooth surfaces are easily cleaned. Inverted v-shaped profiles are 1/8" high and spaced evenly on 1" centers. Meets FDA requirements, is USDA accepted.

**Temperature range:** 0° F to 250° F. **Thickness:** 9/64". **Weight:** .085 piw.

**Minimum pulley diameter:** 3 1/2". **Recommended fasteners:** #2 SP Hook, #125 Staple, #15 Alligator.

**Part Number: 20028506**



### #233 2 Ply Polyester Inverted Pyramid PVC Top Cover x Bare Back

This belt is excellent for handling food and bakery products (bread dough) or in the rubber industry for the transport of unvulcanized rubber. Odorless and taste free with good resistance to fats and oils. Meets FDA requirements, is USDA accepted.

**Temperature range:** 20° F to 180° F. **Thickness:** 3/32". **Weight:** .047 piw.

**Minimum pulley diameter:** 1 1/2". **Recommended splice:** 25 LP Hook, #62 Staple, #1 Alligator.

**Part Number: 24005980**



## SLITTABLE CHEVRON BELT

### #57A 2 Ply 220 1/8 x 1/16 Durocleat Grade 2

Flexible synthetic fabric has two high strength plies. Top cover profiles are 1/4" high and 3/8" wide, cross section molded as part of the cover during manufacturing. The resulting profile is v-shaped, approximately 6" wide and staggered in rows across full width of the top cover. Excellent choice for elevating bulk materials such as surface grindings from road machinery. Commonly used as a belt replacement on asphalt scalpers, rotomills or road planers.

**Temperature range:** -25° F to 225° F. **Thickness:** 5/16" plus 1/4" x 3/8" profile. **Weight:** .210 piw. **Minimum pulley diameter:** 12". **Recommended fasteners:** #190 Solid Plate, #375 Bolt On, #R5 Rivet.

**Part Number: 20029603**





## SLITTABLE CHEVRON / PVC-RMV BELT



### #58 2 Ply 220 1/8 x 1/16 Durocleat Moderate Oil Resistance

Flexible synthetic fabric has two high strength plies. Static conductive cover profiles are 1/4" high and 3/8" wide, cross section molded as part of the cover during manufacturing. The resulting profile is v-shaped, approximately 6" wide and staggered in rows across full width of the top cover. Excellent choice for elevating bulk materials requiring oil resistance, such as wood chips.

**Temperature range:** 0° F to 250° F. **Thickness:** 5/16" plus 1/4" x 3/8" profile. **Weight:** .210 piw. **Minimum pulley diameter:** 12". **Recommended fasteners:** 190 Solid plate, #375 Bolt On, #R5 Rivet.

**Part Number: 20029601**



### #178 3 Ply 330 1/8 x 1/16 Durocleat Grade 2

The manufactured top cover profile is designed as a slittable chevron belt for heavier duty applications requiring a profiled surface for high inclines. Excellent choice for aggregate, refuse, and mineral applications.

**Temperature range:** -25° F to 225° F. **Thickness:** 3/8" plus 1/4" x 3/8" profile. **Weight:** .260 piw. **Minimum pulley diameter:** 18". **Recommended fasteners:** #190 Solid Plate, #550 Bolt On, #R5 1/2 Rivet.

**Part Number: 20029605**



### #59B 3 Ply 330 1/8 x 1/16 Durocleat Moderate Oil Resistance

The manufactured top cover profile is designed as a slittable chevron belt for heavier duty uses that requires the ability to overcome the incline limitations of standard flat surface conveyor belts. Other uses include carrying wood chips to surge piles, moving waste and demolition debris in the waste and recycling industries, and in applications where higher belt operating tensions are required. MOR compounds make belt resistant to moderately oily contaminants and the synthetic fabric makes it strong and dimensionally stable.

**Temperature range:** 0° F to 250° F. **Thickness:** 3/8" plus 1/4" x 3/8" profile. **Weight:** .250 piw. **Minimum pulley diameter:** 18". **Recommended fasteners:** #190 Solid Plate, #550 Bolt On, #R5 1/2 Rivet.

**Part Number: 20029615**



### #56B 2 Ply 220 1/8 x Bare Back Durocleat Moderate Oil Resistance

The manufactured top cover profile is designed as a slittable chevron belt for heavier duty uses that requires the ability to overcome the incline limitations of standard flat surface conveyor belts. Other uses include carrying wood chips to surge piles, moving waste and demolition debris in the waste and recycling industries, and in applications where higher belt operating tensions are required. MOR compounds make belt resistant to moderately oily contaminants and the synthetic fabric makes it strong and dimensionally stable. Comes in bare back for slider bed conveyors.

**Temperature range:** 0° F to 250° F. **Thickness:** 1/4". **Weight:** .185 piw. **Minimum pulley diameter:** 18". **Recommended fasteners:** #190 Solid Plate, #375 Bolt On, #R5 Rivet.

**Part Number: 20029602**



### #247 3 Ply 330 5/32 x Bare Back Durocleat Moderate Oil Resistance

The manufactured top cover profile is designed as a slittable chevron belt for heavier duty uses that requires the ability to overcome the incline limitations of standard flat surface conveyor belts. Other uses include carrying wood chips to surge piles, moving waste and demolition debris in the waste and recycling industries, and in applications where higher belt operating tensions are required. MOR compounds make belt resistant to moderately oily contaminants and the synthetic fabric makes it strong and dimensionally stable. Comes in bare back for slider bed conveyors.

**Temperature range:** 0° F to 250° F. **Thickness:** 9/16". **Weight:** .225 piw. **Minimum pulley diameter:** 16". **Recommended fasteners:** #190 Solid Plate, #550 Bolt On, #R5 Rivet.

**Part Number: 20029602**

## PVC - RMV BELT



### #60 2 Ply 60 Matte PVC Checkout Counter x Bare Bottom

2 plies of polyester fabric (60 lb. piw) provide adequate strength for this thin belt commonly used for retail check-out stands. Black PVC cover resists stains, cutting and gouges from rough use. Matte cover is easily cleaned while back surface has low coefficient of friction for smooth operation on slider surfaces.

**Temperature range:** 20° F to 180° F. **Thickness:** 5/64". **Weight:** .047 piw. **Minimum pulley diameter:** 2". **Recommended fasteners:** #25 LP Hook, #1 Alligator.

**Part Number: 20032710**

18 BELT SAMPLES ARE AVAILABLE •

**GOODYEAR**  
RUBBER PRODUCTS INC.

Call Toll Free: **1-866-711-4673**  
WebSales@GoodyearRubberProducts.com

**We Ship  
World Wide**

**#60A 2 Ply 100 Black RMV x Friction Surface**

Excellent all-purpose conveyor belt with a smooth 1/16" RMV top cover. Used regularly on assembly and packaging lines, and other applications requiring resistance to some oils associated with products being moved. Carcass is flexible, yet strong for stretch resistance. Cover resists oil, grease, and animal fats.

**Temperature range:** 20° F to 180° F. **Thickness:** 7/64". **Weight:** .070 piw.  
**Minimum pulley diameter:** 1 1/2". **Recommended fasteners:** #1SP Hook; #62 Staple; #7 Alligator.

**Part Number: 20032940**



**#60B 3 Ply 150 Black RMV x Friction Surface**

Excellent multiple purpose light duty conveyor belt. Smooth 1/16". Used regularly on assembly and packaging lines, and other applications requiring resistance to some oils associated with products being moved. Carcass is flexible, yet strong. Cover resists oil, grease, and animal fats.

**Temperature range:** 20° F to 180° F. **Thickness:** 1/8". **Weight:** .080 piw.  
**Minimum pulley diameter:** 3". **Recommended fasteners:** #1SP Hook, #62 Staple, #7 Alligator.

**Part Number: 20032945**



**#61A PVC 120 Black Roughtop x Friction Surface**

This medium duty textured roughtop PVC belt has a nonskid surface that enables packages, boxes, cases, and other products to be conveyed on both inclines and declines. Solid woven uni-ply construction and PVC compounds combine properties for high traction and performance, even with light oil, grease, water, and industrial chemicals present. Synthetic carcass has high strength and low stretch characteristics.

**Temperature range:** 20° F to 180° F. **Thickness:** 11/64". **Weight:** .100 piw.  
**Minimum pulley diameter:** 2 1/2". **Recommended fasteners:** #1 Hook, #125 Staple, #15 Alligator.

**Part Number: 20035506**



**#62A PVC 100 Black Bucket Top Oil Resistant x Friction Surface**

This PVC profile top belt features a multitude of "bucket" projections to aggressively assist the belt in elevating bulk solids. In very wet applications, the belt can run in the opposite direction to assist in draining off fluids.

**Temperature range:** 20° F to 180° F. **Thickness:** 15/64". **Weight:** .085 piw.  
**Minimum pulley diameter:** 2". **Recommended fasteners:** #1 SP Hook, #125 Staple, #7 Alligator.

**Part Number: 20033600**



**#62B PVC 120 Black Crescent Top x Friction Surface**

Crescent top profiles project from the belt surface to aggressively assist the belt in moving bulk solids. By running the belt in opposite direction, the crescent shapes can assist in draining liquids from wet products. Crescents overlap to assure a smooth quiet running on return rolls.

**Temperature range:** 20° F to 180° F. **Thickness:** 15/64". **Weight:** .085 piw.  
**Minimum pulley diameter:** 2". **Recommended fasteners:** #1 SP Hook, #62 Staple, #7 Alligator.

**Part Number: 20035525**



**#55A PVC 120 Black Chevron Top II Oil Resistant x Friction Surface**

The herringbone pattern of alternating rows of solid PVC chevron profiles form a cover highly capable of moving free flowing bulk solids. Materials such as grains, food stuffs, feeds and fertilizers can be carried up steep inclines.

**Temperature range:** 20° F to 180° F. **Thickness:** 1/4". **Weight:** .088 piw.  
**Minimum pulley diameter:** 2 1/2". **Recommended fasteners:** #1 Hook, #125 Staple, #7 Alligator.

**Part Number: 20034603**



## PVC-RMV BELT



### #63B PVC 120 Black Z Top Oil Resistant x Friction Surface

Unique profile is designed for increased capacity and minimal slippage. Special design reduces noise levels on return idlers. Uses include tube conveying, grain, wood waste, and seed applications. Strong synthetic carcass and PVC compounds combine for high strength and durability in light oil, grease, water, and industrial chemical applications.

**Temperature range:** 20° F to 180° F. **Thickness:** 15/64". **Weight:** .090 piw.  
**Minimum pulley diameter:** 2 1/2". **Recommended fasteners:** #1 Hook, #125 Staple, #7 Alligator.

**Part Number: 20034800**



### #242 PVC 150 Black Chevron Top II x Brushed Bottom

The chevron pattern of alternating rows form a unique pattern to effectively convey free flowing bulk solids. A very popular specification for heavy duty applications in the transportation of grains and fertilizers up steep inclines.

**Temperature range:** 20° F to 180° F. **Thickness:** 1/4". **Weight:** .110 piw.  
**Minimum pulley diameter:** 3". **Recommended fasteners:** #2 Hook, #125 Staple, #20 Alligator.

**Part Number: 20034605**



### #204 PVC 150 Black Crescent Top x Brushed Bottom

Half moon shaped profiles effectively move bulk materials up steep inclines. This is the specification of choice for fertilizers, grain, and feed conveying. Durable crescents overlap to assure a smooth quiet return on conveyor rollers. By running the belt in opposite direction, the crescent shapes can assist in draining liquids from wet products.

**Temperature range:** 20° F to 180° F. **Thickness:** 1/4". **Weight:** .110 piw.  
**Minimum pulley diameter:** 3". **Recommended fasteners:** #2 Hook, #125 Staple, #20 Alligator.

**Part Number: 20035527**



### #219 PVC 120 Green Roughtop x Friction Surface

This roughtop textured PVC belt has a non-marking / non-skid surface that enables packages, boxes, cases, and other products to be conveyed on both inclines and declines. Uni-ply construction and PVC compounds combine properties for high traction and low stretch, with resistance to oils, greases, water, industrial chemicals, and abuse.

**Temperature range:** 20° F to 180° F. **Thickness:** 13/64". **Weight:** .100 piw.  
**Minimum pulley diameter:** 2 1/2". **Recommended fasteners:** #1 Hook, #125 Staple, #15 Alligator.

**Part Number: 20034520**



### #64A PVC 100 Black Cover x Friction Surface

This thin, strong, yet flexible belt is ideal for general purpose conveying on slider bed conveyors. Used mostly on light duty conveying applications of small products. It is oil, chemical, and stretch resistant.

**Temperature range:** 20° F to 180° F. **Thickness:** 7/64". **Weight:** .065 piw.  
**Minimum pulley diameter:** 2". **Recommended fasteners:** #25 LP Hook, #62 Staple, #7 Alligator.

**Part Number: 20035498**



### #64B PVC 120 Black Friction Surface x Brushed Bottom

Proven belt for long wearing, high performance, problem free package handling applications. Friction surfaces on both top and bottom permit belt to move while package remains stopped in accumulator. Ideal for a variety of roller / slider bed applications. Characteristics include low stretch, high strength, good fastener retention, with superior rip, tear, and gouge resistance.

**Temperature range:** 20° F to 180° F. **Thickness:** 1/8". **Weight:** .050 piw.  
**Minimum pulley diameter:** 2". **Recommended fasteners:** #1 Hook, #125 Staple, #15 Alligator.

**Part Number: 20035508**

20 BELT SAMPLES ARE AVAILABLE •



**#65 PVC 120 Black Cover x Friction Surface**

Proven belt for long wearing, high performance, problem free package handling applications. Smooth coated top surface resists oil, grease, and chemicals. Ideal for a variety of roller / slider bed applications. Characteristics include low stretch, high strength, good fastener retention, with superior rip, tear, and gouge resistance.

**Temperature range:** 20° F to 180° F. **Thickness:** 9/64". **Weight:** .075 piw.  
**Minimum pulley diameter:** 2". **Recommended fasteners:** #1 Hook, #125 Staple, #15 Alligator.  
**Part Number: 20035501**



**#65A PVC 120 Black Oil Resistant x Friction Surface**

This special purpose PVC belt provides excellent service where static conductivity and increased oil resistance is required. Belt also maintains flexibility in lower temperatures and is an ideal choice for conveying oily parts.

**Temperature range:** 20° F to 180° F. **Thickness:** 9/64". **Weight:** .075 piw.  
**Minimum pulley diameter:** 2". **Recommended fasteners:** #1 Hook, #125 Staple, #15 Alligator.  
**Part Number: 20035502**



**#65B PVC 100 Black Oil Resistant x Friction Surface**

This specially compounded PVC belt has increased temperature and oil resistance, with static conductive properties. Thin, yet strong and flexible, this belt is ideal in many agricultural applications and for general purpose conveying. Used on slider bed conveyors, for handling light duty applications of small products.

**Temperature range:** 20° F to 180° F. **Thickness:** 7/64". **Weight:** .070 piw.  
**Minimum pulley diameter:** 2". **Recommended fasteners:** #1SP Hook, #62 Staple, #7 Alligator.  
**Part Number: 20035499**



**#66 PVC 120 Black Cover x Cover**

Proven belt for long wearing, high performance, problem free package handling applications. Ideal for moving pelletized fertilizers and small to medium sized product loads. Also used for a variety of roller bed and troughed applications. Characteristics include low stretch, high strength, good fastener retention, with superior rip, tear, and gouge resistance.

**Temperature range:** 20° F to 180° F. **Thickness:** 11/64". **Weight:** .090 piw.  
**Minimum pulley diameter:** 2 1/2". **Recommended fasteners:** #2 Hook, #125 Staple, #20 Alligator.  
**Part Number: 20035500**



**#66A PVC 150 Black Oil Resistant Cover x Cover**

Proven belt for long wearing, high performance, problem free material handling applications. Ideal for moving bulk materials, chemicals, fertilizers, and moderate sized product loads. Ideal for a variety of roller bed and troughed applications. Characteristics include low stretch, high strength, good fastener retention, with superior rip, tear, and gouge resistance.

**Temperature range:** 20° F to 180° F. **Thickness:** 13/64". **Weight:** .100 piw.  
**Minimum pulley diameter:** 4". **Recommended fasteners:** #3 Hook, #125 Staple, #25 Alligator.  
**Part Number: 20038199**



**#67 PVC 150 Black Cover x Friction Surface**

Very popular medium duty PVC belt proven for long wearing, high performance, and problem free material handling. Ideal for a variety of slider / roller bed applications. Accommodates fertilizers, chemicals, and bulk materials. Characteristics include low stretch, high strength, good fastener retention, with superior rip, tear, and gouge resistance.

**Temperature range:** 20° F to 180° F. **Thickness:** 11/64". **Weight:** .100 piw.  
**Minimum pulley diameter:** 3". **Recommended fasteners:** #2 Hook, #125 Staple, #20 Alligator.  
**Part Number: 20038200**





## PVC / RMV BELT



### #67A PVC 200 Black Cover x Friction Surface

Heavier duty PVC belt proven for long wearing, high performance, and problem free material handling. Regularly used in the feed and grain industries. Also popular as heavy duty package and bulk product conveyor belt for both slider and roller bed conveyors.

**Temperature range:** 20° F to 180° F. **Thickness:** 15/64". **Weight:** .117 piw. **Minimum pulley diameter:** 6". **Recommended fasteners:** #4 Hook, #187 Staple, #27 Alligator.

**Part Number: 20038207**



### #69A PVC 200 Black Oil Resistant Static Conductive Cover x Cover

Heavier duty PVC belt proven for long wearing, high performance and problem free material handling applications. Regularly used in the feed and grain industries. Also popular as heavy duty package and bulk product conveying belt for both troughed roller bed conveyors and elevator applications.

**Temperature range:** 20° F to 180° F. **Thickness:** 1/4". **Weight:** .142 piw. **Minimum pulley diameter:** 6". **Recommended fasteners:** #4 Hook, #187 Staple, #27 Alligator, #R5 Rivet.

**Part Number: 20038206**



### #69B PVC 250 Black Oil Resistant Static Conductive Cover x Cover

Commonly used for elevator belting in the feed and grain industries. Because of the low temperature, oil resistance, and static conductive qualities of this specification, it provides excellent service life in most agricultural environments. This belt won't mildew or rot, is moisture resistant, and has high bolt retention for bucket attachments.

**Temperature range:** 20° F to 180° F. **Thickness:** 5/16". **Weight:** .150 piw. **Minimum pulley diameter:** 8". **Recommended fasteners:** #140 Solid Plate, #550 Bolt On, #R5 Rivet, #35 Alligator.

**Part Number: 20038500**

## PVC ELEVATOR BELT



### #66A PVC 150 Black Oil Resistant Cover x Cover

Proven belt for long wearing, high performance, problem free material handling applications. Ideal for moving bulk materials, chemicals, fertilizers, and moderate sized product loads. Ideal for a variety of roller bed and troughed applications. Characteristics include low stretch, high strength, good fastener retention, with superior rip, tear, and gouge resistance.

**Temperature range:** 20° F to 180° F. **Thickness:** 13/64". **Weight:** .100 piw. **Minimum pulley diameter:** 4". **Recommended fasteners:** #3 Hook, #187 Staple, #25 Alligator.

**Part Number: 20038199**



### #70A PVC 200 White Oil Resistant Cover x Cover

Excellent two cover white belt for heavy duty use on conveyors with FDA requirements, such as flour milling, sugar, or bulk foods. Characteristics include low stretch, high bolt retention, and an SOR compound that is not affected by grains. Meets FDA; is USDA accepted.

**Temperature range:** 20° F to 180° F. **Thickness:** 1/4". **Weight:** .142 piw. **Minimum pulley diameter:** 6" for conveyor / 8" for elevator.

**Recommended fasteners:** #4 Hook, #187 Staple, #27 Alligator, #R5 Rivet.

**Part Number: 20038208**



### #69A PVC 200 Black Oil Resistant Static Conductive Cover x Cover

Heavier duty PVC belt proven for long wearing, high performance and problem free material handling applications. Regularly used in the feed and grain industries. Also popular as heavy duty package and bulk product conveying belt for both troughed roller bed conveyors and elevator applications.

**Temperature range:** 20° F to 180° F. **Thickness:** 1/4". **Weight:** .142 piw. **Minimum pulley diameter:** 6". **Recommended fasteners:** #4 Hook, #187 Staple, #27 Alligator, #R5 Rivet.

**Part Number: 20038206**

22 BELT SAMPLES ARE AVAILABLE •

**#69B PVC 250 Black Oil Resistant Static Conductive Cover x Cover**

Commonly used for elevator belting in the feed and grain industries. Because of the low temperature, oil resistance, and static conductive qualities of this specification, it provides excellent service life in most agricultural environments. This belt won't mildew or rot, is moisture resistant, and has high bolt retention for bucket attachments.

**Temperature range:** 20° F to 180° F. **Thickness:** 5/16". **Weight:** .150 piw.  
**Minimum pulley diameter:** 8". **Recommended fasteners:** #140 Solid Plate, #550 Bolt On, #R5 Rivet, #35 Alligator.

**Part Number: 20038500**



**#72 PVC 350 Black Oil Resistant Static Conductive Cover x Cover**

Commonly used for elevator belting in the feed and grain industries. Features low stretch, trouble-free operation, high bolt retention, resistant to grain oils, fire, moisture, mildew, and rot. Breaking strength can be measured when required for Man Lift Elevators.

**Temperature range:** 20° F to 180° F. **Thickness:** 5/16". **Weight:** .158 piw.  
**Minimum pulley diameter:** 8" for conveyors / 12" for elevators.

**Recommended fasteners:** #140 Solid Plate, #550 Bolt On, #R5 Rivet, #45 Alligator.

**Part Number: 20039000**



**#73 PVC 450 Black Oil Resistant Static Conductive Cover x Cover**

Commonly used for elevator belting in the feed and grain industries. Features low stretch, trouble-free operation, high bolt retention, resistant to grain oils, fire, moisture, mildew, and rot. Breaking strength can be measured to a certain break when required for Man Lift Elevators.

**Temperature range:** 20° F to 180° F. **Thickness:** 11/32". **Weight:** .175 piw.  
**Minimum pulley diameter:** 10" for conveyor / 14" for elevator service.

**Recommended fasteners:** #190 Solid Plate, #550 Bolt On, #R5 Rivet, #45 Alligator.

**Part Number: 20040009**



**#259 PVC 600 Black Oil Resistant Static Conductive Cover x Cover**

Commonly used for elevator belting in the feed and grain industries. Features low stretch, trouble-free operation, high bolt retention, resistant to grain oils, fire, moisture, mildew, and rot. Breaking strength can be measured to a certain break when required for Man Lift Elevators.

**Temperature range:** 20° F to 180° F. **Thickness:** 3/8". **Weight:** .191 piw.  
**Minimum pulley diameter:** 12" for conveyor / 16" for elevator service.

**Recommended fasteners:** #140 Solid Plate, #375 Bolt On, #R5 Rivet.

**Part Number: 20040015**



**WHITE FOOD BELT**

**#91 2 Ply Poly 70 White Nitrile 3/64 x Friction Surface**

Popular food belt used for USDA and FDA applications. This belt is commonly supplied as original belting by many conveyor equipment manufacturers. The thin profile can be hot water and steam cleaned. High strength polyester carcass has great dimensional stability for tracking. Excellent for meat, poultry, fish, canning, and dry bulk foods. It can be fabricated with cleats, flanges, v-guides, and other value added profiles. Meets FDA requirements; is USDA accepted.

**Temperature range:** 0° F to 250° F. **Thickness:** 3/32". **Weight:** .050 piw.

**Minimum pulley diameter:** 2". **Recommended fasteners:** #1SP Hook, #62 Staple, #7 Alligator.

**Part Number: 20028503**



**#91B 2 Ply 100 White RMV x Friction Surface**

Excellent belt for handling meat, poultry, fish, canned fruits, vegetables, and dry bulk foods. Polyester carcass is blended with vinyl compounds and remains bright after cleaning. Excellent choice on many applications where tension requirements are light to moderate. This belt can be fabricated with cleats, flanges, v-guides, and other value added profiles. Meets FDA requirements; is USDA accepted.

**Temperature range:** 20° F to 180° F. **Thickness:** 7/64". **Weight:** .056 piw.

**Minimum pulley diameter:** 1 1/2". **Recommended fasteners:** #1SP Hook, #62 Staple, #7 Alligator.

**Part Number: 20032950**



## WHITE FOOD BELT



### #91C 3 Ply 150 White RMV x Friction Surface

Excellent belt for handling meat, poultry, fish, canned fruits, vegetable, and dry bulk foods. Polyester carcass is blended with vinyl compounds and remains bright after cleaning. Excellent choice for many heavier duty belt applications requiring higher belt tensions. This belt can be fabricated with cleats, flanges, v-guides, and other value added profiles. Meets FDA requirements; is USDA accepted.

**Temperature range:** 20° F to 180° F. **Thickness:** 9/64". **Weight:** .083 piw.  
**Minimum pulley diameter:** 3". **Recommended fasteners:** #1 Hook, #125 Staple, #15 Alligator.  
**Part Number: 20032951**



### #221 Polymate 135 White RMP COS

Smooth white oil resistant cover with unique quiet running, excellent tracking, and laterally rigid non-woven carcass. Great choice for cleated profiles. FDA/USDA Approved.

**Temperature range:** 20° F to 180° F. **Thickness:** 9/64". **Weight:** .070 piw.  
**Minimum pulley diameter:** 2 1/2". **Recommended fasteners:** #1 Hook, #7 Alligator.  
**Part Number: 20028507**

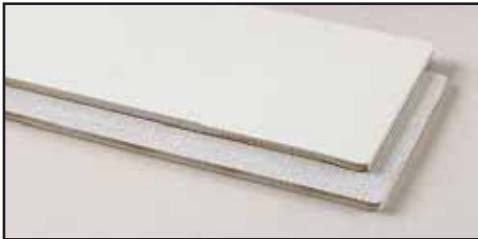

### #92 3 Ply Poly 105 White Nitrile 3/64 x Friction Surface

A thicker and stronger white nitrile food belt. Very popular with USDA and FDA applications. Generally used for more rugged food handling uses. Can be hot water or steam cleaned. High strength polyester carcass has great dimensional stability for tracking. Belt can be fabricated with cleats, flanges, v-guides, and other value added profiles. Meets FDA requirements; is USDA accepted.

**Temperature range:** 0° F to 250° F. **Thickness:** 1/8". **Weight:** .070 piw.  
**Minimum pulley diameter:** 3". **Recommended fasteners:** #1 Hook, #125 Staple, #7 Alligator.  
**Part Number: 20028505**

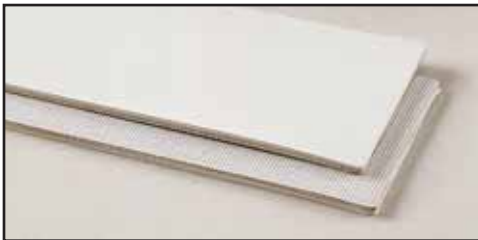

### #92A 3 Ply PNT 150 White Nitrile 3/64 x Friction Surface

Strong polyester food belt with an extra heavy cover that resists the higher impact of heavier loading. Stable polyester carcass is strong, yet flexible. Tracks well and can be fabricated with cleats, flanges, v-guides, and other value added profiles. Meets FDA requirements; is USDA accepted.

**Temperature range:** 0° F to 250° F. **Thickness:** 5/32". **Weight:** .080 piw.  
**Minimum pulley diameter:** 3 1/2". **Recommended fasteners:** #2 Hook, #125 Staple, #20 Alligator.  
**Part Number: 20028504**



### #94A PVC 100 White Cover x Mini Skim Coat

Belt provides a high service yield and is an excellent value for most food processing and harvesting uses. Fabricated cleats, flanges, v-guides, and other value added profiles can be hot welded to surfaces. Meets FDA requirements; is USDA accepted.

**Temperature range:** 20° F to 180° F. **Thickness:** 7/64". **Weight:** .050 piw.  
**Minimum pulley diameter:** 1 1/2". **Recommended fasteners:** #1SP Hook, #62 Staple, #7 Alligator.  
**Part Number: 20035400**



### #239 PVC 120 White Crescent Top x Friction Surface

Crescent half moon shaped profiles project from belt surface to effectively move packaged and bulk materials. Profile design assists in draining liquids and crescents overlap to assure smooth and quiet running on return rolls. Meets FDA requirements; is USDA accepted.

**Temperature range:** 20° F to 180° F. **Thickness:** 15/64". **Weight:** .085 piw.  
**Minimum pulley diameter:** 2". **Recommended fasteners:** #1 SP Hook, #62 Staple, #7 Alligator.  
**Part Number: 20035535**



**#95 PVC 120 White Cover x Mini Skim Coat**

Heavier duty belt that provides a high service yield and is an excellent value for most food processing and harvesting uses. Fabricated cleats, flanges, v-guides, and other value added profiles can be hot welded to surfaces. Meets FDA requirements; is USDA accepted.

**Temperature range:** 20° F to 180° F. **Thickness:** 9/64". **Weight:** .070 piw.  
**Minimum pulley diameter:** 2 1/2". **Recommended fasteners:** #1 Hook, #125 Staple, #15 Alligator.

**Part Number: 20035496**

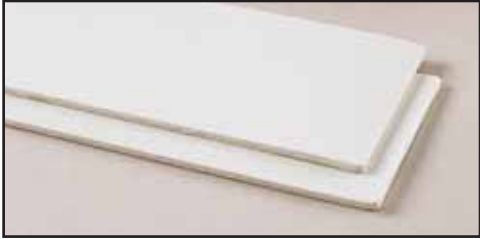

**#95B PVC 120 White Chevron Top II Oil Resistant x Mini Skim Coat**

Excellent belt for moving bulk or free flowing materials, such as grains, food stuffs, feeds, and fertilizers up steep inclines. Alternating rows of solid PVC chevrons form a herringbone pattern which returns belt smoothly and quietly. Compounds resist grease, fat, vegetable, and mineral oil exposure. Meets FDA requirements; is USDA accepted.

**Temperature range:** 20° F to 180° F. **Thickness:** 7/32". **Weight:** .072 piw.  
**Minimum pulley diameter:** 2 1/2". **Recommended fasteners:** #1 Hook, #125 Staple, #15 Alligator.

**Part Number: 20033550**



**#70A PVC 200 White Oil Resistant Cover x Cover**

Excellent two cover white belt for heavy duty use on conveyors with FDA requirements, such as flour milling, sugar, or bulk foods. Characteristics include low stretch, high bolt retention, and an SOR compound that is not affected by grains. Meets FDA; is USDA accepted.

**Temperature range:** 20° F to 180° F. **Thickness:** 1/4". **Weight:** .142 piw.  
**Minimum pulley diameter:** 6" for conveyor / 8" for elevator.  
**Recommended fasteners:** #4 Hook, #187 Staple, #27 Alligator, #R5 Rivet.

**Part Number: 20038208**



**#98 3 Ply Polyester 105 White Butyl 1/32 x Friction Surface**

This specification is designed for extreme temperature variations (-65°F to 300°F). Used on heat sealing machines, heat shrink tunnels, and other high temperature applications. This belt is also used in cold rooms and freezers where low temperatures are the norm. Meets FDA requirements; is USDA accepted.

**Temperature range:** -65° F to 300° F. **Thickness:** 7/64". **Weight:** .053 piw.  
**Minimum pulley diameter:** 1 1/2" in hot conditions, 4" in cold.  
**Recommended fasteners:** #1SP Hook, #62 Staple, #7 Alligator.

**Part Number: 20028650**

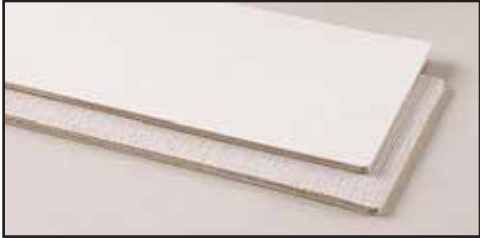

**#99 3 Ply Polyester 105 White Tyler Wire x Friction Surface**

This specification features an impression capable of high traction on moderate inclines. Often used in bakeries, produce applications, and for handling packages and small parts. It is non-marking, oil and grease resistant. Meets FDA, is USDA accepted.

**Temperature range:** 0° F to 250° F. **Thickness:** 1/8". **Weight:** .060 piw.  
**Minimum pulley diameter:** 2 1/2". **Recommended fasteners:** #1 Hook, #125 Staple, #7 Alligator.

**Part Number: 20028700**



**#102 3 Ply Polyester 135 White Nitrile Meat Cleat x Friction Surface**

This belt specification is an excellent choice for moving meat and poultry products during processing at federally inspected plants. Smooth surfaces are easily cleaned. Inverted v-shaped profiles are 1/8" high and spaced evenly on 1" centers. Meets FDA requirements, is USDA accepted.

**Temperature range:** 0° F to 250° F. **Thickness:** 9/64". **Weight:** .085 piw.  
**Minimum pulley diameter:** 3 1/2". **Recommended fasteners:** #2 SP Hook, #125 Staple, #15 Alligator.

**Part Number: 20028506**





## WHITE FOOD BELT



### #104 3 Ply Polyester 105 White Teflon x Friction Surface

Excellent belt specification for conveying wet sticky materials and uses involving spreading, gluing, and coating. Characteristics of release are the best of rubber like compounds. The strong, flexible carcass is covered with a thin teflon film. Meets FDA requirements; is USDA accepted.

**Temperature range:** 0° F to 275° F. **Thickness:** 3/32". **Weight:** .052 piw.

**Minimum pulley diameter:** 2 1/2". **Recommended fasteners:** #1SP Hook, #62 Staple, #7 Alligator.

**Part Number: 20028625**

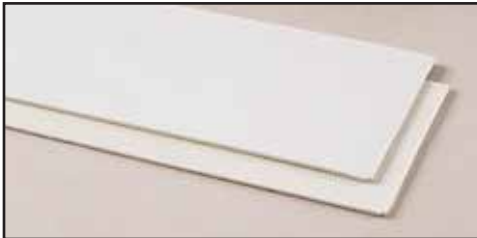

### #223 2 Ply White Urethane x IMPG Bottom Static Conductive

High quality smooth, non-adhesive urethane top cover. Ideally suited for food conveying and processing. Hard cover with good release characteristics for sticky material. Monofilament polyester carcass with anti-static properties that are excellent for flat slide bed and roller conveyors. FDA/USDA approved.

**Temperature range:** 20° F to 180° F. **Thickness:** 1/16". **Weight:** .025 piw. **Minimum pulley diameter:** 1/2". **Working tension:** 46 lbs. piw. **Recommended fasteners:** #2SP, UCM36 SP, #00 Alligator.

**Part Number: 24041040**

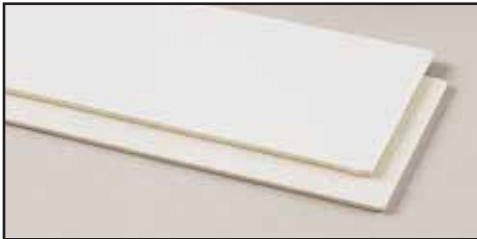

### #224 2 Ply White PVC x IMPG Bottom Static Conductive

This belt has anti-static properties and is excellent for cleated profiles. It is ideally suited for general food conveying and processing, also excellent for bottom slide bed and roller conveyors. Applications include food processing such as transporting dry, fatty, oily, and watery foodstuffs. FDA/USDA approved.

**Temperature range:** 20° F to 180° F. **Thickness:** 5/64". **Weight:** .042 piw. **Minimum pulley diameter:** 1". **Working tension at 1% tension:** .67 lbs. piw.

**Recommended fasteners:** #25 LP Hook, #62 Staple, #1 Alligator.

**Part Number: 24041010**



### #252 3 Ply 150 White RMV Cross Rigid Static Conductive x Bare Back

This specification is used for conveyor systems requiring corrugated sidewalls. Belt is a plied polyester heavy-duty thermoplastic, specially woven for transverse rigidity. It can be cleated with hot welded profiles, it resists static build up and has the superior ability to remain flat. Meets FDA requirements; is USDA accepted.

**Temperature range:** 20° F to 180° F. **Thickness:** 11/64". **Weight:** .083 piw. **Minimum pulley diameter:** 3". **Recommended fasteners:** #2 Hook, RS#125 Staple, #20 Alligator.

**Part Number: 20032953**



### #230 4 Ply 200 White RMV Cross Rigid Static Conductive x Bare Back

This specification is used for conveyor systems requiring corrugated sidewalls. It is a plied polyester heavy-duty thermoplastic belt specially woven for transverse rigidity. It can be cleated with hot welded profiles, it resists static buildup and has the superior ability to remain flat. Meets FDA requirements; is USDA accepted.

**Temperature range:** 20° F to 180° F. **Thickness:** 7/32". **Weight:** .140 piw. **Minimum pulley diameter:** 8". **Recommended fasteners:** #187 Staple, #27 Alligator.

**Part Number: 20038225**



### #67B 2 Ply PVG 220 White 1/16 x 1/16 Static Conductive

Excellent heavy duty food grade belt. Excellent for handling bulk foods such as salt, sugar, and grain. Good elevator belt with anti-static properties.

**Temperature range:** 20° F to 180° F. **Thickness:** 1/4". **Weight:** .126 piw.

**Minimum pulley diameter:** 8". **Recommended fasteners:** #4 Hook, #187 Staple, #27 Alligator, #140 Solid Plate, #375 Bolt On, #R5 Rivet.

**Part Number: 20038509**

## WHITE FOOD / PACKAGE HANDLING / LIGHT DUTY BELT

### #222 1 Ply White Urethane x IMPG Bottom Static Conductive

High quality smooth non adhesive white urethane top cover. Excellent choice for cooling tunnel belts and applications requiring a high release surface or small pulley diameters. Anti-static properties. Operates on knife edge and nose bars. FDA/USDA approved.

**Temperature range:** 20° F to 180° F. **Thickness:** 1/32". **Weight:** .015 piw.

**Minimum pulley diameter:** 1/4". **Recommended fasteners:** UCM36 XSP.

**Part Number: 24041030**



## PACKAGE HANDLING / LIGHT DUTY BELT

### #106 3 Ply 105 Black Friction Surface x Friction Surface

This belt has long been the standard for a wide variety of conveyor applications including both slider / roller bed service. It has been used on farm machinery for power transmission and a multitude of industrial uses where rubber covers are not necessary or desirable.

**Temperature range:** -40° F to 250° F. **Thickness:** 1/8". **Weight:** .057 piw.

**Minimum pulley diameter:** 3". **Recommended fasteners:** #2 SP Hook, #125 Staple, #15 Alligator.

**Part Number: 20030518**



### #107 3 Ply 105 Tan Friction Surface x Friction Surface

This belt is non-marking and a standard belt for both conveying products and transmitting power from pulley to pulley. Often used to convey wood and other building products which might otherwise be marked by black belting. Can be vulcanized to endless lengths.

**Temperature range:** -40° F to 250° F. **Thickness:** 9/64". **Weight:** .087 piw.

**Minimum pulley diameter:** 3". **Recommended fasteners:** #1 Hook, #125 Staple, #15 Alligator.

**Part Number: 20031018**



### #109 4 Ply 140 Tan Friction Surface x Friction Surface

This belt is non-marking and a standard belt for heavier duty conveying of products or transmission of power from pulley to pulley. Often used to convey lumber, plywood, and other wood products which might otherwise be easily marked by black belting. Can be vulcanized to endless lengths.

**Temperature range:** -40° F to 250° F. **Thickness:** 11/64". **Weight:** .110 piw.

**Minimum pulley diameter:** 6". **Recommended fasteners:** #2 Hook, #125 Staple, #20 Alligator

**Part Number: 20031506**



### #110 3 Ply Brown Nitrile Friction Surface x Friction Surface

A tightly woven blend of cotton and polyester fabric. Often referred to as a "sheeting belt" for a variety of light and medium weight conveying. Nitrile compounds make this construction popular for oily conditions, particularly metal parts, and for carrying tapes for folding machines. Also suitable for medium capacity transmission belt. It is oil, grease, and chemical resistant.

**Temperature range:** 0° F to 250° F. **Thickness:** 5/64". **Weight:** .037 piw.

**Minimum pulley diameter:** 3/4". **Recommended fasteners:** #25 LP Hook, #62 Staple, #1 Alligator.

**Part Number: 20032700**



### #111 5 Ply Brown Nitrile Friction Surface x Friction Surface

A tightly woven blend of cotton and polyester fabric. Often referred to as a "sheeting belt" for a variety of light and medium weight conveying. Nitrile compounds make this construction popular for oily conditions, particularly metal parts, and for carrying tapes for folding machines. Also suitable for medium capacity transmission belt. It is oil, grease, and chemical resistant.

**Temperature range:** 0° F To 250° F. **Thickness:** 7/64". **Weight:** .065 piw.

**Minimum pulley diameter:** 1 1/2". **Recommended fasteners:** #1SP Hook, #62 Staple, #7 Alligator.

**Part Number: 20032650**



## PACKAGE HANDLING / LIGHT DUTY BELT



### #203 7 Ply Brown Nitrile Friction Surface x Friction Surface

A tightly woven blend of cotton and polyester fabric. Often referred to as a "sheeting belt" for a variety of light and medium weight conveying. Nitrile compounds make this construction popular for oily conditions, particularly metal parts, and for carrying tapes for folding machines. Also suitable for medium capacity transmission belt. It is oil, grease, and chemical resistant.

**Temperature range:** 0° F To 250° F. **Thickness:** 5/32". **Weight:** .094 piw.

**Minimum pulley diameter:** 3". **Recommended fasteners:** #2 Hook, #20 Alligator.

**Part Number: 20032690**



### #195 3 Ply PNT 150 Tan Nitrile Slip Top x Friction Surface

Oil resistant carcass features a hard woven abrasion resistant bare nylon top ply. Excellent choice for stall and accumulating applications, where oil and grease are present.

**Temperature range:** 0° F to 250° F. **Thickness:** 1/8". **Weight:** .070 piw.

**Minimum pulley diameter:** 3 1/2". **Recommended fasteners:** #125 Staple, #7 Alligator.

**Part Number: 20032499**



### #113 4 Ply Tan Slip Top x Friction Surface

This belt features a hard woven abrasion resistant bare nylon top ply which is virtually frictionless. Ideal for stall operations or accumulating applications where the product must stop while the belt continues to move. Automatic packaging machinery with gates and diverter arms commonly use this specification.

**Temperature range:** -20° F to 250° F. **Thickness:** 1/8". **Weight:** .070 piw.

**Minimum pulley diameter:** 3". **Recommended fasteners:** #1 Hook, #125 Staple, #7 Alligator.

**Part Number: 20032500**



### #114 3 Ply Hot Stock and Water

Originally designed to convey uncured rubber in tire plants, it is often chosen to carry packages. The bare top surface can function for "stall" operations like other slip top belts or be run on the bottom for lowest possible friction for slider bed use.

**Temperature range:** -40° F to 250° F. **Thickness:** 9/64". **Weight:** .072 piw.

**Minimum pulley diameter:** 3 1/2". **Recommended fasteners:** #1 Hook, #125 Staple, #15 Alligator.

**Part Number: 20032550**



### #118A 4 Ply 200 Black Nitrile Friction Surface x Friction Surface

The tightly woven fabric is frictioned throughout with nitrile rubber providing a high degree of oil resistance and a good degree of cut resistance from finely broken glass, can lids, and other sharp debris found in garbage. It is also an excellent choice for metal stamping, package and luggage handling applications.

**Temperature range:** 0° F to 250° F intermittent. **Thickness:** 9/64". **Weight:** .070 piw.

**Minimum pulley diameter:** 3". **Recommended fasteners:** #1 Hook, #125 Staple, #15 Alligator.

**Part Number: 20031515**



### #118B 2 Ply 220 Tan Bare Back x Bare Back w/Black Skim

Durable high strength two ply polyester belt with a low coefficient of friction on both top and bottom sides. Ideal for handling luggage, parcels, and boxed goods.

**Temperature range:** -25° F to 225° F. **Thickness:** 5/32". **Weight:** .075 piw.

**Minimum pulley diameter:** 8". **Recommended fasteners:** #1 Hook, #125 Staple, #15 Alligator, #R2 Rivet.

**Part Number: 20030515**

28 BELT SAMPLES ARE AVAILABLE •



**#244 ATI 150 Black Urethane x Friction Surface**

Very popular medium duty urethane belt proven for long wear, high performance and problem free material handling. Ideal for a variety of roller/slider bed applications. Oil resistant, accommodates fertilizers, chemicals, bulk materials, grain and packaging.

**Temperature range:** 20° F to 180° F. **Thickness:** 3/16". **Weight:** .090 piw. **Minimum pulley diameter:** 2 1/2". **Recommended fasteners:** #125 Staple, #20 Alligator.

**Part Number: 20040550**



**#249 2 Ply Green Urethane x IMPG Static Conductive**

A thin urethane belt with excellent cut and gouge resistance, as well as good release characteristics. Excellent food and material handling specification, it is also a good choice for stall/accumulating applications. Smooth antistatic urethane cover is abrasion resistant, non-marking, and meets FDA requirements.

**Temperature range:** 20° F to 180° F. **Thickness:** 1/16". **Weight:** .025 piw. **Minimum pulley diameter:** 5/8". **Recommended fasteners:** #25 LP, Hot vulcanized finger splice, Cold bond bias step splice.

**Part Number: 24041050**



**#250 2 Ply Green PVC Roughtop x Bare Back**

This roughtop textured PVC belt has an abrasion resistant super-grip surface that enables packages, boxes, cases, and other products to be conveyed on both inclines and declines. Special low noise cover design allows the belt to run quieter on return idlers.

**Temperature range:** 20° F to 180° F. **Thickness:** 7/32". **Weight:** .077 piw. **Minimum pulley diameter:** 2 1/2". **Recommended fasteners:** #25 LP, 36LL, 62 Staple, Hot vulcanized finger splice, Cold bond bias step splice.

**Part Number: 24041070**

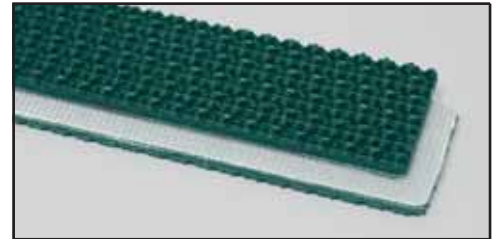

**#251 2 Ply Black PVC x Bare Back Static Conductive**

This roughtop textured PVC belt has an abrasion resistant super-grip surface that enables packages, boxes, cases, and other products to be conveyed on both inclines and declines. Special low noise cover design allows the belt to run quieter on return idlers.

**Temperature range:** 20° F to 180° F. **Thickness:** 3/32". **Weight:** .042 piw. **Minimum pulley diameter:** 1 1/2". **Recommended fasteners:** #25 LP, UCM36 SP, Hot vulcanized finger splice, Cold bond bias step splice.

**Part Number: 24041090**



**#229 2 Ply Green PVC Static Conductive x Bare Back**

All around general use conveying with low noise back side. High grade static conductive PVC cover is excellent for resistance to cuts, abrasions, vegetable oils, mineral oils, and animal fats. Excellent for flat slide or roller bed use.

**Temperature range:** 20° F to 180° F. **Thickness:** 5/64". **Weight:** .040 piw. **Minimum pulley diameter:** 1 5/8". **Working tension at 1% tension:** 86 lbs. piw. **Recommended fasteners:** #25 LP Hook, #62 Staple, #1 Alligator.

**Part Number: 24009752**

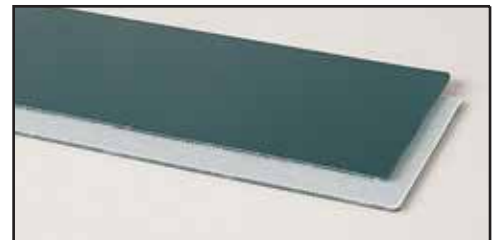

**#223 2 Ply White Urethane x IMPG Bottom Static Conductive**

High quality smooth, non-adhesive urethane top cover. Ideally suited for food conveying and processing. Hard cover with good release characteristics for sticky material. Monofilament polyester carcass with anti-static properties that are excellent for flat slide bed and roller conveyors. FDA/USDA approved.

**Temperature range:** 20° F to 180° F. **Thickness:** 1/16". **Weight:** .025 piw. **Minimum pulley diameter:** 1/2". **Working tension:** 46 lbs. piw. **Recommended fasteners:** #2SP Hook, #00 Alligator, UCM36 SP.

**Part Number: 24041040**



## THERMOPLASTIC BELT



### #224 2 Ply White PVC x IMPG Bottom Static Conductive

This belt has anti-static properties and is excellent for cleated profiles. It is ideally suited for general food conveying and processing, also excellent for bottom slide bed and roller conveyors. Applications include food processing such as transporting dry, fatty, oily, and watery foodstuffs. FDA/USDA approved.

**Temperature range:** 20° F to 180° F. **Thickness:** 5/64". **Weight:** .042

**Minimum pulley diameter:** 1". **Working tension at 1% tension:** .67 lbs. piw.

**Recommended fasteners:** #25 LP Hook, #62 Staple, #1 Alligator.

**Part Number: 24041010**



### #252 3 Ply 150 White RMV Cross Rigid Static Conductive x Bare Back

This specification is used for conveyor systems requiring corrugated sidewalls. Belt is a plied polyester heavy-duty thermoplastic, specially woven for transverse rigidity. It can be cleated with hot welded profiles, it resists static build up and has the superior ability to remain flat. Meets FDA requirements; is USDA accepted.

**Temperature range:** 20° F to 180° F. **Thickness:** 11/64". **Weight:** .083 **Minimum pulley**

**diameter:** 3". **Recommended fasteners:** #2 Hook, RS#125 Staple, #20 Alligator.

**Part Number: 20032953**



### #230 4 Ply 200 White RMV Cross Rigid Static Conductive x Bare Back

This specification is used for conveyor systems requiring corrugated sidewalls. It is a plied polyester heavy-duty thermoplastic belt specially woven for transverse rigidity. It can be cleated with hot welded profiles, it resists static buildup and has the superior ability to remain flat. Meets FDA requirements; is USDA accepted.

**Temperature range:** 20° F to 180° F. **Thickness:** 7/32". **Weight:** .140 piw.

**Minimum pulley diameter:** 8". **Recommended fasteners:** #187 Staple, #27 Alligator.

**Part Number: 20038225**



### #253 3 Ply 150 Black RMV Cross Rigid Static Conductive x Bare Back

This specification is used for deflector conveyor systems requiring corrugated sidewalls. Belt is a plied polyester heavy-duty thermoplastic, specially woven for transverse rigidity. It can be cleated with hot welded profiles, it resists static build-up and has the superior ability to remain flat.

**Temperature range:** 20° F to 180° F. **Thickness:** 11/64". **Weight:** .083 **Minimum pulley**

**diameter:** 3". **Recommended fasteners:** #2 Hook, RS #125 Staple, #20 Alligator.

**Part Number: 20032955**



### #231 4 Ply 200 Black RMV Cross Rigid Static Conductive x Bare Back

This specification is used for deflected conveyor systems requiring corrugated sidewalls. Belt is a plied polyester heavy-duty thermoplastic, specially woven for transverse rigidity. It can be cleated with hot welded profiles, resists static build-up, and has the superior ability to remain flat.

**Temperature range:** 20° F to 180° F. **Thickness:** 7/32". **Weight:** .140 piw.

**Minimum pulley diameter:** 8". **Recommended fasteners:** #187 Staple, #27 Alligator.

**Part Number: 20032957**



### #222 1 Ply White Urethane x IMPG Bottom Static Conductive

High quality smooth non adhesive white urethane top cover. Excellent choice for cooling tunnel belts and applications requiring a high release surface or small pulley diameters. Anti-static properties. Operates on knife edge and nose bars. FDA/USDA approved.

**Temperature range:** 20° F to 180° F. **Thickness:** 1/32". **Weight:** .015 piw.

**Minimum pulley diameter:** 1/4". **Recommended fasteners:** UCM36 XSP.

**Part Number: 24041030**

30 BELT SAMPLES ARE AVAILABLE •

## THERMOPLASTIC / TRANSMISSION BELT

### #60 2 Ply 60 Matte PVC Checkout Counter x Bare Back

2 plies of polyester fabric (60 lb. piw) provide adequate strength for this thin belt commonly used at retail check out stands. Black PVC cover resists stains, cutting, and gouges from rough use. Matte cover is easily cleaned while back surface has a low coefficient of friction for smooth operation on slider surfaces.

**Temperature range:** 20° F to 180° F. **Thickness:** 5/64". **Weight:** .047 piw.

**Minimum pulley diameter:** 2". **Recommended fasteners:** #1A Hook, 25 LP Hook, #1 Alligator.

**Part Number: 20032710**

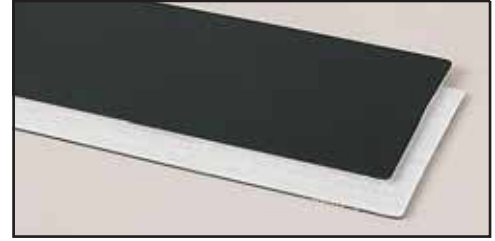

## TRANSMISSION BELT

### #240 HAM-5P

Heavy duty three ply conveying and processing belt. Used extensively in the printing and paper processing industry. Popular applications include paper roll transferring, sheeter, folders, and stackers. Belt has an anti-static green nitrile top cover with a black polyurethane bottom surface.

**Temperature range:** 0° F to 212° F. **Thickness:** 1/32". **Weight:** .014 piw.

**Minimum pulley diameter:** 5/8". **Recommended splice:** Thermofix Skived.

**Part Number: 24041195**



### #241 F-1

A popular anti-static 2 ply polyamide machine tape used in paper manufacturing and processing. Frequently use on sheeters for converting, as well as feed board and delivery tapes on printing presses, and vacuum belts for typesetting.

**Temperature range:** 0° F to 212° F. **Thickness:** 3/64". **Weight:** .021 piw.

**Minimum pulley diameter:** 1". **Recommended splice:** Thermofix Skived.

**Part Number: 24041193**



### #236 XH500-4

Extra heavy blue cover on both sides with anti-statics properties and excellent flexibility, for use on high wear drives. Used for carton and box folding and gluing, tube winding, live roller conveying. High strength pre-set nylon core. Highly abrasion, oil, and chemical resistant rubber covers, with superior resistance to flexing fatigue. Resistant to fats, oil, grease, gasoline, humidity, dryness, dust, many chemicals and solvents. Not resistant to phenol, creosol, concentrated acids.

**Temperature range:** 0° F to 250° F. **Thickness:** 5/32". **Weight:** .158 piw.

**Minimum pulley diameter:** 1 1/2". **Continuous service.** Coefficient of friction on steel is: .6 to .8.

**Recommended splice:** Thermofix skived.

**Part Number: 24005513**

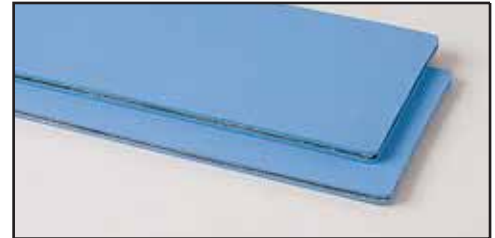

### #237 XH500-5

Extra heavy blue cover on both sides with anti-static properties and excellent flexibility, for use on high wear drives. Used for carton and box folding and gluing, tube winding, and live roller conveying. High strength pre-set nylon core. Highly abrasion, oil and chemical resistant rubber covers, with superior resistance to flexing fatigue. Resistant to fats, oil, grease, gasoline, humidity, steam, dryness, dust, many chemicals and solvents. Not resistant to phenol, creosol, or concentrated acids.

**Temperature range:** 0° F to 250° F. **Thickness:** 13/64". **Weight:** .197 piw.

**Minimum pulley diameter:** 2 1/4". **Continuous service.** Coefficient of friction on steel: .6 to .8.

**Recommended splice:** Thermofix skived.

**Part Number: 24005512**

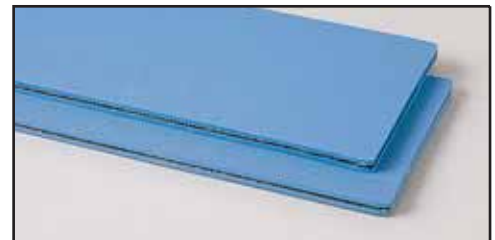

### #238 XH500-6

Extra heavy blue cover on both sides with anti-static properties and excellent flexibility, for use on high wear drives. Used for carton and box folding and gluing, tube winding, and live roller conveying. High strength pre-set nylon core. Highly abrasion, oil and chemical resistant rubber covers, with superior resistance to flexing fatigue. Resistant to fats, oil, grease, gasoline, humidity, steam, dryness, dust, many chemicals and solvents. Not resistant to phenol, creosol, or concentrated acids.

**Temperature range:** 0° F to 250° F. **Thickness:** 15/64". **Weight:** .236 piw.

**Minimum pulley diameter:** 2 1/2". **Continuous service.** Coefficient of friction on steel is: .6 to .8.

**Recommended splice:** Thermofix skived.

**Part Number: 24005514**

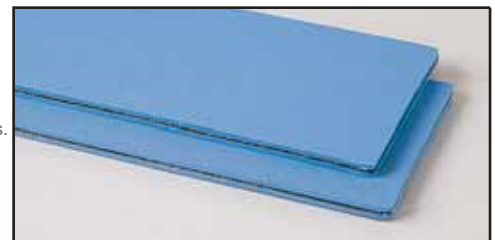



## DUROWALL™ CORRUGATED SIDEWALL

Appropriately named for its engineered durability, our Durowall™ sidewall belting consists of two corrugated sidewalls bonded to a base belt. This makes it possible to design a steep angle conveyor system that will move a far greater volume of bulk material at any angle of inclination. Depending on the types of cleats and height of the sidewalls, you can actually move product at angles up to and including 90°. With Durowall™ sidewall belting, conveyors can be designed in almost any conceivable configuration and to fit in even the most confined areas. Instead of having to transfer material from one conveyor to another, Apache's Durowall™ sidewall belting simply changes the planes of travel. Save valuable space and eliminate spillage and loss that occurs at transfer points by using corrugated Durowall™ sidewall belting.

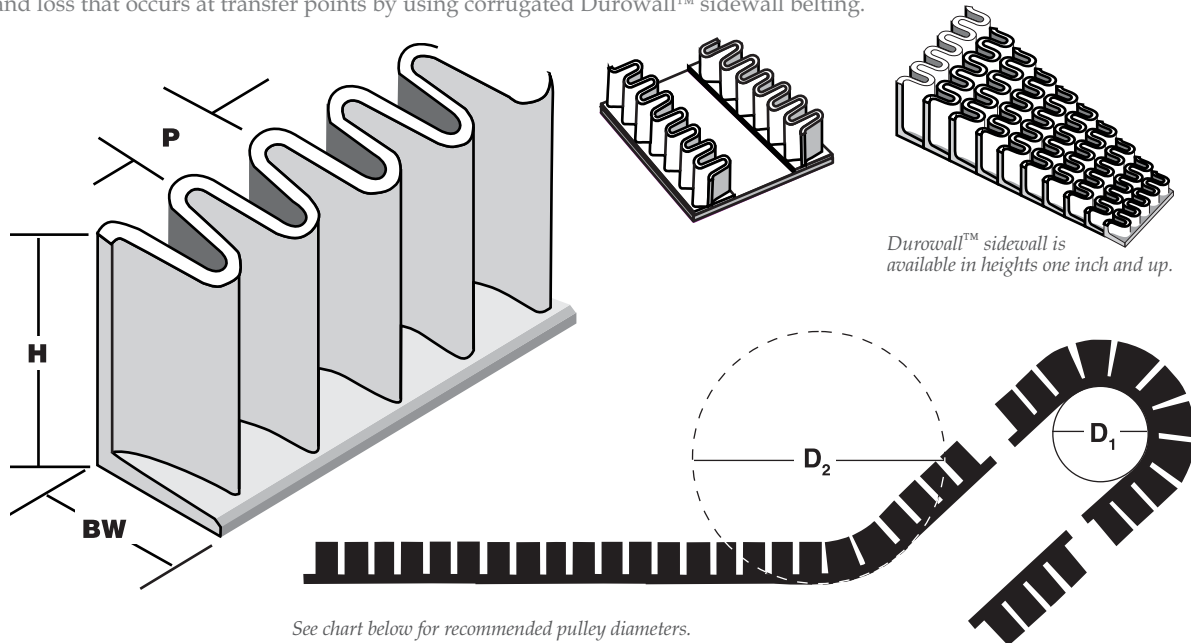

### Durowall™ Corrugated Sidewalls

Height (H)	Base Width (BW)	Pitch (P)	Weight Per Foot/Lbs	Cleat Height (Recommended)	D <sub>1</sub> (Standard Black)	D <sub>1</sub> (All Other Compounds)	D <sub>2</sub>
1"	1 1/2"	7/8"	.35	—	2"	6"	8"
1 1/2"	1 1/2"	7/8"	.50	1"	3"	6"	8"
2"	2"	1 1/4"	.80	1 1/2"	4"	8"	10"
2 1/2"	2"	1 5/8"	.95	2"	6"	10"	12"
3"	2"	1 5/8"	1.10	2 1/2"	8"	12"	16"
4"	2"	1 5/8"	1.40	3 1/2"	10"	14"	18"
5"	2"	1 5/8"	1.75	4 1/2"	12"	16"	20"
6"	2"	1 5/8"	2.20	5 1/2"	14"	20"	24"

### Durowall™ Fabric Reinforced Corrugated Sidewalls

Height (H)	Base Width (BW)	Pitch (P)	Weight Per Foot/Lbs	Cleat Height (Recommended)	D <sub>1</sub> (Standard Black)	D <sub>1</sub> (All Other Compounds)	D <sub>2</sub>
6"	3"	2 7/16"	3.0	5 1/2"	14"	20"	24"
8"	3"	2 7/16"	4.3	7 1/2"	16"	20"	32"
10"	3"	2 7/16"	5.5	9 1/2"	20"	24"	40"
12"	3"	2 7/16"	6.8	11 1/2"	24"	30"	48"

Rubber compounds available: black standard, black oil resistant, black static conducting, black (MSHA), black heat resistant (350°), and white (FDA).

Note: Larger sizes are available upon request.

## SIDEWALL CLEAT STYLES

Apache has cleat configurations that provide maximum productivity and handling efficiency, based on the type of material being carried and the angle of inclination. Straight T-Cleats are recommended on inclines up to 50°. The C or S cleats allow for larger handling capacities on inclines greater than 40°. Two piece combination cleats are also available, in which T or S paddles can be interchanged by bolting them to the cleat base. Larger cleats are bolted to the sidewalls to increase their strength and insure lasting reliability.

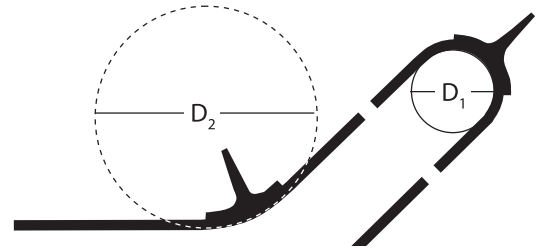

Use chart section D1 and D2 of desired cleat.

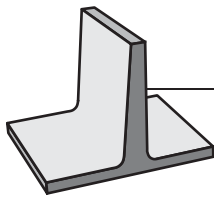

**T-Cleat**

T-Cleat	T-100	T-150	T-200	T-250	T-300	T-350	T-400
Height	1"	1.5"	2"	2.5"	3"	3.5"	4"
D <sub>1</sub>	4"	5"	6"	8"	10"	14"	14"
D <sub>2</sub>	8"	8"	10"	10"	12"	16"	18"

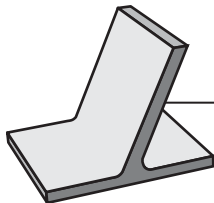

**C-Cleat**

C-Cleat	C-200	C-250	C-300	C-350	C-400	C-450
Height	2"	2.5"	3"	3.5"	4"	4.5"
D <sub>1</sub>	6"	8"	8"	10"	12"	12"
D <sub>2</sub>	10"	12"	12"	16"	16"	16"

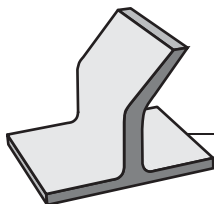

**S-Cleat**

Larger sizes available upon request.

S-Cleat	S-300	S-350	S-400	S-450	S-500	S-550	S-700	S-900
Height	3"	3.5"	4"	4.5"	5"	5.5"	7"	9"
D <sub>1</sub>	8"	11"	12"	12"	16"	16"	16"	20"
D <sub>2</sub>	12"	16"	16"	18"	20"	20"	20"	24"

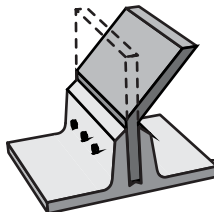

**Bolted Cleat (S or T)**

Larger sizes available upon request.

Bolted-Cleat	S/T 450	S/T 500	S/T550	S/T600	S/T700	S/T900
Height	4.5"	5"	5.5"	6"	7"	9"
D <sub>1</sub>	14"	14"	14"	14"	14"	14"
D <sub>2</sub>	20"	20"	20"	20"	20"	20"

# BELT FABRICATION DESIGNS

## DUROWALL DESIGN WORKSHEET

COPIES OF THIS DATA SHEET CAN BE USED TO HELP DETERMINE YOUR BELTING REQUIREMENTS. ACCURATE AND COMPLETE INFORMATION IS NECESSARY TO RECOMMENDED THE PROPER SOLUTION FOR YOUR APPLICATION.

Name: \_\_\_\_\_ Company Name: \_\_\_\_\_  
 City/State/Zip: \_\_\_\_\_  
 Contact: \_\_\_\_\_ Phone: \_\_\_\_\_ Fax: \_\_\_\_\_  
 Ref. Info.: \_\_\_\_\_  
 Material: \_\_\_\_\_  
 Density: \_\_\_\_\_ Size: \_\_\_\_\_ Min: \_\_\_\_\_ Max: \_\_\_\_\_  
 Surcharge: \_\_\_\_\_ Temperature: \_\_\_\_\_ Min: \_\_\_\_\_ Max: \_\_\_\_\_  
 Capacity: \_\_\_\_\_ Belt Speed (check \_\_\_ if maximum): \_\_\_\_\_  
 Width Preference: \_\_\_\_\_ Pulley Diameter (check \_\_\_ if maximum): \_\_\_\_\_  
 Oil Resistance Required? Yes \_\_\_\_\_ No \_\_\_\_\_

### EXISTING BELT SPECIFICATIONS FOR REPLACEMENT PARTS/PRICING

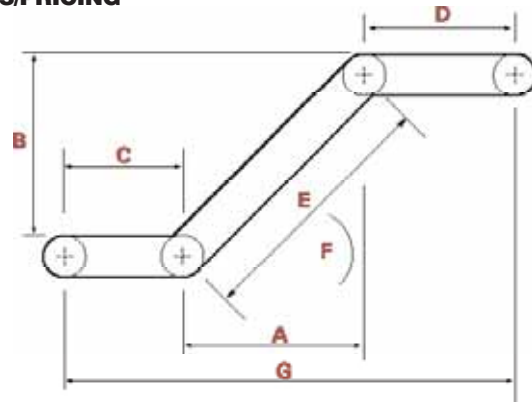
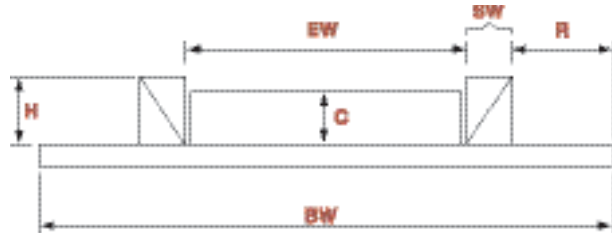

Belt Length \_\_\_\_\_  
 Belt Width (BW) \_\_\_\_\_  
 Sidewall Height (H) \_\_\_\_\_  
 Sidewall Recess (R) \_\_\_\_\_  
 Sidewall Width (SW) \_\_\_\_\_  
 Effective Width (EW) \_\_\_\_\_  
 Cleat Height (C) \_\_\_\_\_  
 Belt Type \_\_\_\_\_  
 Pulley Dia. \_\_\_\_\_  
 Defl. Dia. \_\_\_\_\_  
 Cleat Type \_\_\_\_\_  
 Cleat Spacing \_\_\_\_\_  
 Cleat Fastened to Wall? \_\_\_\_\_  
 Fasteners \_\_\_\_\_



A Horizontal of Incline \_\_\_\_\_  
 B Lift \_\_\_\_\_  
 C Infeed/or Horiz. Conv. \_\_\_\_\_  
 D Discharge \_\_\_\_\_  
 E Incline Length \_\_\_\_\_  
 F Incline Angle \_\_\_\_\_  
 G Horizontal Length \_\_\_\_\_



## TRANSMISSION DRIVE BELTS

### IN ALL WIDTHS AND LENGTHS

Available in nylon core, plied fabric, and textile cord. Can be supplied with leather or rubber covers in many different compounds. Can be mechanically laced, skived, or press and drum cured truly endless.

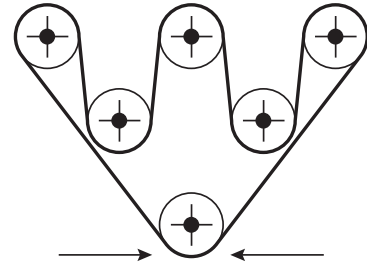

## SKIRTING - LINING MATERIAL

### ROLL STOCK SHEET RUBBER CAN BE CUT TO LENGTH

Commercial grade rubber compounds are available to satisfy many requirements and special applications. Whether it be for chutes, bin liners, or dust control flaps, Apache can recommend the proper material to resist the effects of oil, abrasion, dust, ozone, static and environmental conditions.

Roll sheet widths available up to 48".



### WEAR/ABRASION SHEET

4' x 10' Sheets

- urethane
- plain or with backing
- UHMW

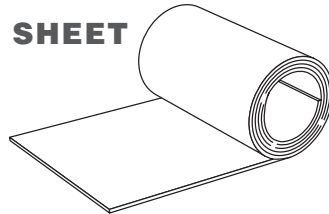

### PRE CUT "SBR" SKIRT BOARD RUBBER

- durometer: 60+/-5 • sold in 50' rolls, widths up to 48"
- resists: abrasion, moisture, cutting, and tearing

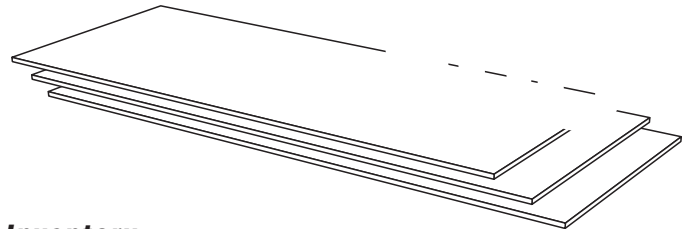

#### Standard Skirtboard Widths (inches) From Inventory

<b>1/4" Thick</b>	4"	5"	6"	8"	10"	12"
<b>Part #</b>	60002200	60002210	60002214	60002209	NA	NA
<b>Roll Weight</b>	29#	36#	44#	58#	NA	NA
<b>3/8" Thick</b>	4"	5"	6"	8"	10"	12"
<b>Part #</b>	60002220	60002230	60002240	60002249	60002250	60002251
<b>Roll Weight</b>	43#	54#	65#	86#	108#	129#
<b>1/2" Thick</b>	4"	5"	6"	8"	10"	12"
<b>Part #</b>	60002255	60002260	60002270	60002277	60002280	60002400
<b>Roll Weight</b>	57#	71#	85#	114#	142#	170#
<b>3/4" Thick</b>	4"	5"	6"	8"	10"	12"
<b>Part #</b>	NA	NA	60002426	60002428	60002430	60002429
<b>Roll Weight</b>	NA	NA	130#	174#	216#	260#
<b>1" Thick</b>	4"	5"	6"	8"	10"	12"
<b>Part #</b>	NA	NA	60002440	60002444	60002445	60002467
<b>Roll Weight</b>	NA	NA	171#	228#	285#	342#

## PULLEYS, IDLERS, AND ACCESSORIES

Apache conveyor system accessories include a variety of pulleys, idlers and components. Whether it is a belt to convey or elevate, Apache has the experience you can depend on to help keep your maintenance costs down by selecting the right components and belting for your application.

### DRUM PULLEY

High strength steel faced pulleys: available with rubber lagging for improved traction.

### WING PULLEY

Self cleaning angled gussets remove excessive build-up, improving the efficiency of your conveyor system. Wing pulleys increase traction and reduce damage and abrasion on both the belt and the pulleys. Not recommended for cleated belts.

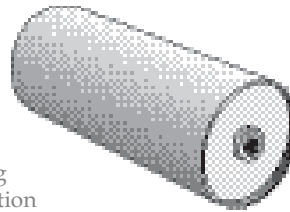

DRUM PULLEY

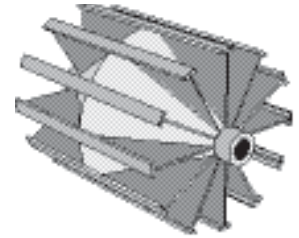

WING PULLEY

### STRIP LAGGING

Pulley lagging is installed using strips that are slid into tracks which have been bolted or welded to the pulley face.

### CUSTOM PULLEY LAGGING

Sheet rubber is bonded to the pulley face with high-tech adhesives. Ends of lagging material can be butted and filled or lapped. Patterns such as herringbone can be cut into the rubber surface.

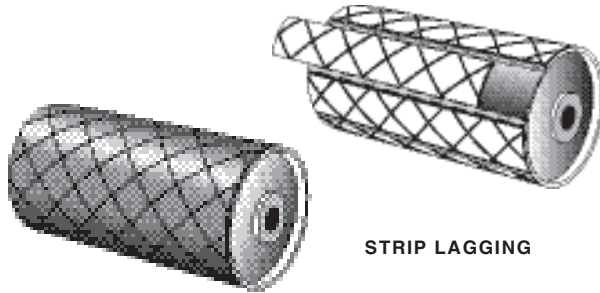

STRIP LAGGING

CUSTOM PULLEY LAGGING

### ROUGH TOP PULLEY LAGGING

For this method of pulley lagging, a long strip of rough-top is spiralled around the pulley from end to end and centered for good adhesion. The ends may be notched per sketch for neat application. Bolt or screw ends intermittently throughout. Length of strip is calculated as follows:

$$L = \frac{D \times \pi \times F}{W}$$

**L = Length (in.)**

**D = Diameter (in.)**

**$\pi = 3.1417$**

**F = Face - width of pulley (in.)**

**W = Lagging width (in.)**

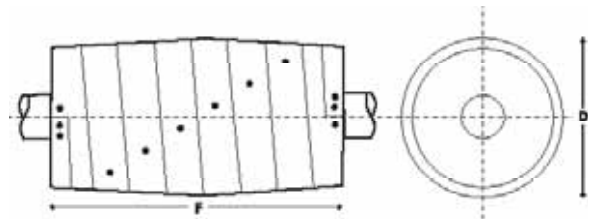

### IDLERS AND CLEANERS

Troughing and return idlers are available in a number of styles, materials, and angles for any conveyor application. Several styles of continuous belt cleaners are available to prevent material build-up and reduce down time.

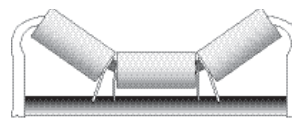

IDLER

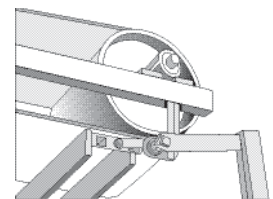

CLEANER

## CONVEYOR COVERS

### SMOOTH OR CORRUGATED FULL COVERS

Available in galvanized, steel, aluminum, stainless, and fiberglass 3 1/2', 4', 4 1/2', and 5' centers.

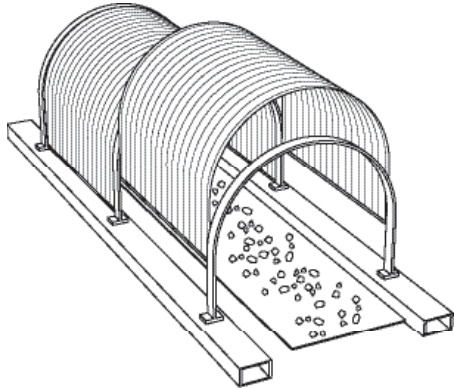

## ELEVATOR BOLTS

### STEEL, ZINC-PLATED, AND STAINLESS STEEL AVAILABLE

#### Steel Flat Head Bolts

Size	Qty./Box	Lbs./Box
1/4" x 3/4"	100	3.1
1/4" x 1"	100	3.2
1/4" x 1 1/4"	100	3.6
1/4" x 1 1/2"	100	3.9
5/16" x 1"	100	5.3
5/16" x 1 1/4"	100	5.8
5/16" x 1 1/2"	100	6.1
5/16" x 2"	100	7.3
3/8" x 1"	50	3.8
3/8" x 1 1/4"	50	4.0
3/8" x 1 1/2"	50	4.4
3/8" x 2"	50	5.0

Bolts include nuts without washers.

Also available are fanged and norway bolts styles, nylon inserted lock-nuts, and locking or flat washers.

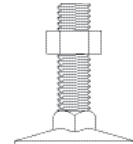

FLAT HEAD

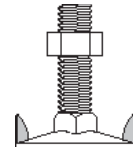

FANGED

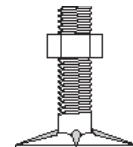

NORWAY

## ELEVATOR BUCKETS

### BUCKETS STYLES...

are available in metal, nylon, urethane, and polyethylene to handle a variety of materials. Elevator bolts are used to attach the buckets to the belt, the bolt holes can be punched in any required pattern.

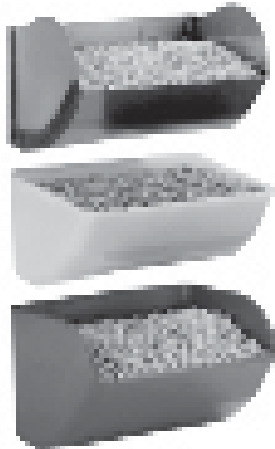

### ELEVATOR BUCKET PROJECTIONS

#### PVC Elevator Belt

Spec#	Part#	Belt Description	Max. Bucket Projection	Belt Color
66A	20038199	PVC 150 Black ORSC CBS	4"	black
69A	20038206	PVC 200 Black ORSC CBS	6"	black
69B	20038500	PVC 250 Black ORSC CBS	6"	black
70A	20038208	PVC 200 White ORSC CBS	6"	white
72	20039000	PVC 350 Black ORSC CBS	7"	black
73	20040009	PVC 450 Black ORSC CBS	8"	black
259	20040015	PVC 600 Black ORSC CBS	9"	black

#### Rubber Elevator Belt

Spec#	Part#	Belt Description	Max. Bucket Projection	Belt Color
23A	20021628	2 Ply 220 1/16 x 1/16 SCORFR Grain	6"	black
25A	20021630	3 Ply 330 1/16 x 1/16 SCORFR Grain	8"	black
27A	20021635	3 Ply 600 1/16 x 1/16 SCORFR Grain	10"	black
27B	20021640	4 Ply 440 1/16 x 1/16 SCORFR Grain	9"	black



# CUSTOM RUBBER BELT FABRICATION

## BELT SPLICING OPTIONS

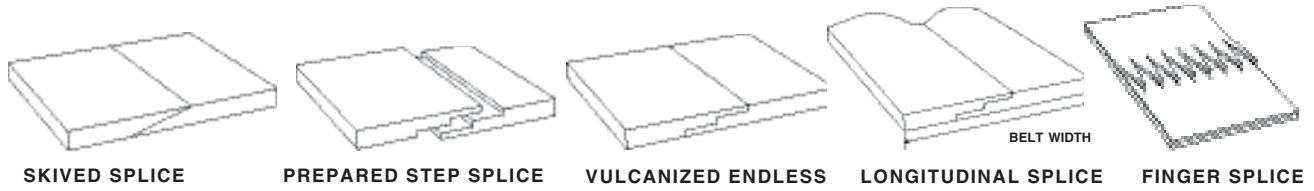

## FASTENER SPLICES



## VANNER EDGE

Vanner can be drilled and siped to improve flexibility on smaller diameter pulleys.

### Vanner Edge

#### Height

- 1/2"
- 3/4"
- 1"
- 1 1/2"
- 2"
- 2 1/2"
- 3"

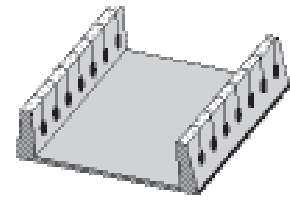
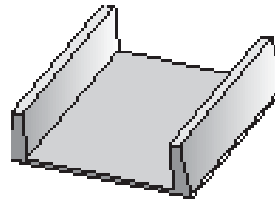

## STANDARD V-GUIDES

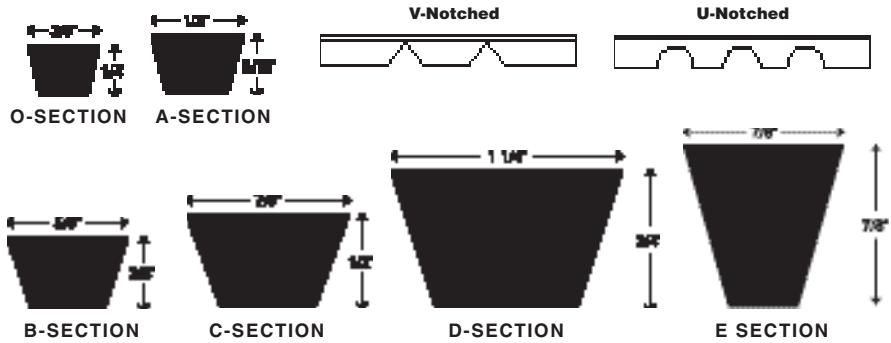

## MINIMUM RECOMMENDED PULLEY DIAMETERS

Manufacturer's recommended pulley diameter for each belt specification should be used if larger than those listed below.

### Standard Cleats

Height	Pulley Dia.
1"	4"
1 1/2"	5"
2"	6"
2 1/2"	8"
3"	10"

### Heavy Duty Cleats

Height	Pulley Dia.
1"	5"
1 1/2"	8"
2"	10"
3"	12"
4"	14"
5"	18"
6"	18"

### Square Cleats

Height	Pulley Dia.
3/8" x 3/8"	3"
1/2" x 1/2"	4"
3/4" x 3/4"	8"
1" x 1"	10"

### Vanner Edges

Height	Solid	Drilled/Siped
1/2"	9"	6"
1"	10"	6"
1 1/2"	16"	8"
2"	18"	12"
2 1/2"	20"	12"
3"	24"	16"

# FLEXCO FASTENER MATERIAL SELECTION GUIDE

STEEL • RUSTALLOY • PROMAL • EVERDUR • MEGALLOY • STAINLESS STEEL

## Product Selection Overview

Fastener Material:

Fastener Material:	CHARACTERISTICS					AVAILABILITY										
	Abrasion Resistance	Chemical Resistance	Rust Resistance	Magnetic	Spark-Free	Flexco® Bolt Solid Plate	Flexco® Rivet Solid Plate	Flexco® Bolt Hinged	Flexco® Rivet Hinged	Alligator® Staple	Alligator® Lacing	Alligator® Rivet	Wire Hook	Spiral Lace	Alligator® Plastic	
Galvanized Steel	Good	Poor	Fair	Yes	No	•	•	•	•	•	•				•	
400 Series Stainless Steel	Good	Fair to Good	Good	Yes	No		•								•	
300 Series Stainless Steel	Good	Good to Excellent	Excellent	No	No	•		•	•	•	•	•	•			
MegAlloy®	Excellent	Poor	Poor	Yes	No	•	•	•		•						
RustAlloy®	Good	Good	Good	Yes	No				•							
Everdur	Poor	Poor	Poor	No	Yes	•	•	•								
Promal	Excellent	Good	Good	Yes	No	•										
Rubber-Coated Steel	Good to Excellent	Poor	Poor	Yes	No	•										
High Tensile Steel	Good to Excellent	Fair	Good	Yes	No										•	
Rectangular High Tensile Steel	Excellent	Fair	Good	Yes	No										•	
Monel® 400	Fair	Excellent	Excellent	Slightly	No										•	
Inconel® 600	Fair	Excellent	Excellent	No	No										•	
Phosphor Bronze	Good	Poor	Good	No	Yes										•	
Hastelloy C-22	Good	Excellent	Excellent	No	No										•	
Black Oxide	Good	Poor	Fair	Yes	No										•	
Non-Metallic	Poor	Fair	N/A	No	Yes											•



**BOLT SOLID PLATE**



**RIVET SOLID PLATE**



**BOLT HINGE**



**RIVET HINGE**



**STAPLE**



**LACING**



**RIVET**



**WIRE HOOK**



**SPIRAL LACE**



**PLASTIC**

## CUSTOM FABRICATION

### HOT VULCANIZED

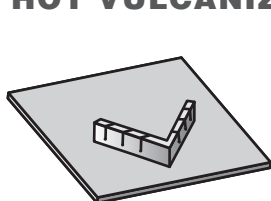

**Roofing Cleat**

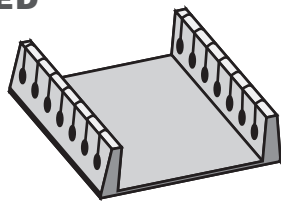

**Drilled and Siped**

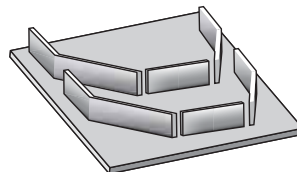

**Special Cleats**

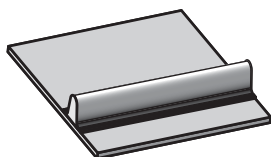

**Heavy Duty Beefy Cleat**

Height
5/8"
1"
1 1/2"
2"
3"
4"
5"
6"

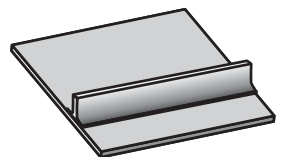

**Standard T-Cleat**

Height
3/4"
1"
1 1/2"
2"
2 1/2"
3"

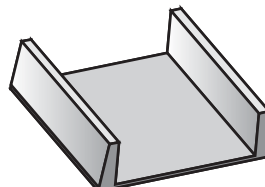

**Vanner Edge**

Height
1/2"
3/4"
1"
1 1/2"
2"
2 1/2"
3"

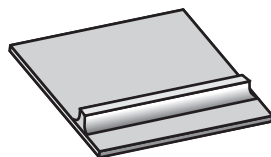

**Square Cleat**

Height
3/8" x 3/8"
1/2" x 1/2"
3/4" x 3/4"
1" x 1"

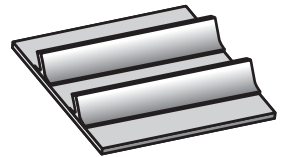

**Scoop Cleat**

*Cold vulcanized*

Height
3"
3 1/2"
4"
4 1/2"

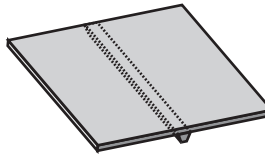

**V-Guides**

Size
A
O
B
C
D
E

### COMMON NOTCHING OPTIONS

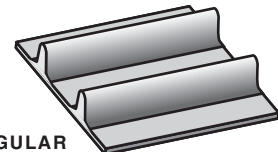

**REGULAR**  
*not notched*

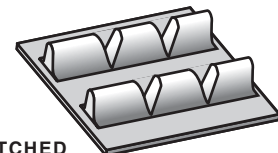

**NOTCHED**

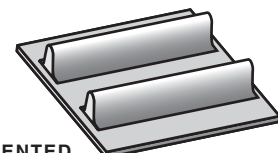

**INDENTED**

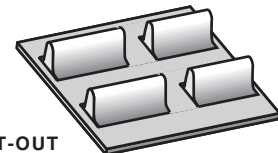

**CUT-OUT**

### APPLICATIONS:

Apache's know-how brings you cleats, vanner edges, and v-guides in a variety of designs, each of which is engineered for the maximum performance of the material being conveyed. All are hot vulcanized to the base belt.

- STAGGERED, SPACED OR NOTCHED, APACHE'S UNIQUE VULCANIZING METHODS ASSURE YOU OF A PROFESSIONALLY FABRICATED BELT.
- FABRICATION IS AVAILABLE ON NUMEROUS INDUSTRIAL AND FOOD GRADE BELTS.
- BLACK COMPOUNDS AVAILABLE ARE: STANDARD BLACK, MSHA, OIL, AND HEAT RESISTANT.
- WHITE COMPOUNDS ARE OIL AND FAT RESISTANT (FDA/USDA).
- CORRUGATED SIDEWALL IS FABRICATED ON STANDARD OR CROSS-RIGID CONSTRUCTED BELTING.



# CUSTOM THERMOPLASTIC BELT FABRICATION

STANDARD BLACK OR FDA-USDA APPROVED WHITE

## T-Cleats

Permanently bonded with the hot weld system

Height	1"	1 1/2"	2"	3"	4"
Pulley Dia. (min)	4"	5"	5"	8"	10"

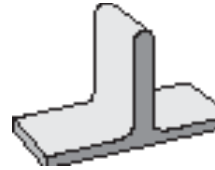

STANDARD T CLEAT

1/2" thru 3"



BEEFY STYLE CLEAT

3/4" thru 4"

## Square Cleats

Permanently bonded with the hot weld system - black or white

Sizes:	1/2" x 1/2"	3/4" x 3/4"
--------	-------------	-------------

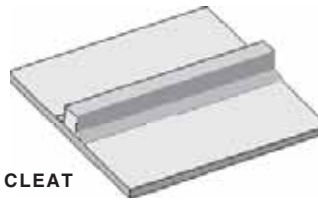

SQUARE CLEAT

## Gum Drop Flanges

Flanges white or black

Height	1/2"	3/4"	1"
Pulley Dia. (min)	5"	6"	10"

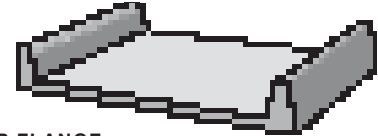

GUM DROP FLANGE

## Angle Cleats

PVC angle cleats

Dimensions	Base	Top	Height	Pulley Dia. (min)
	1 3/4"	1/4"	1 1/2"	6"
	1 3/4"	1/4"	2"	6"
	1 3/4"	1/4"	3"	8"

ANGLE CLEAT

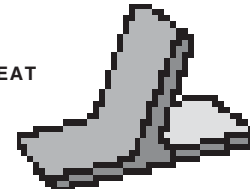

## BELT GUIDES

### V-GUIDES

PVC guides are available in white or black, and special APC belt for accumulating package conveyors [4" wide PVC 120 (cover one side)] with A or modified A section v-guides on bottom.

Dimensions	Size	Base	Top	Height	Pulley Dia. (min)
	O	3/8"	1/4"	1/4"	3" std. / 2" ntdc
	Mod A	1/2"	3/8"	3/16"	3" std.
	A	1/2"	5/16"	5/16"	4" std. / 3" ntdc
	B	5/8"	3/8"	3/8"	6" std. / 5" ntdc
	C	7/8"	1/2"	1/2"	8" std. / 7" ntdc



V-Notched



U-Notched

### METRIC V-GUIDES



## POPULAR INDUSTRIAL PATTERNS

OVER 100 OTHER CUSTOM PATTERNS AVAILABLE

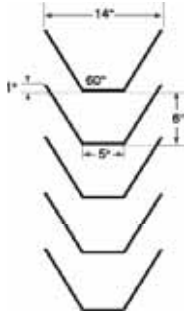

**Template #8**  
1/2" x 1/2" Square  
U-Shaped Cleats

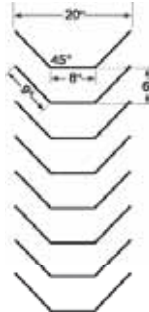

**Template #8A**  
1/2" x 1/2" Square  
U-Shaped Cleats



**Template #8B**  
1/2" x 1/2" Square  
U-Shaped Cleats



**Template #32**  
3/8" x 3/8" Closed  
Chevrons to 28" Wide

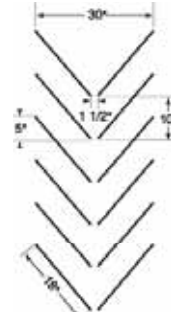

**Template #40**  
1/2" x 1/2" Square  
Chevron

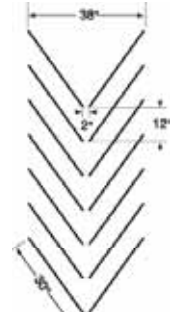

**Template #6**  
1/2" x 1/2" Square  
Chevron

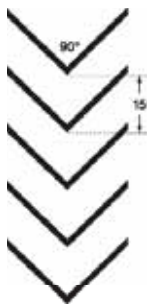

**Template #34**  
Closed 90° Chevron  
Leading and trailing edges  
beveled for return rollers



**Template #35**  
1/2" x 1/2" Square  
30" to 54"

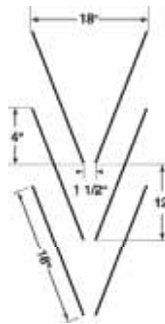

**Template #38**  
1/2" x 1/2" Square  
Chevron

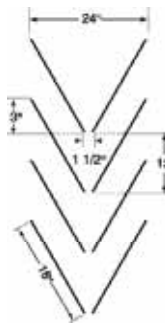

**Template #39**  
1/2" x 1/2" Square  
Chevron

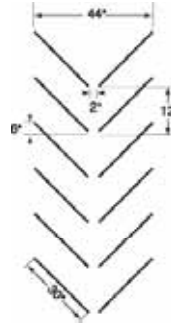

**Template #36**  
1/2" x 1/2" Rect. Cleats  
for 44" or Wider Belts

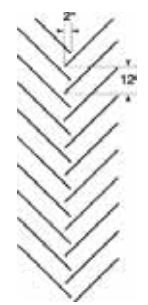

**Template #37**  
1/2" x 1/2" Square  
Herringbone 12" to 44"

## SLITTABLE BELTING

POPULAR FACTORY  
MANUFACTURED  
PROFILES



**CHEVRON TOP**



**BUCKET TOP**



**CRESCENT TOP**



**DUROCLEAT™  
(Rubber V-Top)**

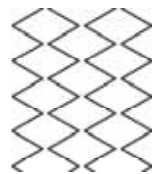

**Z TOP**



**CONTINUOUS  
CHEVRON**

### CONSTRUCTIONS:

Apache matches the appropriate belt and cleat specifications to meet your application requirements. Standard or special belt and cleat compounds are utilized to increase productivity and extend service life.

### CHEVRON DESIGNS:

Chevron patterns carry a variety of materials up much steeper inclines than a standard belt. Loose and wet or dry materials are moved quickly from the loading points. Chevron patterns are available with either closed or open centers (for drainage).

### APPLICATIONS:

Apache Chevron cleated belt can be found in limitless applications. Common uses are asphalt milling, sand and gravel, wood chips, coal mining, waste management, tub grinders, and loading/unloading of barges and rail cars.

**Contact Apache Customer Service for recommendations on your specific application.**

## CUT PARTS FOR INDUSTRIAL APPLICATIONS

*Apache offers a wide range of cut parts and sealing materials for a myriad of applications. Apache also offers die cut parts, water jetting & laser cutting.*

### **Cut parts include:**

- Baffles
- Draper Material
- Curtains
- Impact Pads
- Skirting
- Flashing
- Insulation
- Seals
- Bearing Pads
- Spacers
- Shields
- Gaskets
- Guards
- Hopper/Bin Liners
- Mud Flaps

### **A large variety of material is used, such as:**

- Pure gum sheet
- Cloth insulated sheet
- Butyl sheet
- Diaphragm sheet
- Neoprene sheet
- White nitrile sheet
- Hypalon® sheet
- Masticated rubber
- PVC belting
- Industrial belting
- Composites
- Fibre
- Black & Red SBR sheet
- Viton® rubber
- Teflon sheet
- Silicone sheet
- Nitrile sheet
- Felt
- Open & closed cell sponge
- UHMW
- TIVAR
- Urethane
- White food grade belting

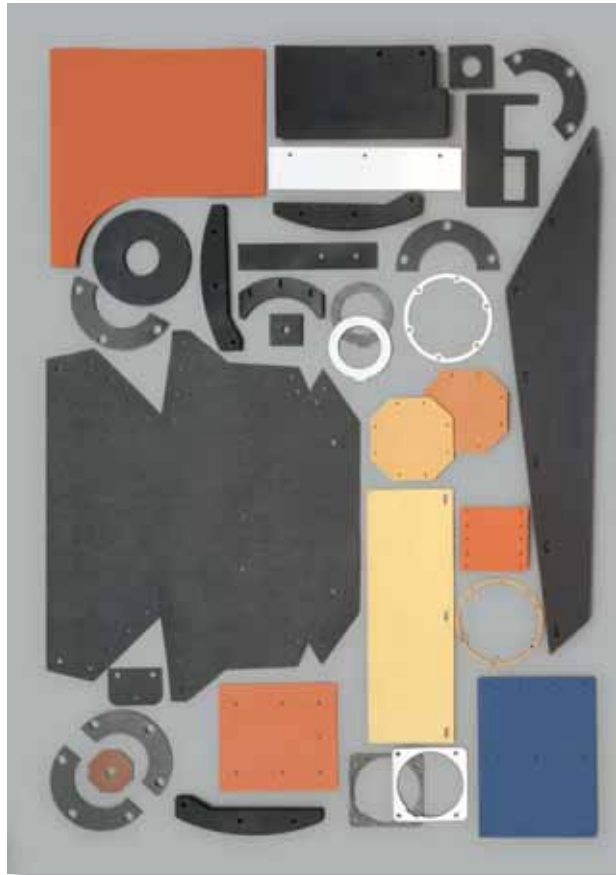



**GOODYEAR**  
RUBBER PRODUCTS INC.

**Call Toll Free: 1-866-711-4673**

[WebSales@GoodyearRubberProducts.com](mailto:WebSales@GoodyearRubberProducts.com)

**We Ship  
World Wide**

**GOODYEAR**  
RUBBER PRODUCTS INC.

**Call Toll Free: 1-866-711-4673**

[WebSales@GoodyearRubberProducts.com](mailto:WebSales@GoodyearRubberProducts.com)

**We Ship  
World Wide**

## BELT SPECIFICATION CHART

Spec#	Part#	Description	Plies	Color	Overall Thickness	Covers
<b>INDUSTRIAL BELT</b>						
#1	20027202	2 Ply 150 1/32 x BB GR2	2	black	5/32"	SBR
#2	20027301	2 Ply 150 1/32 x 1/32 GR2	2	black	13/64"	SBR
#2A	20026910	2 Ply 150 1/16 x BB GR2	2	black	3/16"	SBR
#3	20000010	2 Ply 150 1/8 x 1/32 GR2	2	black	1/4"	SBR
#4	20003990	2 Ply 150 1/8 x 1/16 GR2	2	black	9/32"	SBR
#6A	20029525	2 Ply 220 1/8 x BB GR2	2	black	1/4"	SBR
26C	20029690	2 Ply 220 1/8 x BB MOR	2	black	1/4"	SBR
#8	20013600	2 Ply 220 1/8 x 1/16 GR2	2	black	5/16"	SBR
#9	20017500	2 Ply 220 3/16 x 1/16 GR2	2	black	11/32"	SBR
#10A	20029655	3 Ply 225 1/16 x BB GR2	3	black	7/32"	SBR
<b>HEAVY DUTY INDUSTRIAL BELT</b>						
#11	20023005	3 Ply 330 3/16 x 1/16 GR2	3	black	13/32"	SBR
#12	20026039	3 Ply 330 1/4 x 1/16 GR2	3	black	15/32"	SBR
#243	20027007	4 Ply 440 1/4 x BB GR2	4	black	1/2"	SBR
#13	20026815	4 Ply 440 1/4 x 1/16 GR2	4	black	9/16"	SBR
#246	20029852	1 Ply 440 1/4 x 1/8 GR2	1	black	9/16"	SBR
#14A	20027210	3 Ply 600 3/8 x 3/32 GR2	3	black	23/32"	SBR
<b>GRAIN BELT</b>						
#21	20027200	2 Ply 150 1/32 x BB MOR	2	black	9/64"	Nitrile Blend
#23A	20021628	2 Ply 220 1/16 x 1/16 SCORFR Grain	2	black	15/64"	Nitrile Blend
#25A	20021630	3 Ply 330 1/16 x 1/16 SCORFR Grain	3	black	17/64"	Nitrile Blend
#27A	20021635	3 Ply 600 1/16 x 1/16 SCORFR Grain	3	black	3/8"	Nitrile Blend
#27B	20021640	4 Ply 440 1/16 x 1/16 SCORFR Grain	4	black	11/32"	Nitrile Blend
<b>BALER BELT</b>						
#36	20021510	2 Ply 220 1/32 x1/32 Baler Belt	2	black	13/64"	SBR
#36A	20021515	2 Ply 220 Tex x Tex Baler Belt	2	black	13/16"	SBR
#36B	20029150	3 Ply 225 Diamond Top x MSK Baler Belt	3	black	1/4"	SBR
#36D	20029170	3 Ply 330 Chevron Top x MSK Baler Belt	3	black	1/4"	SBR
#37A	20021605	3 Ply 330 Tex x Tex Baler Belt	3	black	1/4"	SBR
<b>SPECIAL SERVICE BELT</b>						
#24B	20017332	2 Ply 220 3/16 x 1/16 MOR	2	black	11/32"	Nitrile Blend
#26A	20021820	3 Ply 330 3/16 x 1/16 MOR	3	black	13/32"	Nitrile Blend
#26B	20029734	3 Ply 330 3/16 x BB MOR	3	black	11/32"	Nitrile Blend
#30A	20021598	2 Ply 220 3/16 x 1/16 SCORFR MSHA	2	black	3/8"	Nitrile Blend
#41	20021199	2 Ply 220 3/16 x 1/16 400° MAXI-Heat	2	black	3/8"	EPDM
#41A	20021237	2 Ply 220 3/16 x 1/16 700° SUPER-Heat	2	black	3/8"	EPDM
#42	20021030	2 Ply 220 3/16 x 1/16 350° ORS-HMB	2	black	3/8"	Nitrile
#42A	20021093	3 Ply 330 3/16 x 1/16 350° ORS-HMB	3	black	7/16"	Nitrile
#177	20026766	3 Ply 330 1/4 x 1/16 400° MAXI-Heat	3	black	1/2"	EPDM
#43A	20026790	3 Ply 330 1/4 x 1/16 700° SUPER-Heat	3	black	1/2"	EPDM
<b>IMPRESSION TOP BELTS</b>						
103B	20029575	2 Ply 220 Chevron Top x BB	2	black	15/64"	SBR
#46	20030200	3 Ply 105 Black RT x FS	3	black	21/64"	SBR
#47	20029005	2 Ply 150 Black RT x BB	2	black	15/64"	SBR
#47A	20029000	2 Ply 150 Tan RT x BB	2	tan	15/64"	SBR
#48	20030220	3 Ply 135 Pure Gum RT x BB	3	tan	9/32"	Natural Rubber
#48A	20030205	3 Ply Poly 150 Brown Nitrile RT x BB	3	brown	9/32"	Nitrile
#51A	20030230	3 Ply 135 Blue Carboxylated Nitrile RT x BB	3	blue	9/32"	Nitrile
#219	20034520	PVC 120 Green RT x FS	1	green	13/64"	PVC
#53	20029009	2 Ply 150 Black Wedgegrip x BB	2	black	5/16"	Natural Rubber
#53B	20029200	2 Ply 150 Tan Wedgegrip x BB	2	tan	9/32"	SBR
#54	20029505	2 Ply 105 Black Nitrile Top x FS	2	black	15/64"	SBR



Working Tension PIW	Temp Range	Minimum Pulley Dia	Weight PIW	Maximum Roll Width	FDA USDA	Flexco #	Clipper #	DESCRIPTION ABBREVIATION KEY
150#	-25°F to 225°F	4"	.075	72"		15, 125	2	
150#	-25°F to 225°F	6"	.085	72"		187, 25	3	BB = Bare Back
150#	-25°F to 225°F	6"	.105	72"		20, 125	2	
150#	-25°F to 225°F	8"	.138	84"		140, 187, 375, R2		Brush = Brushed Bottom
150#	-25°F to 225°F	10"	.154	72"		140, 375, R2		
220#	-25°F to 225°F	10"	.145	72"		140, 187, 375, R2		C = Conveyor
220#	0°F to 250°F	10"	.150	72"		140, 187, 375, R2		
220#	-25°F to 225°F	10"	.167	84"		140, 550, R5		CBS = Cover Both Sides
220#	-25°F to 225°F	12"	.195	84"		190, 550, R5		
225#	-25°F to 225°F	8"	.122	72"		25, 187, R2	2	CD = Cold
								CR = Cross Rigid
330#	-25°F to 225°F	16"	.205	84"		190, 550, R5 <sup>1/2</sup>		
330#	-25°F to 225°F	16"	.215	84"		190, 550, R5 <sup>1/2</sup>		CT II = Chevron Top II
440#	-25°F to 225°F	18"	.220	90"		190, 550, R5 <sup>1/2</sup>		
440#	-25°F to 225°F	20"	.280	84"		190, 550, R6		E = Elevator
440#	-25°F to 225°F	20"	.295	60"		190, 550, R6		
600#	-25°F to 225°F	20"	.375	84"		1 <sup>1/2</sup> , R6		FR = Fire Retardant
								FS = Friction Surface
150#	0°F to 250°F	4"	.075	72"		125, 15	2	
220#	0°F to 250°F	12c, 14e	.095	72"		140, 187, 375, R5		GR 2 = Grade 2 (SBR)
330#	0°F to 250°F	16c, 18e	.130	72"		140, 550, R5		
600#	0°F to 250°F	20c, 24e	.195	72"		140, 550, R5		H = Hot
440#	0°F to 250°F	20"	.200	72"		190, 550, R5		IMPG = Impregnated
								MOR = Moderate Oil Resistance
220#	-25°F to 225°F	4"	.100	60"			3-4 <sup>1/2</sup> ht	
220#	-25°F to 225°F	4"	.090	60"			3-4 <sup>1/2</sup> ht	
225#	-25°F to 225°F	4"	.135	60"			3-4 <sup>1/2</sup> ht, 4 <sup>1/2</sup> ht	MRT = Mini Roughtop
330#	-25°F to 225°F	4"	.125	60"			3-4 <sup>1/2</sup> ht, 4 <sup>1/2</sup> ht	
330#	-25°F to 225°F	4"	.123	60"			3-4 <sup>1/2</sup> ht, 4 <sup>1/2</sup> ht	MSHA = Mine Safety Health Act
								MSK = Mini Skim Coat
220#	0°F to 250°F	12"	.200	72"		190, 550, R5		
330#	0°F to 250°F	16"	.220	72"		190, 550, R5		OR = Oil Resistant
330#	0°F to 250°F	16"	.180	72"		190, 375, R5		
220#	0°F to 250°F	12"	.195	72"		190, 550, R5		ORS-HMB = Oil Resistant Hot Asphalt
220#	-25°F to 400°F	12"	.195	48"		190, 550, R5		
220#	-25°F to 700°F	12"	.195	72"		190, 550, R5		
220#	0°F to 350°F	12"	.195	72"		190, 550, R5		Poly = Polyester
330#	0°F to 350°F	18"	.215	72"		190, 550, R5		
330#	-25°F to 400°F	18"	.232	72"		190, 550, R5 <sup>1/2</sup>		PU = Polyurethane
330#	-25°F to 700°F	18"	.232	48"		190, 550, R5		
								PVC = Poly Vinyl Chloride
220#	-40°F to 225°F	12"	.130	60"		125, 20	2	
105#	-25°F to 225°F	4"	.130	72"		125, 7	1	RMV = Rubber Modified Vinyl
150#	-25°F to 225°F	4"	.120	72"		125, 7	1	
150#	-25°F to 225°F	4"	.120	72"		62, 7	25LP	RT = Roughtop
135#	-40°F to 250°F	4"	.100	72"		125, 20	2	
150#	0°F to 250°F	3 <sup>1/2</sup> "	.105	72"		62, 7	2	SC = Static Conductive
135#	0°F to 250°F	4"	.130	72"		125, 20	2	
120#	20°F to 180°F	2 <sup>1/2</sup> "	.100	72"		125, 15	1	Tex = Texture
150#	-40°F to 250°F	3 <sup>1/2</sup> "	.115	72"		125, 15	2	
150#	-20°F to 225°F	4"	.100	72"		125, 15	2	

## BELT SPECIFICATION CHART

Spec#	Part#	Description	Plies	Color	Overall Thickness	Covers
<b>IMPRESSION TOP BELTS continued</b>						
#56	20049012	2 Ply 160 Black Steep-Lok x BB	2	black	19/64"	SBR
#61A	20035506	PVC 120 Black RT x FS	1	black	11/64"	PVC
#62A	20033600	PVC 100 Black Bucket Top OR x FS	1	black	15/64"	PVC
#62B	20035525	PVC 120 Black Crescent Top x FS	1	black	15/64"	PVC
#185	20035530	PVC 200 Black Crescent Top x FS	1	black	5/16"	PVC
#63B	20034800	PVC 120 Black Z Top OR x FS	1	black	15/64"	PVC
#242	20034605	PVC 150 Black CT II x Brush	1	black	1/4"	PVC
#204	20035527	PVC 150 Black Crescent Top x Brush	1	black	1/4"	PVC
#99	20028700	3 Ply Poly 105 White Tyler Wire x FS	3	white	1/8"	Nitrile
#102	20028506	3 Ply Poly 135 White Nitrile Meat Cleat x FS	3	white	9/64"	Nitrile
#233	24005980	2 Ply Poly Inverted Pyramid PVC Top Cover x BB	2	white	3/32"	PVC
<b>SLITTABLE CHEVRON BELTS</b>						
#57A	20029603	2 Ply 220 1/8 x 1/16 Durocleat GR2	2	black	5/16"	SBR
#58	20029601	2 Ply 220 1/8 x 1/16 Durocleat MOR	2	black	5/16"	Nitrile Blend
#178	20029605	3 Ply 330 1/8 x 1/16 Durocleat GR2	3	black	3/8"	SBR
#59B	20029615	3 Ply 330 1/8 x 1/16 Durocleat MOR	3	black	3/8"	Nitrile Blend
#56B	20029602	2 Ply 220 1/8 x Bare Durocleat MOR	2	black	1/4"	Nitrile Blend
#247	20029607	3 Ply 330 5/32 x Bare Durocleat MOR	3	black	9/16"	Nitrile Blend
<b>PVC - RMV BELTS</b>						
#60	20032710	2 Ply 60 Matte PVC Checkout Counter x BB	2	black	5/64"	PVC
#60A	20032940	2 Ply 100 Black RMV x FS	2	black	7/64"	Rubber/PVC
#60B	20032945	3 Ply 150 Black RMV x FS	3	black	1/8"	Rubber/PVC
#61A	20035506	PVC 120 Black RT x FS	1	black	11/64"	PVC
#62A	20033600	PVC 100 Black Bucket Top OR x FS	1	black	15/64"	PVC
#62B	20035525	PVC 120 Black Crescent Top x FS	1	black	15/64"	PVC
#55A	20034603	PVC 120 Black CT II OR x FS	1	black	1/4"	PVC
#63B	20034800	PVC 120 Black Z Top OR x FS	1	black	15/64"	PVC
#242	20034605	PVC 150 Black CT II x Brush	1	black	1/4"	PVC
#204	20035527	PVC 150 Black Crescent Top x Brush	1	black	1/4"	PVC
#219	20034520	PVC 120 Green RT x FS	1	green	13/64"	PVC
#64A	20035498	PVC 100 Black Cover x FS	1	black	7/64"	PVC
#64B	20035508	PVC 120 Black FS x Brush	1	black	1/8"	PVC
#65	20035501	PVC 120 Black Cover x FS	1	black	9/64"	PVC
#65A	20035502	PVC 120 Black OR Cover x FS	1	black	9/64"	PVC
#65B	20035499	PVC 100 Black OR Cover x FS	1	black	7/64"	PVC
#66	20035500	PVC 120 Black CBS	1	black	11/64"	PVC
#66A	20038199	PVC 150 Black OR CBS	1	black	13/64"	PVC
#67	20038200	PVC 150 Black Cover x FS	1	black	11/64"	PVC
#67A	20038207	PVC 200 Black Cover x FS	1	black	15/64"	PVC
#69A	20038206	PVC 200 Black ORSC CBS	1	black	1/4"	PVC
#67B	20038509	2 PLY PVG 220 White 1/16 X 1/16 SC	2	white	1/4"	PVG
#69B	20038500	PVC 250 Black ORSC CBS	1	black	5/16"	PVC
<b>PVC ELEVATOR BELT</b>						
#66A	20038199	PVC 150 Black OR CBS	1	black	13/64"	PVC
#70A	20038208	PVC 200 White OR CBS	1	white	1/4"	PVC
#69A	20038206	PVC 200 Black ORSC CBS	1	black	1/4"	PVC
#69B	20038500	PVC 250 Black ORSC CBS	1	black	5/16"	PVC
#72	20039000	PVC 350 Black ORSC CBS	1	black	5/16"	PVC
#73	20040009	PVC 450 Black ORSC CBS	1	black	11/32"	PVC

Working Tension PIW	Temp Range	Minimum Pulley Dia	Weight PIW	Maximum Roll Width	FDA USDA	Flexco #	Clipper #	DESCRIPTION ABBREVIATION KEY
160#	-25°F to 225°F	4"	.095	60"		125, 7	1	BB = Bare Back Brush = Brushed Bottom C = Conveyor CBS = Cover Both Sides CD = Cold CR = Cross Rigid CT II = Chevron Top II E = Elevator FR = Fire Retardant FS = Friction Surface GR 2 = Grade 2 (SBR) H = Hot IMPG = Impregnated MOR = Moderate Oil Resistance MRT = Mini Roughtop MSHA = Mine Safety Health Act MSK = Mini Skim Coat OR = Oil Resistant ORS-HMB = Oil Resistant Hot Asphalt Poly = Polyester PU = Polyurethane PVC = Poly Vinyl Chloride RMV = Rubber Modified Vinyl RT = Roughtop SC = Static Conductive Tex = Texture
120#	20°F to 180°F	2 1/2"	.100	72"		125, 15	1	
100#	20°F to 180°F	2"	.085	72"		125, 7	1SP	
120#	20°F to 180°F	2"	.085	72"		62, 7	1SP	
200#	20°F to 180°F	4"	.130	72"		187, 27		
120#	20°F to 180°F	2 1/2"	.090	72"		125, 7	1	
150#	20°F to 180°F	3"	.110	72"		125, 20	2	
150#	20°F to 180°F	3"	.110	72"		125, 20	2	
105#	0°F to 250°F	2 1/2"	.060	72"		125, 7	1	
135#	0°F to 250°F	3 1/2"	.085	72"		125, 15	2SP	
56#	20°F to 180°F	1 1/2"	.047	78"	*	62, 1	25LP	
220#	-25°F to 225°F	12"	.210	72"		190, 375, R5		
220#	0°F to 250°F	12"	.210	72"		190, 375, R5		
330#	-25°F to 225°F	18"	.260	72"		190, 550, R5 1/2		
330#	0°F to 250°F	18"	.250	72"		190, 550, R5 1/2		
220#	0°F to 250°F	10"	.185	72"		190, 375, R5		
330#	0°F to 250°F	16"	.225	72"		190, 550, R5		
60#	20°F to 180°F	2"	.047	72"		1	25LP	
100#	20°F to 180°F	1 1/2"	.070	72"		62, 7	1SP	
150#	20°F to 180°F	3"	.080	72"		62, 7	1SP	
120#	20°F to 180°F	2 1/2"	.100	72"		125, 15	1	
100#	20°F to 180°F	2"	.085	72"		125, 7	1SP	
120#	20°F to 180°F	2"	.085	72"		62, 7	1SP	
120#	20°F to 180°F	2 1/2"	.088	72"		125, 7	1	
120#	20°F to 180°F	2 1/2"	.090	72"		125, 7	1	
150#	20°F to 180°F	3"	.110	72"		125, 20	2	
150#	20°F to 180°F	3"	.110	72"		125, 20	2	
120#	20°F to 180°F	2 1/2"	.100	72"		125, 15	1	
100#	20°F to 180°F	2"	.065	72"		62, 7	25LP	
120#	20°F to 180°F	2"	.050	72"		125, 15	1	
120#	20°F to 180°F	2"	.075	72"		125, 15	1	
120#	20°F to 180°F	2"	.075	72"		125, 15	1	
100#	20°F to 180°F	2"	.070	72"		62, 7	1SP	
120#	20°F to 180°F	2 1/2"	.090	72"		125, 20	2	
150#	20°F to 180°F	4"	.100	72"		187, 25	3	
150#	20°F to 180°F	3"	.100	72"		125, 20	2	
200#	20°F to 180°F	6"	.117	72"		187, 27	4	
200#	20°F to 180°F	6"	.142	72"		187, 27, R5	4	
220#	20°F to 180°F	8"	.126	72"		187, 27, 140, 375, R5	4	
250#	20°F to 180°F	8"	.150	72"		140, 550, R5, 35		
150#	20°F to 180°F	4"	.100	72"		187, 25	3	
200#	20°F to 180°F	6c, 8e	.142	72"		187, 27, R5	4	
200#	20°F to 180°F	6"	.142	72"		187, 27, R5	4	
250#	20°F to 180°F	8"	.150	72"		140, 550, R5, 35		
350#	20°F to 180°F	8c, 12e	.158	72"		140, 550, R5, 45		
450#	20°F to 180°F	10c, 14e	.175	72"		190, 550, R5, 45		



## BELT SPECIFICATION CHART

Spec#	Part#	Description	Plies	Color	Overall Thickness	Covers
<b>WHITE FOOD BELT</b>						
#91	20028503	2 Ply Poly 70 White Nitrile 3/64 x FS	2	white	3/32"	Nitrile
#91B	20032950	2 Ply 100 White RMV x FS	2	white	7/64"	Rubber/PVC
#91C	20032951	3 Ply 150 White RMV x FS	3	white	9/64"	Rubber/PVC
#221	20028507	Polymate 135 White RMP COS	1	white	9/64"	PVC
#92	20028505	3 Ply Poly 105 White Nitrile 3/64 x FS	3	white	1/8"	Nitrile
#92A	20028504	3 Ply PNT 150 White Nitrile 3/64 x FS	3	white	5/32"	Nitrile
#94A	20035400	PVC 100 White Cover x MSK	1	white	7/64"	PVC
#239	20035535	PVC 120 White Crescent Top x FS	1	white	15/64	PVC
#95	20035496	PVC 120 White Cover x MSK	1	white	9/64"	PVC
#95B	20033550	PVC 120 White CT II OR x MSK	1	white	7/32"	PVC
#70A	20038208	PVC 200 White OR CBS	1	white	1/4"	PVC
#98	20028650	3 Ply Poly 105 White Butyl 1/32 x FS	3	white	7/64"	Butyl
#99	20028700	3 Ply Poly 105 White Tyler Wire x FS	3	white	1/8"	Nitrile
#102	20028506	3 Ply Poly 135 White Nitrile Meat Cleat x FS	3	white	9/64"	Nitrile
#104	20028625	3 Ply Poly 105 White Teflon x FS	3	white	3/32"	Teflon
#223	24041040	2 Ply White Urethane x IMPG Bottom SC	2	white	1/16"	Urethane
#224	24041010	2 Ply White PVC x IMPG Bottom SC	2	white	5/64"	PVC
#252	20032953	3 Ply 150 White RMV CRSC x BB	3	white	11/64"	RMV
#230	20038225	4 Ply 200 White RMV CRSC x BB	4	white	7/32"	Rubber/PVC
#67B	20038509	2 PLY PVG 220 White 1/16 X 1/16 SC	2	white	1/4"	PVG
#222	24041030	1 Ply White Urethane x IMPG Bottom SC	1	white	1/32"	Urethane
<b>PACKAGE HANDLING / LIGHT DUTY BELT</b>						
#106	20030518	3 Ply 105 Black FS x FS	3	black	1/8"	SBR
#107	20031018	3 Ply 105 Tan FS x FS	3	tan	9/64"	SBR
#109	20031506	4 Ply 140 Tan FS x FS	4	tan	11/64"	SBR
#110	20032700	3 Ply Brown Nitrile FS x FS	3	brown	5/64"	Nitrile
#111	20032650	5 Ply Brown Nitrile FS x FS	5	brown	7/64"	Nitrile
#203	20032690	7 Ply Brown Nitrile FS x FS	7	brown	5/32"	Nitrile Blend
#195	20032499	3 Ply PNT 150 Tan Nitrile Slip Top x FS	3	tan	1/8"	Nitrile
#113	20032500	4 Ply Tan Slip Top x FS	4	tan	1/8"	SBR
#114	20032550	3 Ply Hot Stock and Water	3	white	9/64"	SBR
#118A	20031515	4 Ply 200 Black Nitrile FS x FS	2	black	9/64"	Nitrile
#118B	20030515	2 Ply 220 Tan BB x BB w/Black Skim	2	tan	5/32"	SBR
<b>THERMOPLASTIC BELT</b>						
#244	20040550	ATI 150 Black Urethane x FS	1	black	3/16"	Urethane
#249	24041050	2 Ply Green Urethane x IMPG SC	2	green	1/16"	Urethane
#250	24041070	2 Ply Green PVC Roughtop x BB	2	green	7/32"	PVC
#251	24041090	2 Ply Black PVC SC x BB	2	black	3/32"	PVC
#229	24009752	2 Ply Green PVC SC x BB	2	green	5/64"	PVC
#223	24041040	2 Ply White Urethane x IMPG Bottom SC	2	white	1/16"	Urethane
#224	24041010	2 Ply White PVC x IMPG Bottom SC	2	white	5/64"	PVC
#252	20032953	3 Ply 150 White RMV CRSC x BB	3	white	11/64"	RMV
#230	20038225	4 Ply 200 White RMV CRSC x BB	4	white	7/32"	Rubber/PVC
#253	20032955	3 Ply 150 Black RMV CRSC x BB	3	black	11/64"	Poly/Mono
#231	20032957	4 Ply 200 Black RMV CRSC x BB	4	black	7/32"	Rubber/PVC
#222	24041030	1 Ply White Urethane x IMPG Bottom SC	1	white	1/32"	Urethane
#60	20032710	2 Ply 60 Matte PVC Checkout Counter x BB	2	black	5/64"	PVC
<b>TRANSMISSION BELT</b>						
#240	24041195	HAM-5P	3	green	1/32"	Nitrile
#241	24041193	F-1	2	green	3/64"	Nitrile
#236	24005513	XH500-4		blue	5/32"	Nitrile
#237	24005512	XH500-5		blue	13/64"	Nitrile
#238	24005514	XH500-6		blue	15/64"	Nitrile

Working Tension PIW	Temp Range	Minimum Pulley Dia	Weight PIW	Maximum Roll Width	FDA USDA	Flexco #	Clipper #	DESCRIPTION ABBREVIATION KEY
70#	0°F to 250°F	2"	.050	72"		62, 7	1SP	<b>BB =</b> Bare Back  <b>Brush =</b> Brushed Bottom  <b>C =</b> Conveyor  <b>CBS =</b> Cover Both Sides  <b>CD =</b> Cold  <b>CR =</b> Cross Rigid  <b>CT II =</b> Chevron Top II  <b>E =</b> Elevator  <b>FR =</b> Fire Retardant  <b>FS =</b> Friction Surface  <b>GR 2 =</b> Grade 2 (SBR)  <b>H =</b> Hot  <b>IMPG =</b> Impregnated  <b>MOR =</b> Moderate Oil Resistance  <b>MRT =</b> Mini Roughtop  <b>MSHA =</b> Mine Safety Health Act  <b>MSK =</b> Mini Skim Coat  <b>OR =</b> Oil Resistant  <b>ORS-HMB =</b> Oil Resistant Hot Asphalt  <b>Poly =</b> Polyester  <b>PU =</b> Polyurethane  <b>PVC =</b> Poly Vinyl Chloride  <b>RMV =</b> Rubber Modified Vinyl  <b>RT =</b> Roughtop  <b>SC =</b> Static Conductive  <b>Tex =</b> Texture
100#	20°F to 180°F	1 1/2"	.056	72"		62, 7	1SP	
150#	20°F to 180°F	3"	.083	72"		125, 15	1	
135#	20°F to 180°F	2 1/2"	.070	60"		7	1	
105#	0°F to 250°F	3"	.070	72"		125, 7	1	
150#	0°F to 250°F	3 1/2"	.080	72"		125, 20	2	
100#	20°F to 180°F	1 1/2"	.050	72"		62, 7	1SP	
120#	20°F to 180°F	2"	.085	72"		125, 15, 62, 7	1SP	
120#	20°F to 180°F	2 1/2"	.070	72"		125, 15	1	
120#	20°F to 180°F	2 1/2"	.072	72"		125, 15	1	
200#	20°F to 180°F	6c, 8e	.142	72"		187, 27, R5	4	
105#	-65°F to 300°F	1 1/2"ht, 4"cl	.053	72"		62, 7	1SP	
105#	0°F to 250°F	2 1/2"	.060	72"		125, 7	1	
135#	0°F to 250°F	3 1/2"	.085	72"		125, 15	2SP	
105#	0°F to 275°F	2 1/2"	.052	54"		62, 7	1SP	
46#	20°F to 180°F	1/2"	.025	118"	*	00,	2SP, UCM36 SP	
70#	20°F to 180°F	1"	.042	118"	*	62, 1	25LP	
150#	20°F to 180°F	3"	.083	72"		20, RS125	2	
200#	20°F to 180°F	8"	.140	72"		187, 27		
220#	20°F to 180°F	8"	.126	72"		187, 27, 140, 375, R5	4	
17#	20°F to 180°F	1/4"	.015	118"	*		UCM36 XSP	
105#	-40°F to 250°F	3"	.057	72"		125, 15	2SP	
105#	-40°F to 250°F	3"	.087	72"		125, 15	1	
140#	-40°F to 250°F	6"	.110	72"		125, 20	2	
69#	0°F to 250°F	3/4"	.037	72"		62, 1	25LP	
115#	0°F to 250°F	1 1/2"	.065	72"		62, 7	1SP	
84#	0°F to 250°F	3"	.094	72"		20	2	
135#	0°F to 250°F	3 1/2"	.070	72"		125, 7		
92#	-20°F to 250°F	3"	.070	72"		125, 7	1	
105#	-40°F to 250°F	3 1/2"	.072	72"		125, 15	1	
200#	0°F to 250°F	3"	.070	72"		125, 15	1	
220#	-25°F to 225°F	8"	.075	60"		125, 15, R2	1	
150#	20°F to 180°F	2 1/2"	.090	72"		125, 20		
70#	20°F to 180°F	5/8"	.025	72"		hot vlc, cold bond	25LP	
70#	20°F to 180°F	2 1/2"	.077	72"		62, hot vlc, cold bond	25LP, 36LL	
70#	20°F to 180°F	1 1/2"	.042	72"		hot vlc, cold bond	25LP, UCM36 SP	
70#	20°F to 180°F	1 5/8"	.040	118"		62, 1	25LP	
46#	20°F to 180°F	1/2"	.025	118"	*	00,	2SP, UCM36 SP	
70#	20°F to 180°F	1"	.042	118"	*	62, 1	25LP	
150#	20°F to 180°F	3"	.083	72"		20, RS125	2	
200#	20°F to 180°F	8"	.140	72"		187, 27		
150#	20°F to 180°F	3"	.083	72"		20, RS125	2	
200#	20°F to 180°F	8"	.140	72"		187, 27		
17#	20°F to 180°F	1/4"	.015	118"	*		UCM36 XSP	
60#	20°F to 180°F	2"	.047	72"		1	25LP	
	0°F to 212°F	5/8"	.014	45"		thermofix skived splice		
	0°F to 212°F	1"	.021	45"		thermofix skived splice		
	0°F to 250°F	1 1/2"	.158	48"		thermofix skived splice		
	0°F to 250°F	2 1/4"	.197	48"		thermofix skived splice		
	0°F to 250°F	2 1/2"	.236	48"		thermofix skived splice		